

# CTech™ ViPER® ANLYTX Software

---

## User Guide



DOC0343 eRev. 1.0 8/23/2024

[repligen.com](https://repligen.com)

© 2024 Repligen Corporation. All rights reserved. The trademarks mentioned herein are the property of Repligen Corporation and/or its affiliate(s) or their respective owners.



The information contained in this document is subject to change without notice.

With respect to documentation accompanying Product Repligen makes no warranty, express or implied. Any and all warranties related to the documentation accompanying Product are expressly disclaimed. Customer shall refer to the terms and conditions of sale governing the transaction for any and all warranties for the Product.

Repligen Corporation shall not be liable for errors contained herein or for incidental or consequential damages in connection with the furnishing, performance, or use of this material.

No part of this document may be photocopied, reproduced, or translated to another language without the prior written consent of Repligen Corporation.

Products are not intended for diagnostic or therapeutic use or for use in vivo with humans or animals.

For further information, please contact Repligen Corporation at [www.repligen.com](http://www.repligen.com).

©2024 Repligen Corporation. All rights reserved. The trademarks mentioned herein are the property of Repligen Corporation and/or its affiliate(s) or their respective owners.

### **Customer Support**

[analytics-support@repligen.com](mailto:analytics-support@repligen.com)

(908) 707-1201

### **Repligen Corporation**

Process Analytics Offices and Manufacturing Facility

685 Route 202/206

Bridgewater, NJ 08807, USA

[www.repligen.com](http://www.repligen.com)

## Contents

<b>1. Introduction</b>	<b>7</b>
1.1 System Requirements	7
<b>2. Getting Started</b>	<b>8</b>
2.1 ViPER Startup	8
2.2 Login (SecureVPT™ Users Only)	8
2.3 Homepage	8
2.4 My Applications	8
2.5 Help	9
2.6 Admin Settings	9
2.7 SecureVPT™ Settings	9
2.8 Audit Log	9
<b>3. Applications</b>	<b>11</b>
3.1 Manual Controls	11
3.2 Validate VPT	14
3.3 Quick Slope	18
3.4 Quick Survey	23
3.5 AAV (Adeno-Associated Virus)	27
3.6 ADC (Antibody-Drug Conjugate)	32
3.7 Quick Kinetics	37
3.8 Kinetic Survey	42
<b>4. Feature Descriptions</b>	<b>47</b>
4.1 Report Wizard	47
4.2 Scatter Correction	48
4.3 SoloVPE with Cary 60 Procedures	50
4.3.1 Coupler Check	50
4.3.2 Quick Check	53
4.3.3 System Suitability Test	54
4.4 FlowVPX with Cary 60 Procedures	54
4.4.1 Coupler Check	54
4.4.2 Transmission Check	56
4.4.3 Quick Check	57
4.4.4 System Suitability Test	57
4.4.5 Loading the Flow Cell	59
4.4.6 Unloading the Flow Cell	60
4.5 FlowVPX with Beams Procedures	61
4.5.1 Quick Check	62
4.5.2 System Suitability Test	63
4.5.3 Loading the Flow Cell	65
4.5.4 Unloading the Flow Cell	66
<b>5. Admin Settings</b>	<b>68</b>
5.1 Devices	68
5.2 App Configuration	69
5.3 Usage Report	69
5.4 Data Store	70
<b>6. SecureVPT™ Settings</b>	<b>71</b>
6.1 User Types	71
6.2 User Management	72
6.3 Feature Access	73
6.4 eSign App Configurations	73
6.5 eSign User Configurations	74
6.6 Method Library	74
<b>7. Audit Log</b>	<b>75</b>

<b>8. Advanced .....</b>	<b>76</b>
8.1 LDAP Configuration .....	76
8.2 SQL Server Database Architecture .....	76
8.3 VPT OPC Server .....	76
<b>9. Best Practices &amp; Troubleshooting .....</b>	<b>77</b>
9.1 Backing Up Data .....	77
9.2 Frequently Asked Questions .....	77
9.3 Troubleshooting .....	79
9.4 Additional Resources.....	79
<b>Glossary.....</b>	<b>81</b>
<b>Index.....</b>	<b>84</b>

**List of tables**

Table 1. Compatibility of Applications with VPT Instruments.....	11
Table 2. Manual Controls Navigation Bar Icons .....	12
Table 3. Validate VPT Navigation Bar Icons.....	15
Table 4. Quick Slope Navigation Bar Icons .....	19
Table 5. Quick Slope Graphing Tools .....	22
Table 6. Quick Survey Navigation Bar Icons .....	23
Table 7. Quick Survey Graphing Tools .....	26
Table 8. AAV Navigation Bar Icons .....	27
Table 9. AAV Graphing Tools .....	31
Table 10. ADC Navigation Bar Icons .....	32
Table 11. ADC Graphing Tools .....	36
Table 12. Quick Kinetics Navigation Bar Icons.....	37
Table 13. Quick Kinetics Graphing Tools .....	41
Table 14. Kinetic Survey Navigation Bar Icons .....	42

**List of figures**

Figure 1. Example of the ViPER homepage .....	8
Figure 2. Admin Settings tabs .....	9
Figure 3. SecureVPT Settings tabs .....	9
Figure 4. Audit Log menu.....	10
Figure 5. Example of the My Applications page .....	11
Figure 6. Manual Controls application: menus and sections. ....	12
Figure 7. Method Input Menu .....	13
Figure 8. Instrument Controls .....	13
Figure 9. Manual Controls Graph Viewer .....	14
Figure 10. Validate VPT application: menus and sections.....	15
Figure 11. Example Validate VPT Log .....	16
Figure 12. Example System Suitability Log .....	16
Figure 13. Example vProtocol Log .....	17
Figure 14. Validate VPT Instrument Controls .....	17
Figure 15. Quick Slope application: menus and sections. ....	18
Figure 16. Quick Slope Method Input Menu .....	20
Figure 17. Quick Slope Instrument Controls .....	21
Figure 18. Quick Slope Sample Name Field .....	21
Figure 19. Quick Slope Graph Viewer .....	22
Figure 20. Quick Survey application: menus and sections. ....	23
Figure 21. Quick Survey Method Input Menu .....	24
Figure 22. Quick Survey Instrument Controls .....	25
Figure 23. Quick Survey Sample Name Field .....	25

Figure 24. Quick Survey Graph Viewer .....	26
Figure 25. AAV application: menus and sections. ....	27
Figure 26. AAV Method Input Menu .....	29
Figure 27. AAV Instrument Controls.....	30
Figure 28. AAV Sample Field.....	30
Figure 29. AAV Graph Viewer .....	31
Figure 30. ADC application: menus and sections .....	32
Figure 31. ADC Method Input Menu .....	34
Figure 32. ADC Instrument Controls.....	35
Figure 33. ADC Sample Field.....	35
Figure 34. ADC Graph Viewer .....	36
Figure 35. Quick Kinetics application: menus and sections. ....	37
Figure 36. Quick Kinetics Method Input Menu .....	39
Figure 37. Quick Kinetics Instrument Controls.....	40
Figure 38. Quick Kinetics Sample Name Field .....	40
Figure 39. Quick Kinetics Graph Viewer .....	41
Figure 40. Kinetic Survey application: menus and sections. ....	42
Figure 41. Kinetic Survey Method Input Menu .....	44
Figure 42. Kinetic Survey Instrument Controls.....	44
Figure 43. Kinetic Survey Sample Name Field .....	45
Figure 44. Kinetic Survey Graph Viewer .....	45
Figure 45. Report Wizard example .....	47
Figure 46. Graphical illustration of single-wavelength scatter correction.....	48
Figure 47. Graphical illustration of dual-wavelength scatter correction .....	49
Figure 48. Graphical illustration of Dual LN and Multi LN scatter correction .....	50
Figure 49. Validate VPT Instrument Controls .....	51
Figure 50. Coupler Check window prompt.....	51
Figure 51. Disconnect Delivery Fiber from Translation Stage.....	51
Figure 52. Connect Delivery Fiber to Transmission Tool.....	52
Figure 53. Connect Transmission Tool to Translation Stage.....	52
Figure 54. Coupler Check window with Coupler Check results.....	52
Figure 55. Reconnect Delivery Fiber to Translation Stage.....	52
Figure 56. Prepare for Quick Check window prompt and requirements.....	53
Figure 57. Passed Quick Check.....	53
Figure 58. Failed Quick Check.....	53
Figure 59. Reference Standard Information Fields .....	54
Figure 60. Coupler Check Button in Instrument Control Menu .....	55
Figure 61. Coupler Check Instructions (Cary 60) .....	55
Figure 62. Coupler Check window with Coupler Check results.....	56
Figure 63. Transmission Check Button in Instrument Control Menu.....	56
Figure 64. System Suitability Button in Instrument Control Menu.....	57
Figure 65. Reference Standard Information Fields .....	58
Figure 66. Flow Cell Loading Instructions.....	59
Figure 67. Correct FX Connector Nut Orientation.....	60
Figure 68. Unload Flow Cell Confirmation Prompt .....	61
Figure 69. Flow Cell Unloading Using the Cary 60 Light Source.....	61
Figure 70. Quick Check Button in Instrument Control Menu .....	62
Figure 71. Quick Check Loading Window .....	62
Figure 72. Quick Check Results.....	63
Figure 73. Correct Beams FX connector Nut Orientation .....	64
Figure 74. Flow Cell Loading Instructions.....	65
Figure 75. Unload Flow Cell Confirmation Prompt .....	66
Figure 76. Flow Cell Unloading Using the Beams Light Source .....	66
Figure 77. Device Settings .....	68

Figure 78. Display Settings.....	69
Figure 79. App Configuration .....	69
Figure 80. Usage Report .....	70
Figure 81. Data Store .....	70
Figure 82. SecureVPT Settings Menu: User Types.....	71
Figure 83. Feature Access .....	73
Figure 84. eSign App Configuration .....	74
Figure 85. eSign User Configuration .....	74
Figure 86. Method Library .....	74
Figure 87. VPT OPC Server .....	76

## Abbreviations

AAV	Adeno-Associated Virus
ADC	Antibody-Drug Conjugate
DAQ	Data Acquisition
DVA	Detector Validation Adapter
EU	European Union
FDA	Food and Drug Administration
GMP	Good Manufacturing Practices
HMI	Human-Machine Interface
IQ	Installation Qualification
LDAP	Lightweight Directory Access Protocol
NIST	National Institute of Standards and Technology
OPC-UA	Open Platform Communications—Unified Architecture
OQ	Operational Qualification
PC	Personal Computer
PDF	Portable Document Format
PLC	Programmable Logic Controller
SSMS	SQL Server Management Studio
USP	United States Pharmacopeia
VPT	Variable Pathlength Technology
XSA	(FlowVPX) System Suitability Adapter

## 1. Introduction

CTech™ ViPER® ANALYTIX is an application-based software program for operating Variable Pathlength Technology (VPT) systems.

The ViPER software is compatible with the following VPT spectrophotometer systems:

- CTech SoloVPE® with Cary 60 light source
- CTech FlowVPX® with Cary 60 light source
- CTech FlowVPX® with Beams™ light source

**Note:** The CTech FlowVPE® System is also compatible with ViPER software but not covered in this user guide. For more information, please contact a Repligen process analytics representative.

### 1.1 System Requirements

#### Software

ViPER ANALYTIX software requires the following applications:

- Microsoft .NET Framework 4.7 or later
- SQL Server Standard 2012 or SQL Server Express 2017
- Agilent Cary WinUV environment
- Google Chrome

#### Hardware

ViPER ANALYTIX software has been validated for use with the following PC specifications:

##### Lenovo ThinkPad T460s

- Intel Core i7 (Dual Core, 2.6GHz, 3MB)
- 20GB 1600MHz DDR Non-ECC RAM
- 500GB 7200rpm Hard Disk Drive
- Intel Integrated Graphics
- Windows® 10 64-bit
- Chrome 64-bit V.75 or later

##### Dell Rugged Latitude 7424

- Intel Core i7-8650U 1.90GHz
- 16GB DDR4 RAM
- 128GB Solid State Hard Drive
- Windows 10 Pro 64-bit
- Chrome 64-bit V.75 or later

VPT instruments are shipped with a compatible PC. Users may supply their own PC if desired, provided it meets the following requirements:

- Windows® 10 Professional (64 bit)
- Intel® Processor i5 (i7 recommended)
- 8 GB RAM (16 GB recommended)
- 250 GB Storage (solid state recommended)
- Microsoft .NET Framework 4.7 or later
- 4 USB Ports
- Display Port 1.2, HDMI 1.4, VGA, or DVI

## 2. Getting Started

### 2.1 ViPER Startup

Upon launching ViPER software, a window will open in Google Chrome containing the ViPER interface. The VPT OPC Server application will also launch. This application is a communication hub that links the VPT instrument, database, and user interface through an open platform communications (OPC-UA) server. VPT OPC Server must be running in order to operate VPT instruments using ViPER software. See Section 8.3 for details.



**CAUTION:** Do not close VPT OPC Server while using ViPER.

### 2.2 Login (SecureVPT™ Users Only)

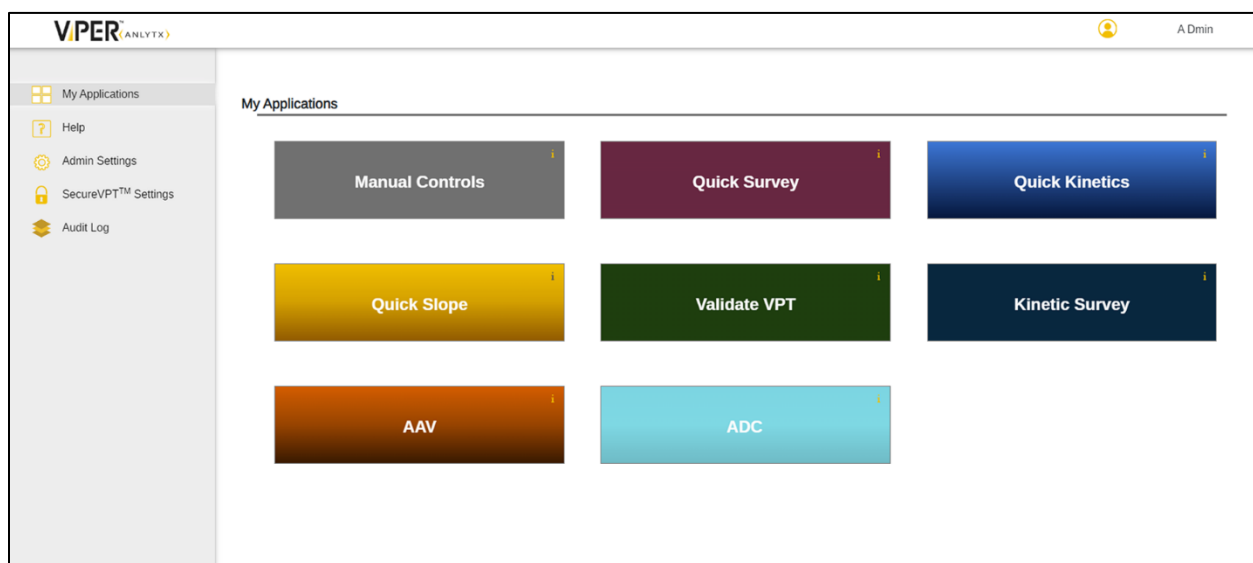
Users who have purchased the SecureVPT add-on will be prompted to log in upon startup. Enter the username in the field provided and click Next. Then enter the password in the field provided, and click Log In. See section 2.7 or Chapter 6 for more information on the SecureVPT package.

**Note:** ViPER Software has two authentication types that determine how users log in: LDAP network authentication and ViPER local authentication. The software is set to ViPER local authentication by default. This setting can be changed in Admin Settings; see section 5.4 for details.

### 2.3 Homepage

The homepage allows access to applications and settings. Applications are displayed in a grid layout in the main area of the page, while settings are accessible in the left navigation menu. Some items in the left navigation pane are visible only to users with a certain role. For more information on user roles and permissions, see Section 6.

Figure 1. Example of the ViPER homepage



### 2.4 My Applications

The user's licensed applications are displayed here. To launch an application, click on the corresponding application in the main area of the page. See Section 3 for complete descriptions of each ViPER application.



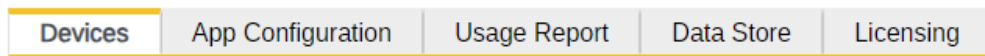
## 2.5 Help

Click Help to access the user guide. A PDF of the complete user guide can also be downloaded by visiting our online [Knowledge Base](#), under the Support page at [www.repligen.com](http://www.repligen.com), and searching by document title or ID (DOC0343).

## 2.6 Admin Settings

Admin settings will only be visible to users who have the Admin role in ViPER software. In this menu, Admin users manage devices, system configurations, and application defaults. Admins can save settings for devices by group or user level. Settings are grouped into five categories, marked by tabs at the top of the page:

Figure 2. Admin Settings tabs

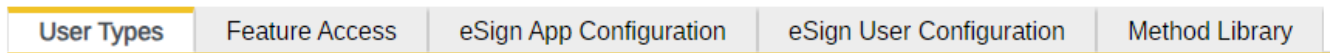


- **Devices:** All connected device details can be found here, as well as application settings.
- **App Configuration:** Set the default settings for each application.
- **Usage Report:** Review the usage of each device, last service date, average runs, and total sample runs.
- **Data Store:** Review database type, server name, and database name. Set the authentication type to either ViPER (local) or LDAP.
- **Licensing:** Add or remove ViPER licenses and enable or disable access to applications and software features.

## 2.7 SecureVPT™ Settings

SecureVPT™ is designed to support users following FDA 21 CFR Part 11 or EU GMP Annex 11 guidelines. SecureVPT settings will only be visible to users who have purchased the SecureVPT package and who have the SecureVPT Admin role in ViPER.

Figure 3. SecureVPT Settings tabs



- **User Types:** Assign ViPER roles for each user by Group Level and/or User Level. See section 6.1 for details.
- **User Management (local only):** Add, remove, or modify user accounts. This menu is only available when the authentication type is set to ViPER (local authentication).
- **Feature Access:** Select an application and enable or disable certain features for specific groups and users.
- **eSign App Configuration:** Assign eSignature points and the types of signatures required. eSignatures can be configured for each application independently.
- **eSign User Configuration:** Assign eSignature roles. eSignatures can be configured for each application independently.
- **Method Library:** Archive or restore methods for each application.

## 2.8 Audit Log

The Audit Log shows the securely logged data and activity. Users who have the Admin role will be able to see all users' activity; other users will see only their own individual user audit log.

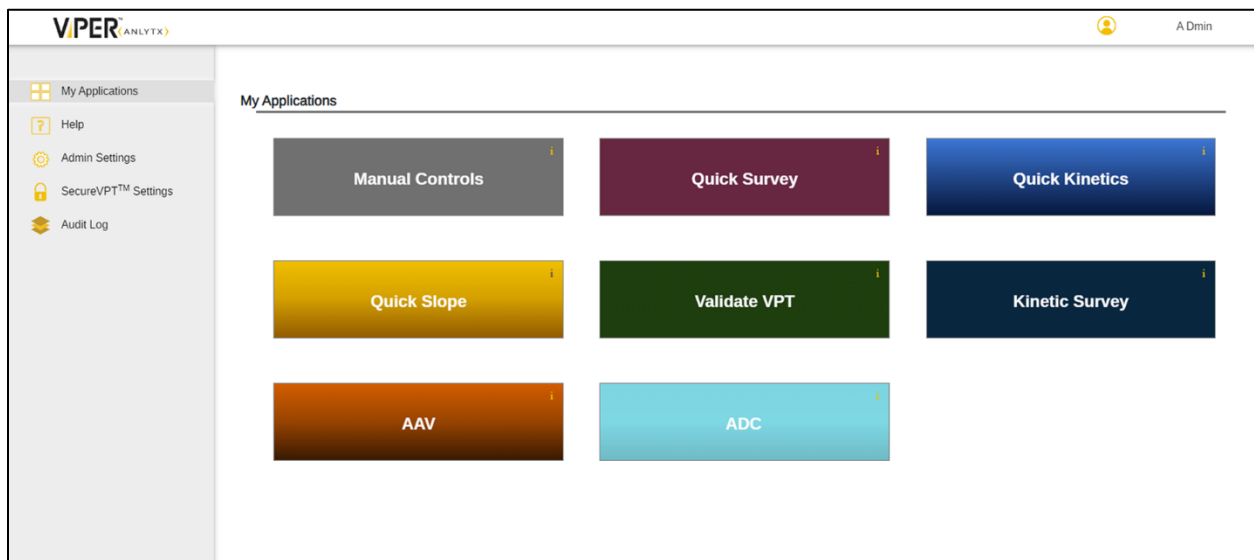
Figure 4. Audit Log menu

Audit Log Viewer								
<span style="float: right;">Export Columns ↻</span>								
All Users   All Devices   All Apps   All Event Types   FEB 05 2024 - MAR 06 2024 <span style="float: right;">Reset</span> <span style="float: right;">&lt; 1 of 273 &gt;</span>								
Username	Device	App	Event Type	Action	Old Value	New Value	Reason	Time Stamp (America/New_York)
JSmith	DeviceName	App Name	Event Type	Description of the action performed	Previous value, if applicable	New value, if applicable	Reason behind action performed, if applicable	MON DD YYYY hh:mm:ss

### 3. Applications

This chapter contains descriptions of the available applications. In order to use an application, the application must be licensed by a Repligen Field Service Engineer. Contact Repligen Analytical Support to add applications to your ViPER package (email: [analytics-support@repligen.com](mailto:analytics-support@repligen.com); phone: +1 (908) 707-1201).

Figure 5. Example of the My Applications page



Some applications are compatible with only one type of VPT instrument. Table 1 shows compatibility between ViPER applications and VPT instruments.

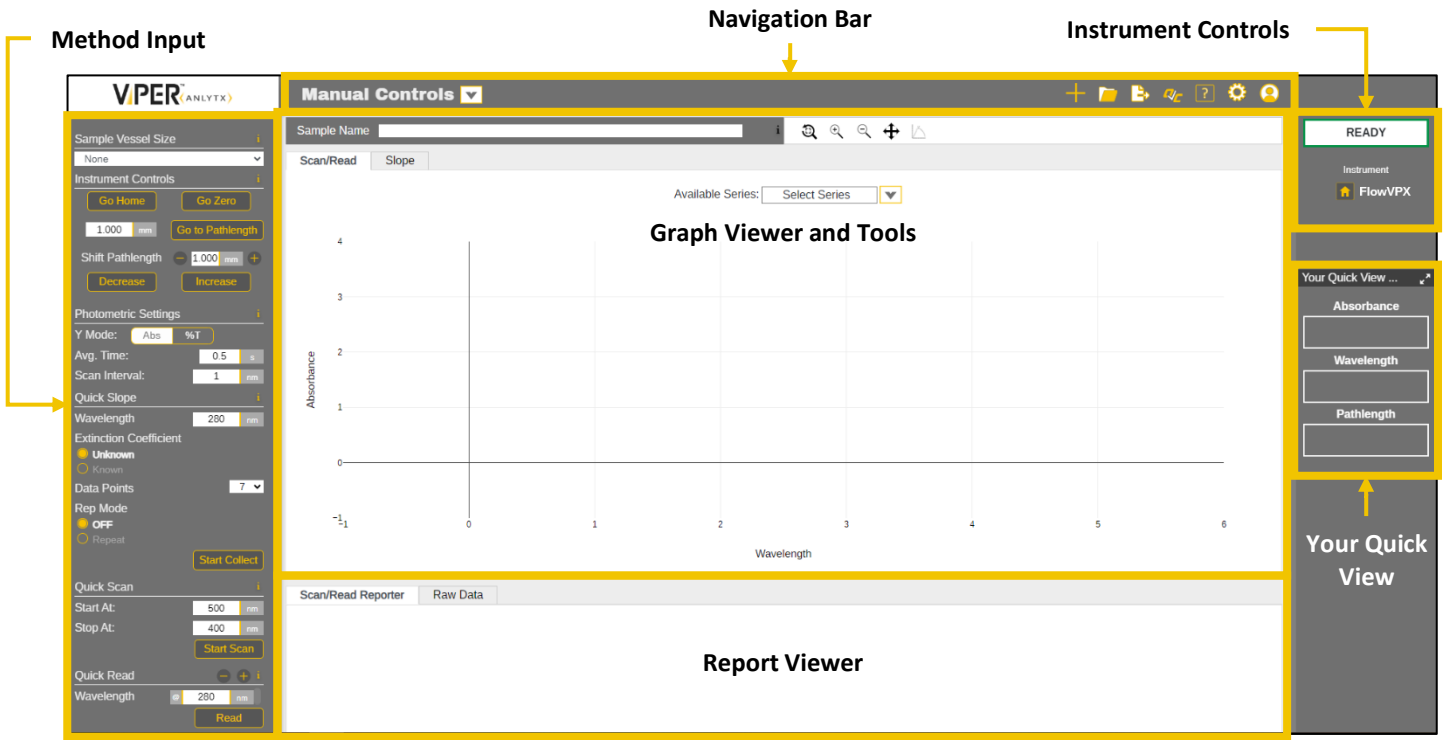
Table 1. Compatibility of Applications with VPT Instruments

Application	SoloVPE	FlowVPX
Manual Controls	✓	✓
Validate VPT	✓	✓
Quick Slope	✓	
Quick Survey	✓	
AAV (Adeno-Associated Virus)	✓	
ADC (Antibody-Drug Conjugate)	✓	
Quick Kinetics		✓
Kinetic Survey		✓

#### 3.1 Manual Controls

The Manual Controls application is compatible with all VPT devices. This application allows the user to operate supported VPT instruments with direct commands during installation, configuration, and maintenance procedures.

Figure 6. Manual Controls application: menus and sections.



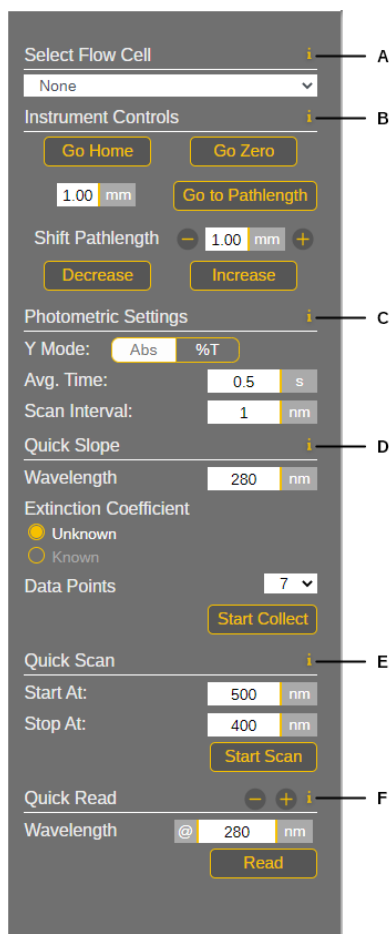
### Navigation Bar

The navigation bar can be found at the top of the application and contains the following actions:

Table 2. Manual Controls Navigation Bar Icons

Symbol	Name	Options	Description
	Available Apps	—	Click the dropdown menu to change to another application.
	Reset	Reset Run	Click to clear the data collected but keep the settings selected in the Method Input Menu.
	Open	Open Data	Click to access Open Data, which will display a data table with all previously collected data, organized by sample name, date saved, and name of user collecting the data. Users can search by sample name and filter by user or date. All data collected is autosaved by sample name.
	Export	Export Data	Exports the data collected as either an .xlsx (Excel) or .csv file. The file is saved to the default downloads location as determined by the user's Chrome settings.
		Export Report	Exports the report as a .pdf file. The file is saved to the default downloads location as determined by the user's Chrome settings.
	Quick Check	—	Opens the Validate VPT log and System Suitability log, showing recent performance tests. The user can then initiate a Quick Check and/or Coupler Check by clicking the buttons in the right panel.
	Help	User Guide	Click to access the user guide.
	Settings	Audit Log	Click to access the Audit Log.
	User Options	Log Out	Click to log out of ViPER.

Figure 7. Method Input Menu

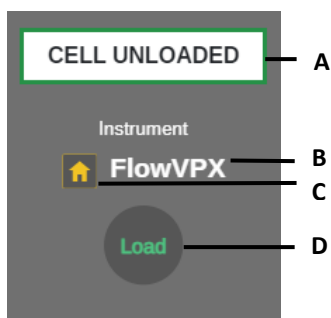


### Method Input Menu

The method input menu is the left panel in the application workspace. This menu allows the user to configure parameters for method creation and data collection. The following functions are displayed in Figure 7:

- A. **Sample Vessel (SoloVPE) / Select Flow Cell (FlowVPX):** Select the size of the sample vessel or Flow Cell that will be loaded into the instrument. It is required to select this field before using any of the functions below.
- B. **Instrument Control:** Send the VPT device to a precise position.
  - o **Go Home:** Send the device position to the maximum possible pathlength.
  - o **Go Zero:** Send the device to the Zero Position.
  - o **Go to Pathlength:** Send the device to the specified pathlength.
  - o **Shift Pathlength:** Increase or decrease the device by the specified distance.
  - o **Initialize Beams (Beams only):** Prompt VIPER software to connect to the Beams Source.
- C. **Photometric Settings:** Adjust the device measurement parameters.
  - o **Y-Mode:** Set the readout unit to absorbance units (Abs) or percent transmission (%T).
  - o **Avg. Time:** Set the averaging time of the detector or the duration over which the detector acquires data.
  - o **Scan Interval:** Set the wavelength step size when performing a scan.
- D. **Quick Slope:** Measure the slope at a single wavelength.
  - o If the extinction coefficient is known, the system can calculate the concentration of the sample.
  - o For Beams users, the wavelength cannot be changed in the software.
- E. **Quick Scan:** Measure the slope over a wavelength region.
  - o For Beams users, Quick Scan is not available.
- F. **Quick Read:** Take a single absorbance reading at a specific wavelength or wavelengths.
  - o For Beams users, the wavelength field is not editable and the multi-wavelength option is not available.

Figure 8. Instrument Controls



### Instrument Controls

Instrument controls can be found in the upper-right corner of the application. The following indicators and functions are displayed in Figure 8:

- A. **VIPER Status:** Displays the status of the system.
- B. **Instrument Status:** Displays the VPT device that is currently connected.
- C. **Home Button:** Click to send the device to the Home Position (maximum pathlength).
- D. **Load/Unload Button (FlowVPX only):** Click to launch instructions to either load or unload a Flow Cell.

### Your Quick View

Your Quick View can be found on the right panel of every application and provides a snapshot of the data collected. The window can be expanded by clicking the double arrow icon. The data displayed can be customized by clicking on the ellipsis (...) in Your Quick View header bar. The following fields can be displayed:

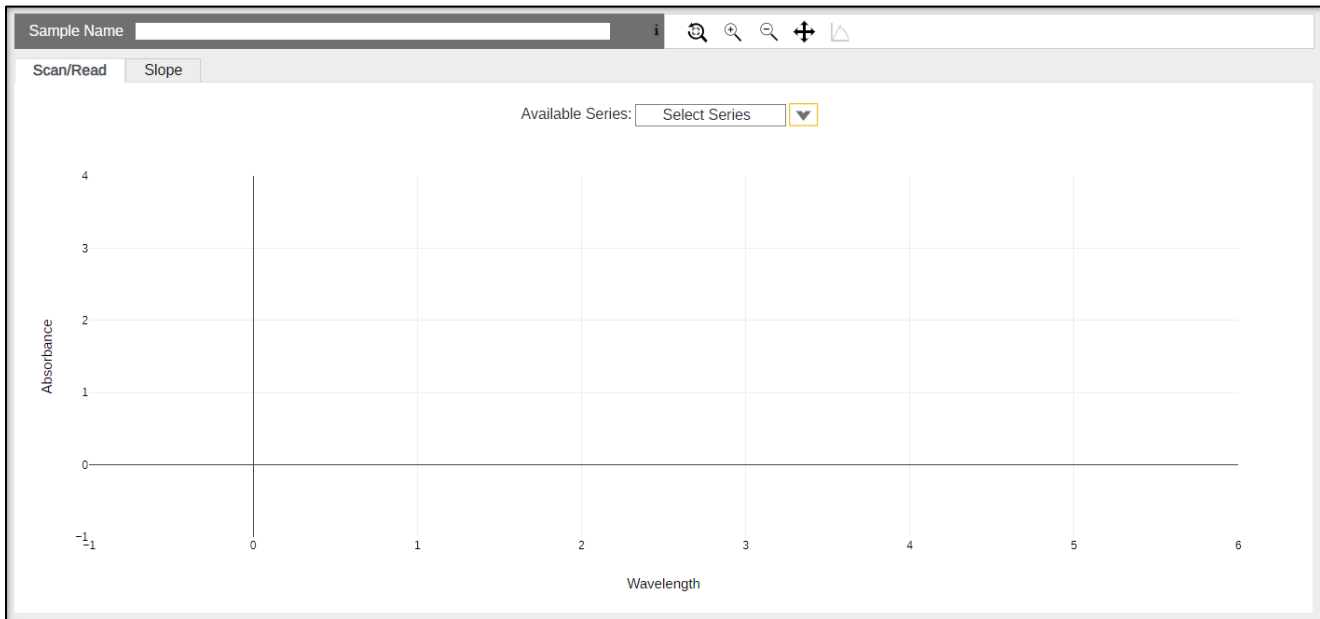
- Absorbance or %Transmission (changes based on the Y Mode selected in the method input menu)
- Wavelength
- Pathlength

## Graph Viewer and Tools

The graph displays data that has been collected in the most recent run. The user can toggle between viewing options:

- **Scan/Read:** Results from Quick Scan and Quick Read (Absorbance vs. Wavelength data) will be displayed here.
- **Slope:** Results from Quick Slope (Absorbance vs. Pathlength data) will be displayed here.

Figure 9. Manual Controls Graph Viewer



The tools above the graph can be used to zoom in and out. Click and drag in the graph area to zoom in on a specific region of the graph. After selecting the Pan tool, click and drag to move the region shown. The Peak Finder allows the user to search for the peak absorbance values within a completed Quick Scan.

## Report Viewer

Results are displayed here. View options vary based on whether the Graph Viewer is set to Scan/Read or Slope.

### Graph Viewer set to Scan/Read:

- **Scan/Read Reporter:** Displays the results from Quick Scan and Quick Read.
- **Raw Data:** Displays the collection of discrete absorbance measurements at corresponding pathlength values and the time each data point was acquired.

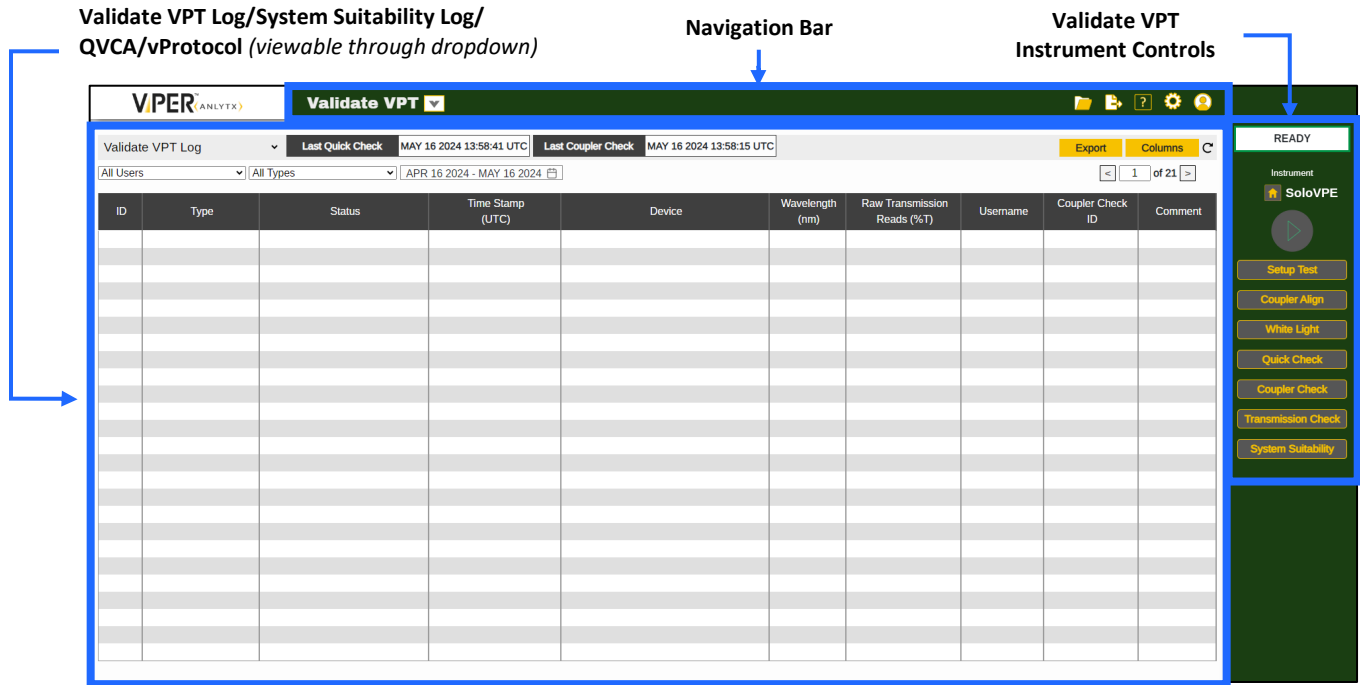
### Graph Viewer set to Slope:

- **Slope Reporter:** Displays instrument information, method parameters, and other details about the Quick Slope run.
- **Slope Data:** Displays the results from Quick Slope.
- **Raw Data:** Displays the collection of discrete absorbance measurements at corresponding pathlength values and the time each data point was acquired.

## 3.2 Validate VPT

The Validate VPT is compatible with both the SoloVPE and FlowVPX Systems. This application allows users to verify system health and performance, ensuring accuracy and reliability of the variable pathlength hardware. The application includes Quick Check, Coupler Check, and System Suitability Tests.

Figure 10. Validate VPT application: menus and sections.



**Navigation Bar**

The navigation bar can be found at the top of the application and contains the following actions:

Table 3. Validate VPT Navigation Bar Icons

Symbol	Name	Description
	Available Apps	Click to change to another application.
	Open	Opens a data table with all previously saved reports. Select an item and click Open to view the report. The user can search by sample name or filter by user and date.
	Export	Exports the last opened report as a PDF. The report can also be printed.
	Help	Opens the user guide.
	Settings	Opens the Audit Log.
	User Options	Click to log out of VIPER.

**Validate VPT Log**

This log displays Quick Check, Coupler Check, and Transmission Check tests that have been performed, including the date when each test was last completed. The table columns are sortable and customizable, and the log can be filtered by username, reference type, and date. The user may export the log as either an .xlsx (Excel) or .csv file.

Figure 11. Example Validate VPT Log

Validate VPT Log											
		Last Quick Check		APR 18 2024 13:31:26 UTC		Last Coupler Check				Export Columns	
All Users		All Types		APR 01 2018 - MAY 30 2024						1 of 1	
ID	Type	Status	Time Stamp (UTC)	Device	Wavelength (nm)	Raw Transmission Reads (%T)	Coupler Check ID	Username	Comment	eSigner	
8	Quick Check	93.60869%	APR 18 2024 13:31:26	SoloVPE (CTMCK1712345)	250.00	93.60869	5	admin	N/A	admin (Author)	
8	Quick Check	Invalid: 120.57162%	APR 18 2024 13:31:26	SoloVPE (CTMCK1712345)	500.00	98.26931	5	admin	N/A	admin (Author)	
5	Coupler Check	81.50285%T	APR 18 2024 13:23:26	SoloVPE (CTMCK1712345)	500.00	81.50285	N/A	admin	N/A	N/A	
4	Quick Check	93.60869%	APR 18 2024 13:20:07	SoloVPE (CTMCK1712345)	250.00	93.60869	3	admin	N/A	User One (Reviewer)	
4	Quick Check	Invalid: 120.57162%	APR 18 2024 13:20:07	SoloVPE (CTMCK1712345)	500.00	98.26931	3	admin	N/A	User One (Reviewer)	
4	Quick Check	93.60869%	APR 18 2024 13:20:07	SoloVPE (CTMCK1712345)	250.00	93.60869	3	admin	N/A	admin (Author)	
4	Quick Check	Invalid: 120.57162%	APR 18 2024 13:20:07	SoloVPE (CTMCK1712345)	500.00	98.26931	3	admin	N/A	admin (Author)	
3	Coupler Check	81.50285%T	APR 18 2024 13:19:49	SoloVPE (CTMCK1712345)	500.00	81.50285	N/A	admin	comment	N/A	

### System Suitability Log

This log displays System Suitability Tests that have been performed. The table columns are sortable, and the log can be filtered by username, reference material type, and date. The user may export the log as either an .xlsx (Excel) or .csv file.

Figure 12. Example System Suitability Log

System Suitability Log											
		Last Quick Check		APR 18 2024 13:31:26 UTC		Last Coupler Check				Export Columns	
All Users		All References		APR 30 2024 - MAY 30 2024						1 of 1	
ID	DAQ ID	Username	Reference Type	Reference Identifier	Expected Value	Variance	%RSD	Acquired Value	Result	Time Stamp (UTC)	eSigner
23	12	admin	CHEM013	6456168461	Slope @ 280.00: 0.0802	± 5.00000%	0.00	0.07826	Passed	MAY 02 2024 21:14:23	N/A
21	12	admin	CHEM013	6456168461	Slope @ 280.00: 0.0802	± 5.00000%	0.00	0.07826	Passed	MAY 02 2024 21:14:23	N/A
19	12	admin	CHEM013	6456168461	Slope @ 280.00: 0.0802	± 5.00000%	0.00	0.07826	Passed	MAY 02 2024 21:14:23	N/A
24	12	admin	CHEM013	6456168461	Slope @ 256.00: 0.04935	± 5.00000%	0.00	0.04732	Passed	MAY 02 2024 21:14:23	N/A
22	12	admin	CHEM013	6456168461	Slope @ 256.00: 0.04935	± 5.00000%	0.00	0.04732	Passed	MAY 02 2024 21:14:23	N/A
20	12	admin	CHEM013	6456168461	Slope @ 256.00: 0.04935	± 5.00000%	0.00	0.04732	Passed	MAY 02 2024 21:14:23	N/A
17	11	admin	CHEM013	45345234	Slope @ 280.00: 0.79	± 5.00000%	0.00	0.07826	Failed	MAY 02 2024 21:01:15	N/A
15	11	admin	CHEM013	45345234	Slope @ 280.00: 0.79	± 5.00000%	0.00	0.07826	Failed	MAY 02 2024 21:01:15	N/A
13	11	admin	CHEM013	45345234	Slope @ 280.00: 0.79	± 5.00000%	0.00	0.07826	Failed	MAY 02 2024 21:01:15	N/A
18	11	admin	CHEM013	45345234	Slope @ 256.00: 0.098	± 5.00000%	0.00	0.04732	Failed	MAY 02 2024 21:01:15	N/A
16	11	admin	CHEM013	45345234	Slope @ 256.00: 0.098	± 5.00000%	0.00	0.04732	Failed	MAY 02 2024 21:01:15	N/A
14	11	admin	CHEM013	45345234	Slope @ 256.00: 0.098	± 5.00000%	0.00	0.04732	Failed	MAY 02 2024 21:01:15	N/A

### QVCA

The QuickVCA (QVCA) feature allows users to run a variety of instrument- and pharmacopoeia-specific validation tests on the VPT system and Cary 60 light source. These tests require the Validation Cuvette Adapter, which accepts standard 10 mm cuvettes.

The tests can be configured by clicking the Setup Test button in the Instrument Controls panel.

### vProtocol

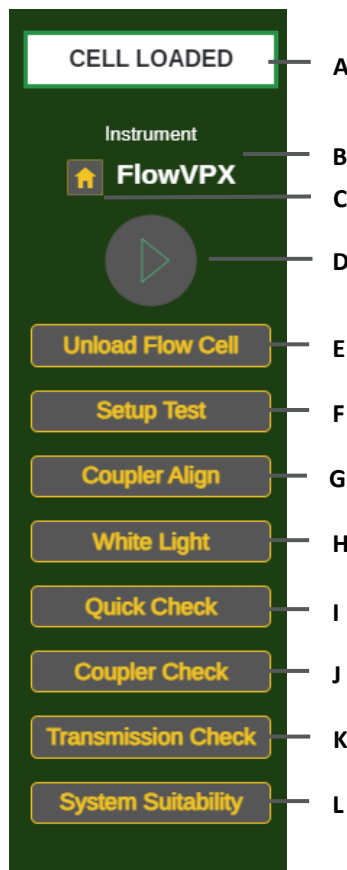
The vProtocol log displays IQOQ and PM(OQ) services that have been performed on the system. Items with a “Finished” status can be reviewed by clicking on the word Finished. The table columns are sortable. The log can be exported as a PDF.



Figure 13. Example vProtocol Log

vProtocol		Last Quick Check	APR 10 2024 18:19:00 UTC	Last Coupler Check	APR 10 2024 18:12:22 UTC		
ID	Type	Status	Service Date (UTC)	Serial Number	Serviced By	Comment	
3803	Preventative Maintenance	Paused	MAR 21 2024 15:33:25		John Smith	N/A	
3777	IQOQ CPV	Finished	MAR 14 2024 15:00:04		John Smith	Installation qualification	
3776	IQOQ CPV	Paused	MAR 14 2024 14:57:20		John Smith	N/A	
3775	IQOQ CPV	Paused	MAR 14 2024 14:54:18		John Smith	N/A	
3774	IQOQ CPV	Finished	MAR 14 2024 14:50:06		John Smith	Installation qualification	
3773	IQOQ CPV	Paused	MAR 11 2024 14:55:43		John Smith	N/A	
3772	IQOQ CPV	Paused	MAR 11 2024 14:54:21		John Smith	N/A	
3640	IQOQ	Finished	JAN 11 2024 20:34:10		John Smith	Test	
3639	IQOQ	Paused	JAN 11 2024 20:32:57		John Smith	N/A	
3638	IQOQ	Paused	JAN 11 2024 20:25:03		John Smith	N/A	

Figure 14. Validate VPT Instrument Controls



### Instrument Controls

Instrument controls can be found in the upper right corner of the application. The following indicators and functions are displayed in **Error! Reference source not found.**:

- A. **ViPER Status:** Displays the status of the system.
- B. **Instrument Status:** Displays the VPT device currently connected.
- C. **Home Button:** Click to send the device to the Home Position (maximum pathlength).
- D. **Collect Button:** Click to initiate data collection using the current method parameters.
- E. **Load/Unload Flow Cell (FlowVPX only):** Click to launch instructions to either load or unload a Flow Cell.
- F. **Setup Test:** Configure QuickVCA tests.
- G. **Coupler Align:** Facilitates adjustments to maximize transmission through the Fiber Optic Coupler.
- H. **White Light:** Set the Cary 60 to emit white light (full spectrum) rather than a single wavelength. Also called Zero Order.
- I. **Quick Check Button:** Begin a Quick Check test.
- J. **Coupler Check Button:** Begin a Coupler Check test.
- K. **Transmission Check (FlowVPX only):** Begin a Transmission Check test.
- L. **System Suitability Button:** Begin a System Suitability Test.

### Coupler Check (SoloVPE/FlowVPX with Cary 60 only)

The Coupler Check will verify that enough light is being transmitted from the Cary 60 light source through the Dual-Use Fiber Optic Coupler to the VPT instrument. This test is conducted using 500 nm light. It is recommended to perform a Coupler Check once every month. The Validate VPT application displays the date of the last Coupler Check and indicates “OVERDUE” if the test has not been performed for over one month.

See section 4.3.1 for steps to perform a Coupler Check.

### Transmission Check (FlowVPX with Cary 60 only)

The Transmission Check will verify that enough light is being transmitted from the Cary 60 light source through the Dual-Use Fiber Optic Coupler to the FlowVPX instrument. The user may select the wavelength of light used for this test. The Validate VPT application displays the date of the last Transmission Check.

See section 4.4.1 for steps to perform a Transmission Check.

### Quick Check

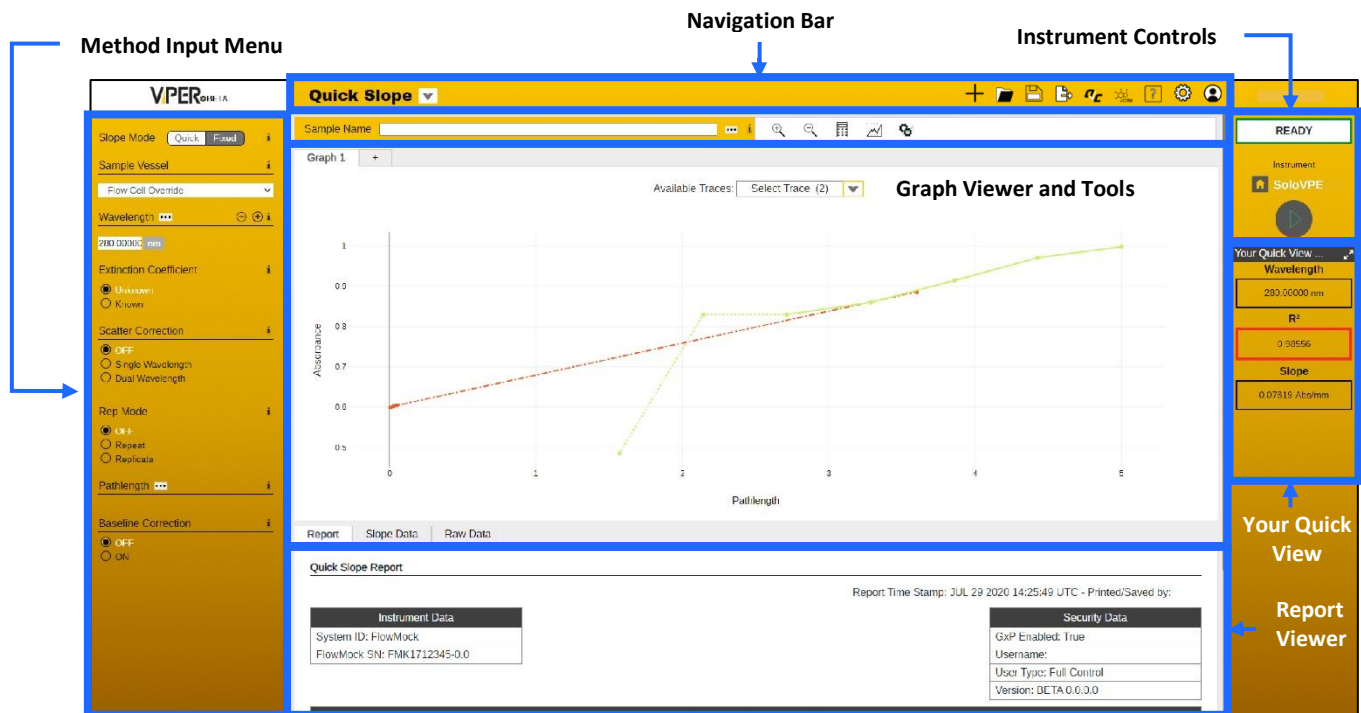
The Quick Check verifies adequate transmission through the Fibrette® Optical Component of the VPT instrument. The Quick Check result is displayed as a percentage relative to the Coupler Check or Beams Source internal reference measurement. It is recommended to perform a Quick Check each day of operation.

For steps to perform a Quick Check, see section 4.3.2 (SoloVPE System with Cary 60), section 4.4.3 (FlowVPX System with Cary 60), or section 4.5.1 (FlowVPX System with Beams).

### 3.3 Quick Slope

The Quick Slope application is compatible with the SoloVPE System. This application measures sample absorbance versus pathlength to obtain a slope. If the extinction coefficient is known, the system calculates the sample concentration. The reporting feature allows the user to export data in a variety of formats.

Figure 15. Quick Slope application: menus and sections.



### Navigation Bar

The navigation bar can be found at the top of the application and contains the following actions:

Table 4. Quick Slope Navigation Bar Icons











Symbol	Name	Options	Description
	Available Apps	—	Click to change to another application.
	Reset	Reset Run	Clears the data collected but does not modify the Method Input menu.
		Reset Method	Resets the method to the admin-configured default settings but does not clear the data.
		Reset All	Clears the data and resets method to the admin-configured default settings.
	Open	Open Method	Opens a data table with all previously saved methods organized by name, date saved, user, and application. Users can search by method name and filter by user and application.
		Open Data	Opens a data table with all previously collected data organized by sample name, date saved, and the user who collected the data. Users can search by DAQ ID, method name, and date saved; users can also filter by user and date. All data collected is autosaved by sample name.
		Open Report	Opens a data table with previously saved reports organized by name of report, date saved, and the user who created the report.
	Save	Save Method	Saves method to the database.
		Save Report	Saves report to the database.
	Export	Export Method	Exports the configured method as a .ctm file. The file is saved to the default downloads location as determined by the user's Chrome settings.
		Export Data	Exports the data collected as either an .xlsx (Excel) or .csv file. The file is saved to the default downloads location as determined by the user's Chrome settings.
		Export Report	Exports the report as a .pdf file. The file is saved to the default downloads location as determined by the user's Chrome settings.
	Quick Check	—	Opens the Validate VPT log, showing recent performance tests. The user can click on any test from the log and add it to the current report. The user can also initiate a Quick Check and/or Coupler Check by clicking the buttons in the right panel.
	System Suitability	—	Assesses VPT system health using ConfIRM® Slope Reference Materials, CHEM013 Measurement Standard, or other reference standard.
	Help	—	Opens the user guide.
	Settings	Method Detail	Displays parameters of the last method run.
		Audit Log	Opens the Audit Log.
	User Options	—	Click to log out of VIPER.

Figure 16. Quick Slope Method Input Menu

The screenshot shows the 'Quick Slope Method Input Menu' with the following settings and callouts:

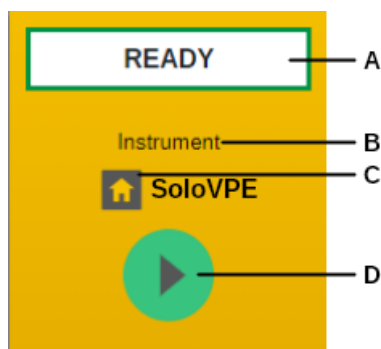
- A:** Slope Mode: Quick (selected), Fixed
- B:** Sample Vessel: Select Sample Vessel (dropdown)
- C:** Wavelength: 280.00 nm (input field with ellipsis and plus icon)
- D:** Extinction Coefficient: Unknown (selected), Known
- E:** Scatter Correction: Off (dropdown)
- F:** Rep Mode: OFF (selected), Repeat, Replicate
- G:** A black bar at the bottom of the menu.
- H:** Pathlength: (input field with ellipsis)
- I:** Baseline Correction: OFF (selected), ON

## Method Input Menu

The method input menu is the left panel in the application workspace. This menu allows the user to configure parameters for method creation and data collection. The following functions are displayed in **Error! Reference source not found.**:

- A. **Slope Mode:** Set the VPT device to Quick or Fixed mode. This option affects the parameters displayed under Pathlength (see item H below for details).
- B. **Sample Vessel:** Select the size of the sample vessel or Flow Cell that will be loaded into the instrument.
- C. **Wavelength:** Enter a range from 190 nm to 1100 nm.
  - To measure at multiple wavelengths, click (+) to add another wavelength. Not available for Beams users.
  - Click the ellipsis (...) to change the averaging time.
- D. **Extinction Coefficient:** If known, the system can calculate the concentration of the sample.
  - If multiple wavelengths are entered, the user can enter an extinction coefficient for each wavelength.
- E. **Scatter Correction:** Enable or disable an algorithm that subtracts the absorbance contribution due to molecular interactions with the incident light or particle dispersion. See section 4.2 for details.
- F. **Rep Mode:** Enable to collect multiple slope measurements.
  - **Repeat:** The instrument repeats the search algorithm and data collection without changing the Fibrette or sample vessel.
  - **Replicate:** The instrument returns to the Home Position between measurements, allowing the user to change the Fibrette and sample vessel. Each replicate measurement consists of both the search algorithm and data collection.
- G. **Minimize Menu:** Click the black bar to hide the Method Input Menu.
- H. **Pathlength:** This parameter appears differently depending on the Slope Mode (item A above) selected.
  - In **Quick Mode**, the user can set the target absorbance, search pathlengths, and number of data points. The system will find the target absorbance by making successive measurements at the search pathlengths, then collect the specified number of data points by incrementally decreasing the pathlength.
  - In **Fixed Mode**, the user can set the starting pathlength, step size, and number of data points. The system will measure the absorbance beginning at the starting pathlength and then collect data at each step (decreasing the pathlength) until it reaches the specified number of data points.
- I. **Baseline Correction:** Enable or disable an algorithm that subtracts the absorbance contribution due to the buffer. When enabled, a baseline measurement must be collected before the run can begin.

Figure 17. Quick Slope Instrument Controls



### Instrument Controls

Instrument controls can be found in the upper right corner of the application. The following indicators and functions are displayed in **Error! Reference source not found.**:

- A. **ViPER Status:** Displays the status of the system.
- B. **Instrument Status:** Displays the VPT device currently connected.
- C. **Home Button:** Click to send the device to the Home Position (maximum pathlength).
- D. **Collect Button:** Click to initiate data collection using the current method parameters.
  - The Baseline button appears instead of the Collect button when Baseline Correction is turned on. After performing baseline correction, the Collect button appears.

### Your Quick View

Your Quick View can be found on the right panel of every application and provides a snapshot of the data collected. The window can be expanded by clicking the double arrow icon. Fields can be shown or hidden by clicking the ellipsis (...) in the Quick View header bar. The following fields can be displayed:

- Concentration
- Wavelength
- R<sup>2</sup>
- Slope
- Baseline
- User Result

### Sample Details

The sample name must be entered in the field below the navigation bar before beginning data collection. Click the ellipsis (...) next to the text box to enter additional information about the sample.

Figure 18. Quick Slope Sample Name Field



### Graph Viewer and Tools

The graph viewer displays all data collected.

- Click the “+” tab at the top of the graph area to open a blank graph for new data to be collected and plotted.
- Navigate between data plots by clicking the Graph 1, Graph 2, etc. tabs.
- Select a trace from the drop-down menu above the graph to hide all data except the selected trace.
- Click and drag within the graph area to zoom in on a specific region of the graph.

The viewing tools above the graph are explained in **Error! Reference source not found.**.

Figure 19. Quick Slope Graph Viewer

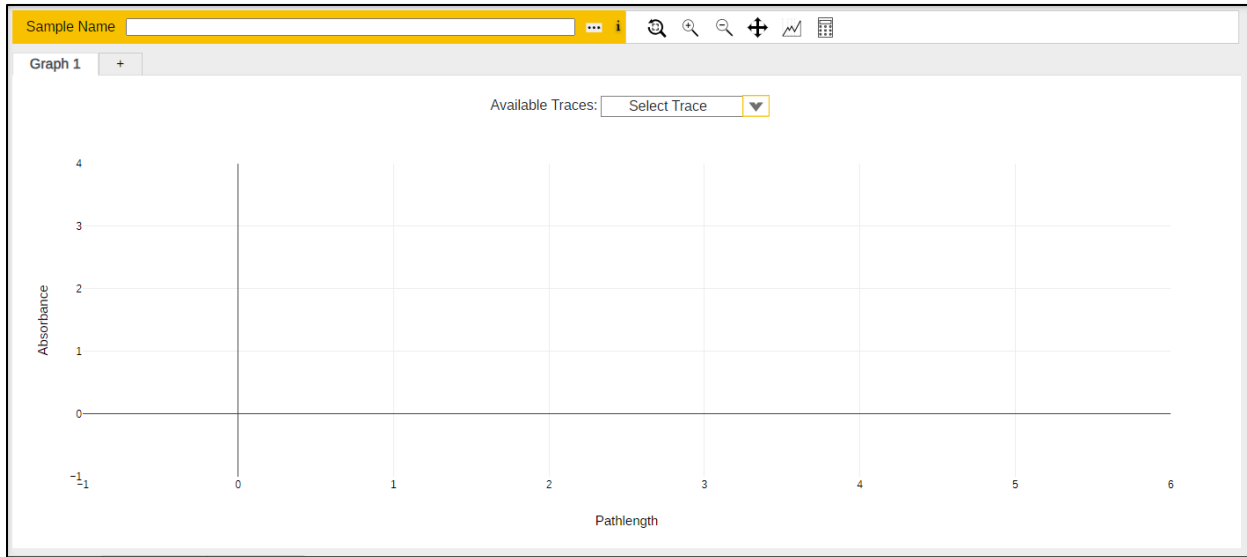


Table 5. Quick Slope Graphing Tools

Icon	Label	Description
	Zoom Reset	Resets the graph to the default view.
	Zoom In	Zooms in.
	Zoom Out	Zooms out.
	Pan	Allows the user to click and drag to pan across the graph area.
	Slope Analysis Tool	Allows the user to further analyze section data by adjusting parameters such as the pathlength range and extinction coefficient.
	Calculator	Allows the user to define custom calculations. Calculations must be defined prior to starting data acquisition. Upon completing the method, the results of user-defined calculations are shown in Your Quick View and added to the report.

### Report Viewer

Results are displayed here. There are three reporting tabs:

- **Reporter:** Displays all data collected, in addition to information about the VPT device, method, and security.
- **Slope Data:** Displays the results calculated from the data collected, including slope,  $R^2$ , wavelength, extinction coefficient (if known), and user-defined results.
- **Raw Data:** Displays the collection of discrete absorbance measurements at corresponding pathlengths and wavelengths.



Performance test results that have been recorded in the Validate VPT Log can be added to the report by clicking on the Quick Check icon (pictured left) in the navigation bar. Select Validate VPT or System Suitability from the drop-down menu, then click on any test result to add it to the report.

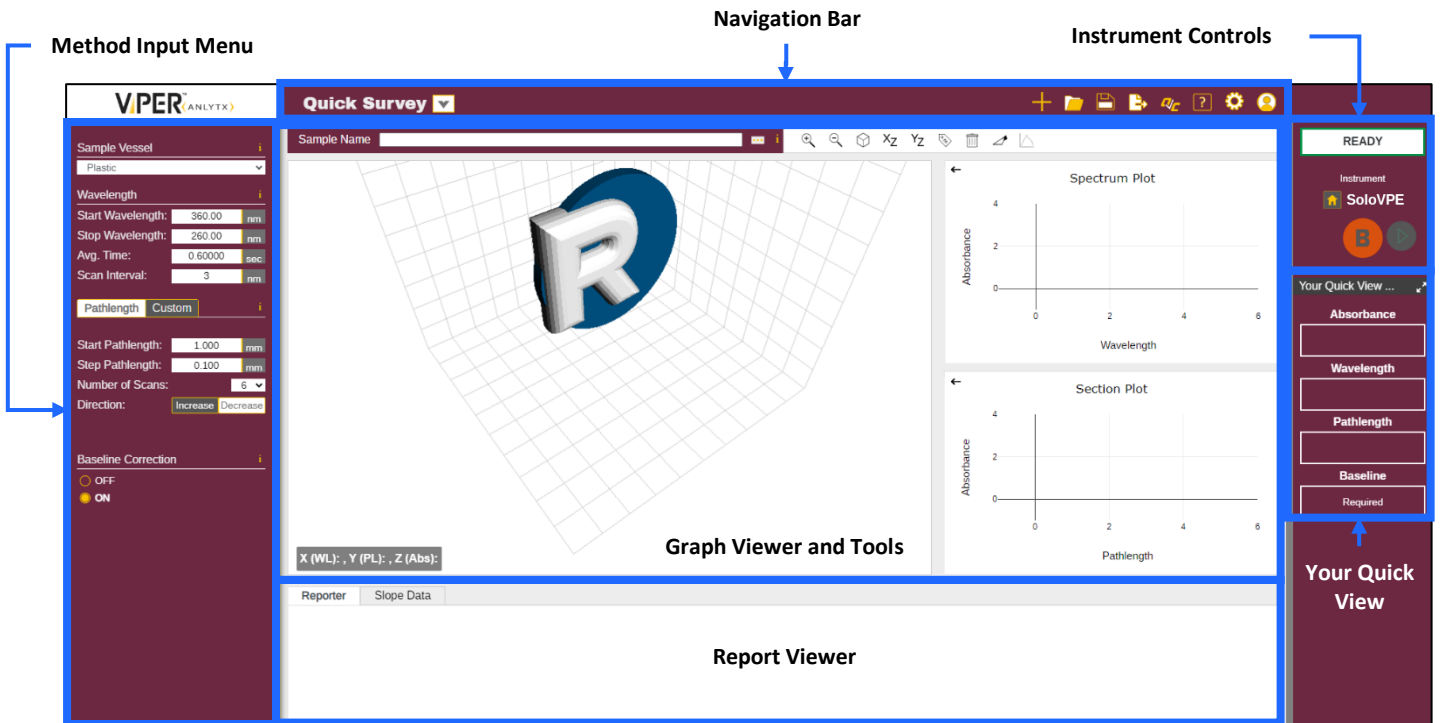
Once data has been collected, the user can access the Report Wizard to configure the report; see section 4.1 for details.

### 3.4 Quick Survey

The Quick Survey application is compatible with the SoloVPE System. This application characterizes samples as three-dimensional surfaces based on Absorbance vs. Pathlength and Absorbance vs. Wavelength data. The system collects multiple spectral readings at multiple pathlengths to quickly determine the wavelengths of interest (absorbance peaks) and required pathlength ranges to measure those peaks.

The user can view the two-dimensional Spectrum plot (Absorbance vs. Wavelength) and Section Plot (Absorbance vs. Pathlength) in addition to the three-dimensional surface plot. All graphs are interactive.

Figure 20. Quick Survey application: menus and sections.



#### Navigation Bar

The navigation bar can be found at the top of the application and contains the following actions:

Table 6. Quick Survey Navigation Bar Icons

Symbol	Name	Options	Description
	Available Apps	—	Click to change to another application.
	Reset	Reset Run	Clears the data collected but does not modify the Method Input menu.
		Reset Method	Resets the method to the admin-configured default settings but does not clear the data.
		Reset All	Clears the data and resets the method to the admin-configured default settings.
	Open	Open Method	Opens a data table with all previously saved methods organized by name, date saved, user, and application. Users can search by method name and filter by user and application.
		Open Data	Opens a data table with all previously collected data organized by sample name, date saved, and the user who collected the data. Users can search by DAQ ID, method name, and date saved; users can also filter by user and date. All data collected is autosaved by sample name.







		Open Report	Opens a data table with previously saved reports organized by name of report, date saved, and the user who created the report.
	<b>Save</b>	Save Method	Saves method to the database.
		Save Report	Saves report to the database.
	<b>Export</b>	Export Method	Exports the configured method as a .ctm file. The file is saved to the default downloads location as determined by the user's Chrome settings.
		Export Data	Exports the data collected as either an .xlsx (Excel) or .csv file. The file is saved to the default downloads location as determined by the user's Chrome settings.
		Export Report	Exports the report as a .pdf file. The file is saved to the default downloads location as determined by the user's Chrome settings.
	<b>Quick Check</b>	—	Opens the Validate VPT log, showing recent performance tests. The user can click on any test from the log and add it to the current report. The user can also initiate a Quick Check and/or Coupler Check by clicking the buttons in the right panel.
	<b>Help</b>	—	Opens the user guide.
	<b>Settings</b>	Method Detail	Displays parameters of the last method run.
		Audit Log	Opens the Audit Log.
	<b>User Options</b>	—	Click to log out of VIPER.

Figure 21. Quick Survey Method Input Menu

### Method Input Menu

The method input menu is the left panel in the application workspace. This menu allows the user to configure parameters for method creation and data collection. The following functions are displayed in Figure 21:

- A. **Sample Vessel:** Select the size of the vessel that will be loaded into the instrument.
- B. **Wavelength:** Choose the wavelength range of the scan, averaging time, and wavelength step size.
- C. **Pathlength:** Choose the pathlength settings for the scan.
  - **Pathlength:** User can set the starting pathlength, step size, number of steps, and direction (increase/decrease).
  - **Custom:** User can enter as many specific pathlengths as desired. Click (+) to add more or (-) to remove the last pathlength from the list. The user can select the direction (increase/decrease).
- D. **Minimize Menu:** Click the yellow bar to hide the method input menu.
- E. **Baseline Correction:** Enable or disable an algorithm that subtracts the absorbance contribution due to the buffer. When enabled, a baseline measurement must be collected before the run can begin.

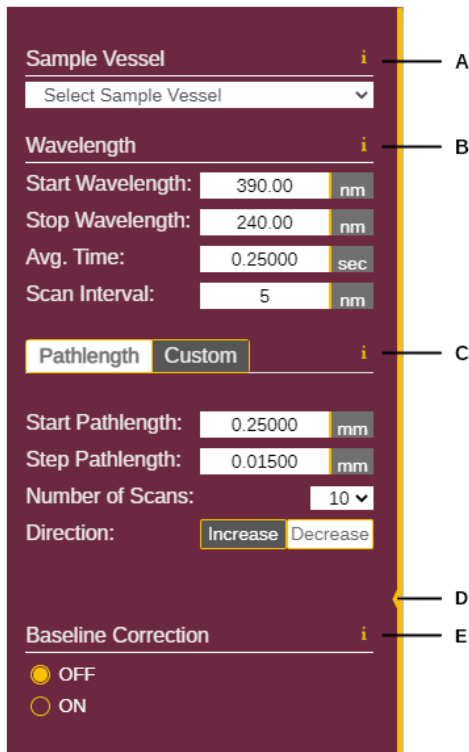
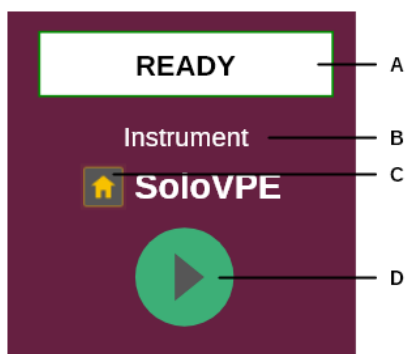




Figure 22. Quick Survey Instrument Controls



### Instrument Controls

Instrument controls can be found in the upper-right corner of the application. The following indicators and functions are displayed in Figure 22:

- A. **ViPER Status:** Displays the status of the system.
- B. **Instrument Status:** Displays the VPT device currently connected.
- C. **Home Button:** Click to send the device to the Home Position (maximum pathlength).
- D. **Collect Button:** Click to initiate data collection using the current method parameters.
  - The Baseline button appears instead of the Collect button when Baseline Correction is turned on. After performing baseline correction, the Collect button appears.

### Your Quick View

Your Quick View can be found on the right panel of every application and provides a snapshot of the data collected. The window can be expanded by clicking the double arrow icon. The data displayed can be customized by clicking on the ellipsis (...). The following fields can be displayed:

- Absorbance
- Wavelength
- Pathlength

### Sample Details

The sample name must be entered in the field below the navigation bar before beginning data collection. Click the ellipsis (...) next to the text box to enter additional information about the sample.

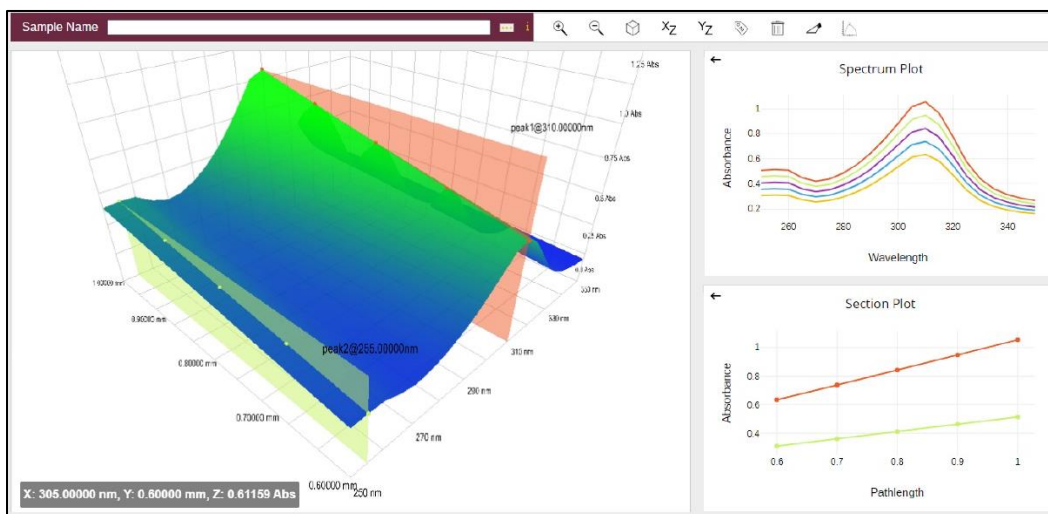
Figure 23. Quick Survey Sample Name Field



### Graph Viewer and Tools

The graph viewer displays the data collected in 3 graphs. The three-dimensional graph displays absorbance (z-axis) vs. wavelength (x-axis) and pathlength (y-axis). The Spectrum plot displays absorbance (y) vs. wavelength (x). The Section plot displays absorbance (y) vs. pathlength (x).

Figure 24. Quick Survey Graph Viewer



All graphs are interactive by clicking and dragging in the graph area. The tools above the graph affect the view of the graph currently occupying the largest of the three windows. Click the arrow in the upper left corner of either smaller graph to move that graph to the large window.

Table 7. Quick Survey Graphing Tools

Icon	Label	Description
	Zoom In	Zooms in.
	Zoom Out	Zooms out.
	Isometric View	Set the view to show all three axes equally.
	XZ View	Set the view to focus on absorbance versus wavelength.
	YZ View	Set the view to focus on absorbance versus pathlength.
	Add Annotations	Hold CTRL and click to apply a pin to a data point on the graph.
	Clear Annotations	Remove all annotations.
	Slice Tool	Hold CTRL and click to apply a slice, which will be displayed in the Section Plot.
	Peak Finder	Scans the spectrum over the wavelength range of the data to find peak absorbance values.

### Report Viewer

Results are displayed here. There are two reporting tabs:

- **Reporter:** Displays all data collected, in addition to information about the instrument, method configurations, run details, and security.
- **Slope Data:** Displays the slope,  $R^2$ , and wavelength of data selected using the Slice Tool.



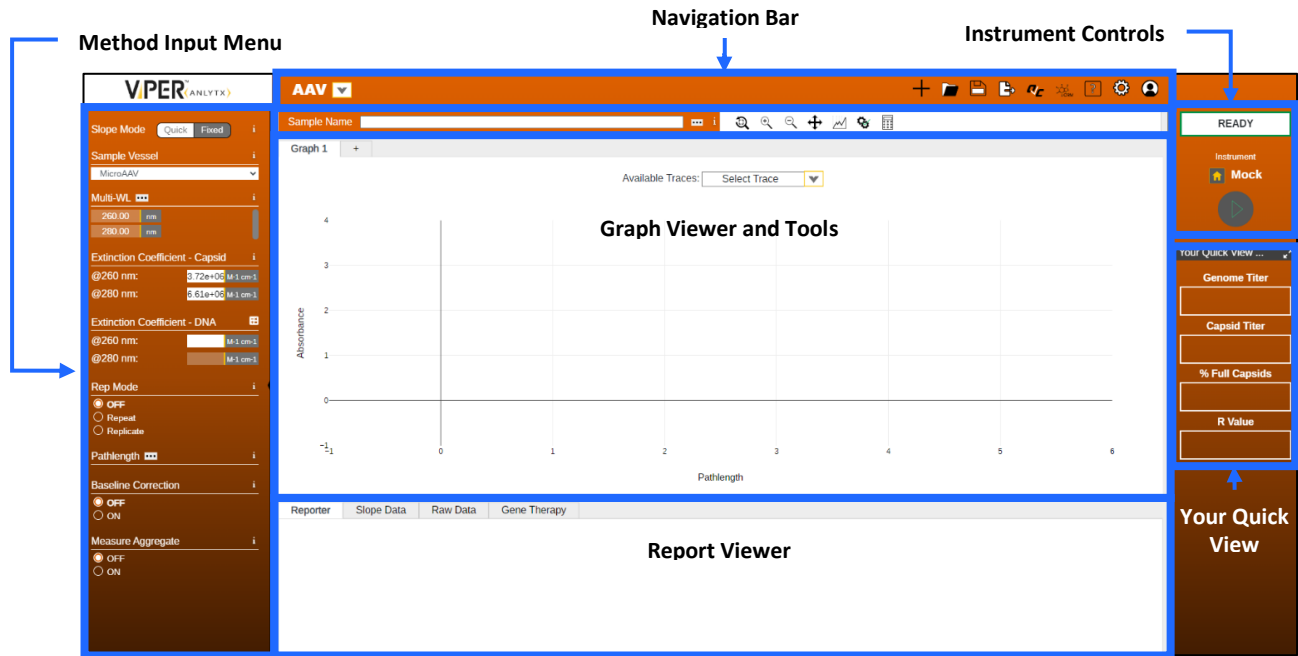
Performance test results that have been recorded in the Validate VPT Log can be added to the report by clicking on the Quick Check icon (pictured left) in the navigation bar. Select Validate VPT or System Suitability from the drop-down menu, then click on any test result entry to add it to the report.

Once data has been collected, the user can access the Report Wizard to configure the report; see section 4.1 for details.

### 3.5 AAV (Adeno-Associated Virus)

The AAV application is compatible with the SoloVPE System. This application automates testing of adeno-associated virus samples to determine genome and capsid titer and the percentage of full capsids or full-to-empty ratios. Results are generated in units of vector genome per milliliter (vg/ml) and capsid particles per milliliter (cp/ml).

Figure 25. AAV application: menus and sections.









#### Navigation Bar

The navigation bar can be found at the top of the application and contains the following actions:

Table 8. AAV Navigation Bar Icons

Symbol	Name	Options	Description
	Available Apps	—	Click to change to another application.
	Reset	Reset Run	Clears the data collected but does not modify the Method Input menu.
		Reset Method	Resets the method to the admin-configured default settings but does not clear the data.
		Reset All	Clears the data and resets method to the admin-configured default settings.
	Open	Open Method	Opens a data table with all previously saved methods organized by name, date saved, user, and application. Users can search by method name and filter by user and application.
		Open Data	Opens a data table with all previously collected data organized by sample name, date saved, and the user who collected the data. Users can search by DAQ ID, method name, and date saved; users can also filter by user and date. All data collected is autosaved by sample name.
		Open Report	Opens a data table with previously saved reports organized by name of report, date saved, and the user who created the report.
	Save	Save Method	Saves method to the database.
		Save Report	Saves report to the database.

	<b>Export</b>	Export Method	Exports the configured method as a .ctm file. The file is saved to the default downloads location as determined by the user's Chrome settings.
		Export Data	Exports the data collected as either an .xlsx (Excel) or .csv file. The file is saved to the default downloads location as determined by the user's Chrome settings.
		Export Report	Exports the report as a .pdf file. The file is saved to the default downloads location as determined by the user's Chrome settings.
	<b>Quick Check</b>	—	Opens the Validate VPT log, showing recent performance tests. The user can click on any test from the log and add it to the current report. The user can also initiate a Quick Check and/or Coupler Check by clicking the buttons in the right panel.
	<b>System Suitability</b>	—	Assesses VPT system health using ConfIRM Slope Reference Materials, CHEM013 Measurement Standard, or other reference standard.
	<b>Help</b>	—	Opens the user guide.
	<b>Settings</b>	Method Detail	Displays parameters of the last method run.
		Audit Log	Opens the Audit Log.
	<b>User Options</b>	—	Click to log out of ViPER.

See next page for the sections of the AAV Method Input Menu.

Figure 26. AAV Method Input Menu

The screenshot shows the AAV Method Input Menu with the following controls and callouts:

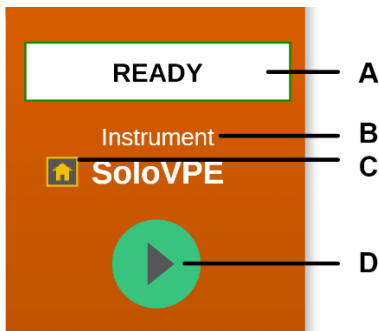
- A:** Slope Mode (Quick/Fixed buttons)
- B:** Sample Vessel (MicroAAV dropdown)
- C:** Multi-WL (260.00 nm, 280.00 nm)
- D:** Extinction Coefficient - Capsid (@260 nm: 3.72e+06 M-1 cm-1, @280 nm: 6.61e+06 M-1 cm-1)
- E:** Extinction Coefficient - DNA (@260 nm: [input], @280 nm: [input])
- F:** Rep Mode (OFF, Repeat, Replicate)
- G:** Repeat Count (3)
- H:** Pathlength (\*\*\*)
- I:** Baseline Correction (OFF/ON)
- J:** Measure Aggregate (OFF/ON)

## Method Input Menu

The method input menu is the left panel in the application workspace. This menu allows the user to configure parameters for method creation and data collection. The following functions are displayed in **Error! Reference source not found.**:

- A. **Slope Mode:** Set the VPT device to Quick or Fixed mode. This option affects the parameters displayed under Pathlength (item H below).
- B. **Sample Vessel:** Select the size of the sample vessel that will be loaded into the instrument.
- C. **Multi-WL:** The wavelength cannot be altered in the AAV application.
  - a. Click the ellipsis (...) to change the averaging time.
- D. **Extinction Coefficient – Capsid:** Enter the extinction coefficients at 260 nm and 280 nm for the capsids in the sample (if different from the default values initially shown in the fields).
- E. **Extinction Coefficient – DNA:** Enter the extinction coefficient at 260 nm for the DNA in the sample.
  - a. The extinction coefficient at 280 nm is automatically calculated based on the value entered for 260 nm.
  - b. The white button opens a DNA calculator for reference.
- F. **Rep Mode:** Enable to collect multiple slope measurements.
  - a. **Repeat:** The instrument repeats the search algorithm and data collection without changing the Fibrette or sample vessel.
  - b. **Replicate:** The instrument returns to the Home Position between measurements, allowing the user to change the Fibrette and sample vessel. Each replicate measurement consists of both the search algorithm and data collection.
- G. **Minimize Menu:** Click the black bar to hide the Method Input Menu.
- H. **Pathlength:** This parameter appears differently depending on the Slope Mode (item A above) selected.
  - a. In **Quick Mode**, the user can set the target absorbance, search pathlengths, and number of data points. The system will find the target absorbance by making successive measurements at the search pathlengths, then collect the specified number of data points by incrementally decreasing the pathlength.
  - b. In **Fixed Mode**, the user can set the starting pathlength, step size, and number of data points. The system will measure the absorbance beginning at the starting pathlength and then collect data at each step (decreasing the pathlength) until it reaches the specified number of data points.
- I. **Baseline Correction:** Enable or disable an algorithm that subtracts the absorbance contribution due to the buffer. When enabled, a baseline measurement must be collected before the run can begin.
- J. **Measure Aggregate:** Measure potential particulates or aggregates at an additional wavelength to help identify changes in the sample's stability. The wavelength can be entered under Multi-WL (item C).

Figure 27. AAV Instrument Controls



### Instrument Controls

Instrument controls can be found in the upper right corner of the application. The following indicators and functions are displayed in **Error! Reference source not found.:**

- A. **ViPER Status:** Displays the status of the system.
- B. **Instrument Status:** Displays the VPT device currently connected.
- C. **Home Button:** Click to send the device to the Home Position (maximum pathlength).
- D. **Collect Button:** Click to initiate data collection using the current method parameters.
  - The Baseline button appears instead of the Collect button when Baseline Correction is turned on. After performing baseline correction, the Collect button appears.

### Your Quick View

Your Quick View can be found on the right panel of every application and provides a snapshot of the data collected. The window can be expanded by clicking the double arrow icon. Fields can be shown or hidden by clicking the ellipsis (...) in the Quick View header bar. The following fields can be displayed:

- Genome Titer
- Capsid Titer
- % Full Capsids
- R Value
- Baseline
- User Result

### Sample Details

The sample name must be entered in the field below the navigation bar before beginning data collection. Click the ellipsis (...) next to the text box to enter additional information about the sample.

Figure 28. AAV Sample Field



### Graph Viewer and Tools

The graph viewer displays all data collected.

- Click the “+” tab at the top of the graph area to open a blank graph for new data to be collected and plotted.
- Navigate between data plots by clicking the Graph 1, Graph 2, etc. tabs.
- Select a trace from the drop-down menu above the graph to hide all data except the selected trace.
- Click and drag within the graph area to zoom in on a specific region of the graph.

The tools above the graph are explained in **Error! Reference source not found..**

Figure 29. AAV Graph Viewer

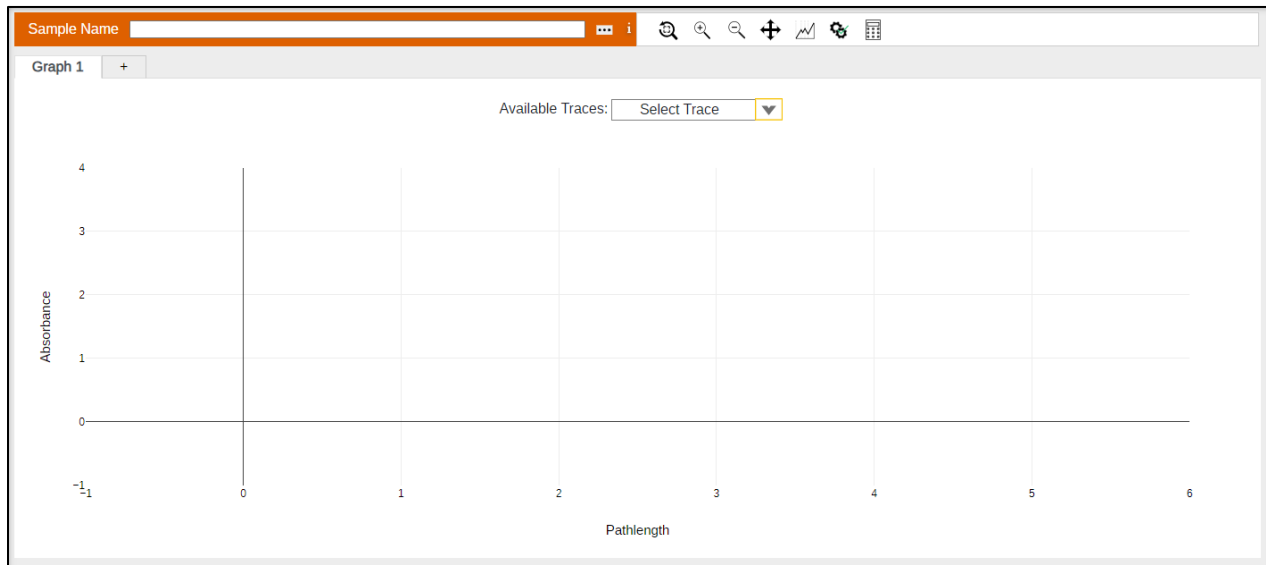


Table 9. AAV Graphing Tools

Icon	Label	Description
	Zoom Reset	Resets the graph to the default view.
	Zoom In	Zooms in.
	Zoom Out	Zooms out.
	Pan	Allows the user to click and drag to pan across the graph area.
	Slope Analysis Tool	Allows the user to further analyze section data by adjusting parameters such as the pathlength range and extinction coefficient.
	Acceptance Criteria	Allows the user to set a value for genome titer, capsid titer, and % full capsids for easy identification of acceptable results.
	Calculator	Allows the user to define custom calculations. Calculations must be defined prior to starting data acquisition. Upon completing the method, the results of user-defined calculations are shown in Your Quick View and added to the report.

### Report Viewer

Results are displayed here. There are four reporting tabs:

- **Reporter:** Displays all data collected, in addition to information about the VPT device, method, and security.
- **Slope Data:** Displays the results calculated from the data collected, including slope,  $R^2$ , wavelength, concentration, and user-defined results.
- **Raw Data:** Displays the collection of discrete absorbance measurements at corresponding pathlengths and wavelengths.
- **Gene Therapy:** Displays slope at 260 nm and 280 nm, genome and capsid titer, percentage of full capsids, and  $R$  value.



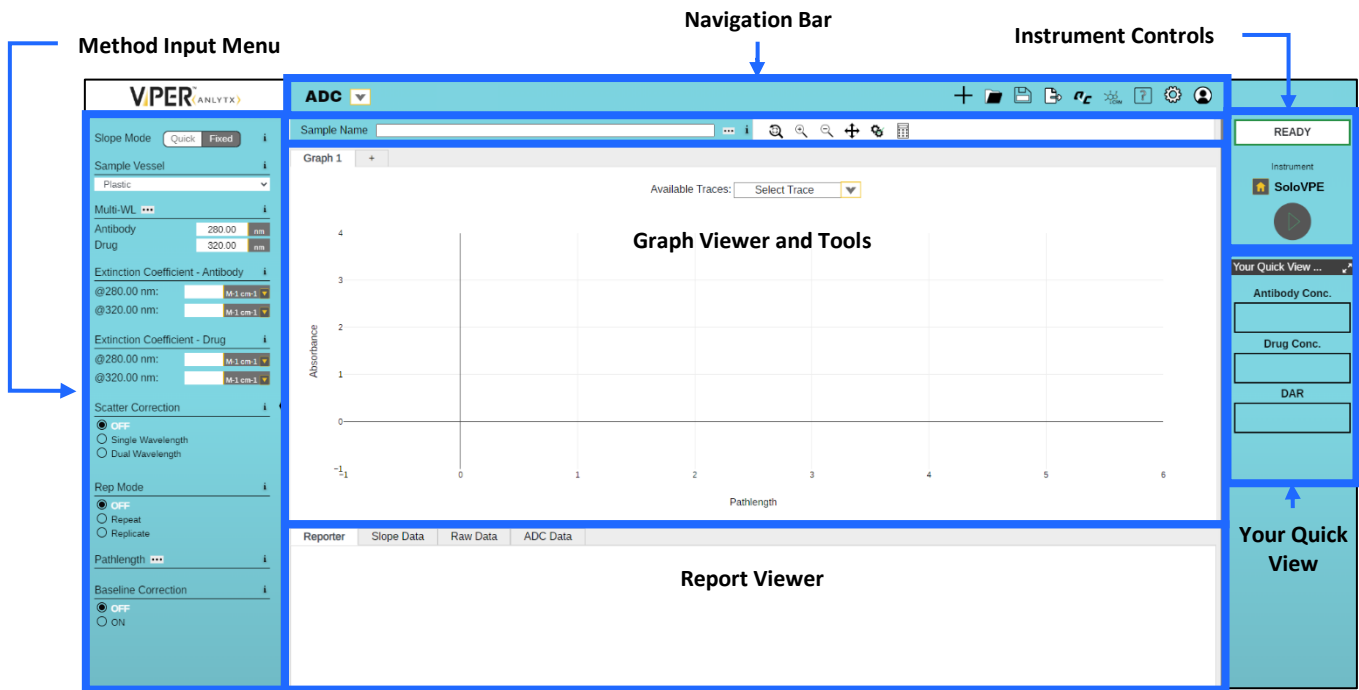
Performance test results that have been recorded in the Validate VPT Log can be added to the report by clicking on the Quick Check icon (pictured left) in the navigation bar. Select Validate VPT or System Suitability from the drop-down menu, then click on any test result to add it to the report.

Once data has been collected, the user can access the Report Wizard to configure the report; see section 4.1 for details.

### 3.6 ADC (Antibody-Drug Conjugate)

The ADC application is compatible with the SoloVPE System. This application can be used to automate tests to determine antibody concentration, drug concentration, and the drug-to-antibody ratio (DAR).

Figure 30. ADC application: menus and sections









#### Navigation Bar

The navigation bar can be found at the top of the application and contains the following actions:

Table 10. ADC Navigation Bar Icons

Icon	Label	Options	Description
	Available Apps	—	Click to change to another application.
	Reset	Reset Run	Clears the data collected but does not modify the Method Input menu.
		Reset Method	Resets the method to the admin-configured default settings but does not clear the data.
		Reset All	Clears the data and resets method to the admin-configured default settings.
	Open	Open Method	Opens a data table with all previously saved methods organized by name, date saved, user, and application. Users can search by method name and filter by user and application.
		Open Data	Opens a data table with all previously collected data organized by sample name, date saved, and the user who collected the data. Users can search by DAQ ID, method name, and date saved; users can also filter by user and date. All data collected is autosaved by sample name.
		Open Report	Opens a data table with previously saved reports organized by name of report, date saved, and the user who created the report.
	Save	Save Method	Saves method to the database.
		Save Report	Saves report to the database.



	<b>Export</b>	Export Method	Exports the configured method as a .ctm file. The file is saved to the default downloads location as determined by the user's Chrome settings.
		Export Data	Exports the data collected as either an .xlsx (Excel) or .csv file. The file is saved to the default downloads location as determined by the user's Chrome settings.
		Export Report	Exports the report as a .pdf file. The file is saved to the default downloads location as determined by the user's Chrome settings.
	<b>Quick Check</b>	—	Opens the Validate VPT log, showing recent performance tests. The user can click on any test from the log and add it to the current report. The user can also initiate a Quick Check and/or Coupler Check by clicking the buttons in the right panel.
	<b>System Suitability</b>	—	Assesses VPT system health using ConfIRM Slope Reference Materials, CHEM013 Measurement Standard, or other reference standard.
	<b>Help</b>	—	Opens the user guide.
	<b>Settings</b>	Method Detail	Displays parameters of the last method run.
		Audit Log	Opens the Audit Log.
	<b>User Options</b>	—	Click to log out of ViPER.

See next page for the sections of the ADC Method Input Menu.

Figure 31. ADC Method Input Menu

The screenshot shows the ADC Method Input Menu with the following controls and callouts:

- A:** Slope Mode (Quick/Fixed buttons)
- B:** Sample Vessel (Plastic dropdown)
- C:** Multi-WL (Multi-Wavelengths section)
- D:** Extinction Coefficient - Antibody (Input fields for 280.00 nm and 320.00 nm)
- E:** Extinction Coefficient - Drug (Input fields for 280.00 nm and 320.00 nm)
- F:** Scatter Correction (Radio buttons for OFF, Single Wavelength, Dual Wavelength)
- G:** Rep Mode (Radio buttons for OFF, Repeat, Replicate)
- H:** Pathlength (Multi-Wavelengths section)
- I:** Baseline Correction (Radio buttons for OFF, ON)
- J:** (Points to the Baseline Correction section)

## Method Input Menu

The method input menu is in the left panel in the application workspace. This menu allows the user to configure parameters for method creation and data collection.

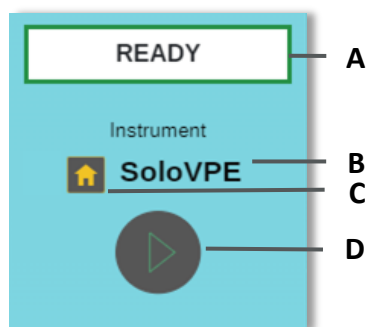
The following functions are displayed in **Error! Reference source not found.:**

- Slope Mode:** Set the VPT device to Quick or Fixed mode. This option affects the parameters displayed under Pathlength (below).
- Sample Vessel:** Select the size of the sample vessel that will be loaded into the instrument.
- Multi-WL:** Enter the target wavelength for the antibody and the drug.
  - Click the ellipsis (...) to change the averaging time.
- Extinction Coefficient - Antibody:** Enter the extinction coefficients for the antibody of interest at both target wavelengths entered in Multi-WL (item C above).
- Extinction Coefficient - Drug:** Enter the extinction coefficients for the drug of interest at both target wavelengths entered in Multi-WL (item C above).

**Note:** The user can select extinction coefficient units of  $M^{-1}cm^{-1}$  or  $ml/(mg \cdot cm)$ . All extinction coefficient fields will have the same units when one field is changed.

- Minimize Menu:** Click the black bar to hide the Method Input Menu.
- Scatter Correction:** Enable or disable an algorithm that subtracts the absorbance contribution due to molecular interactions with the incident light or particle dispersion. See section 4.2 for details.
- Rep Mode:** Enable to collect multiple slope measurements.
  - Repeat:** The instrument repeats the search algorithm and data collection without changing the Fibrette or sample vessel.
  - Replicate:** The instrument returns to the Home Position between measurements, allowing the user to change the Fibrette and sample vessel. Each replicate measurement consists of both the search algorithm and data collection.
- Pathlength:** This parameter appears differently depending on the Slope Mode (item A above) selected.
  - In **Quick Mode**, the user can set the target absorbance, search pathlengths, and number of data points. The system will find the target absorbance by making successive measurements at the search pathlengths, then collect the specified number of data points by incrementally decreasing the pathlength.
  - In **Fixed Mode**, the user can set the starting pathlength, step size, and number of data points. The system will measure the absorbance beginning at the starting pathlength and then collect data at each step (decreasing the pathlength) until it reaches the specified number of data points.
- Baseline Correction:** Enable or disable an algorithm that subtracts the absorbance contribution due to the buffer. When enabled, a baseline measurement but be collected before the run can begin.

Figure 32. ADC Instrument Controls



### Instrument Controls

Instrument controls can be found in the upper-right corner of the application. The following indicators and functions are displayed in **Error! Reference source not found.**:

- A. **ViPER Status:** Displays the status of the system.
- B. **Instrument Status:** Displays the VPT device currently connected.
- C. **Home Button:** Click to send the device to the Home Position (maximum pathlength).
- D. **Collect Button:** Click to initiate data collection using the current method parameters.
  - The Baseline button appears instead of the Collect button when Baseline Correction is turned on. After performing baseline correction, the Collect button appears.

### Your Quick View

Your Quick View can be found on the right panel of every application and provides a snapshot of the data collected. The window can be expanded by clicking the double arrow icon. Fields can be shown or hidden by clicking the ellipsis (...) in the Quick View header bar. The following fields can be displayed:

- Antibody Concentration
- Drug Concentration
- DAR
- Baseline
- User Result

### Sample Details

The sample name must be entered in the field below the navigation bar before beginning data collection. Click the ellipsis (...) next to the text box to enter additional information about the sample.

Figure 33. ADC Sample Field



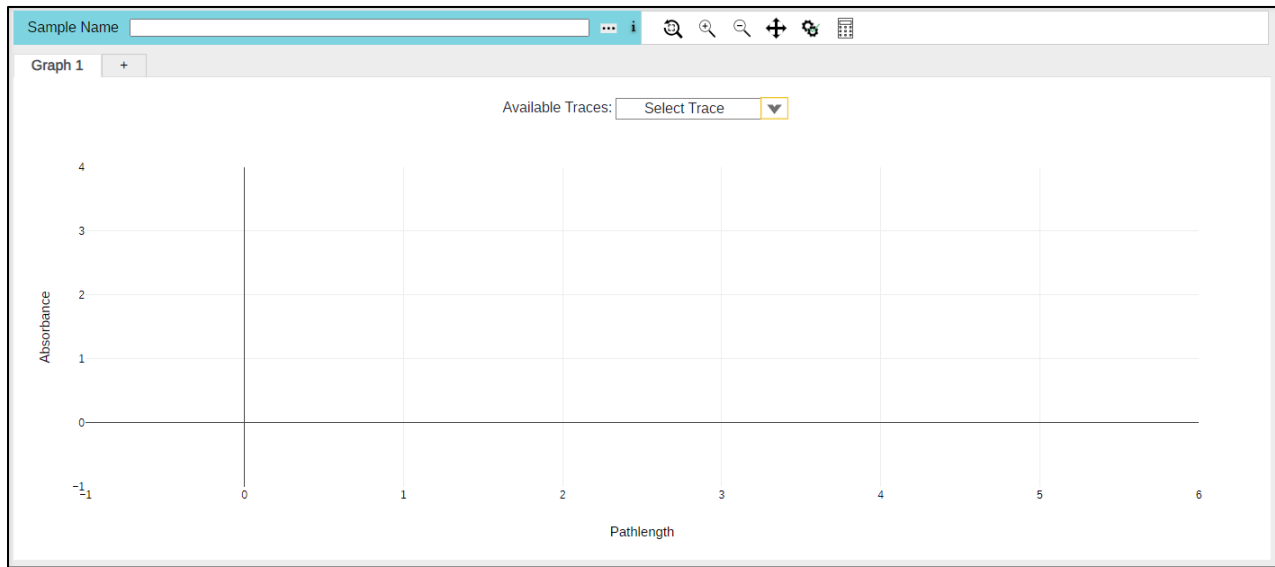
### Graph Viewer and Tools

The graph viewer displays all data collected.

- Click the “+” tab at the top of the graph area to open a blank graph for new data to be collected and plotted.
- Navigate between data plots by clicking the Graph 1, Graph 2, etc. tabs.
- Select a trace from the drop-down menu above the graph to hide all data except the selected trace.
- Click and drag within the graph area to zoom in on a specific region of the graph.

The tools above the graph are explained in Table 11.

Figure 34. ADC Graph Viewer



### Navigation Bar

The navigation bar can be found at the top of the application and contains the following actions:

Table 11. ADC Graphing Tools

Icon	Label	Description
	Zoom Reset	Resets the graph to the default view.
	Zoom In	Zooms in.
	Zoom Out	Zooms out.
	Pan	Allows the user to click and drag to pan across the graph area.
	Acceptance Criteria	Allows the user to set a value for genome titer, capsid titer, and % full capsids for easy identification of acceptable results.
	Calculator	Allows the user to define custom calculations. Calculations must be defined prior to starting data acquisition. Upon completing the method, the results of user-defined calculations are shown in Your Quick View and added to the report.

### Report Viewer

Results are displayed here. There are four reporting tabs:

- **Reporter:** Displays all data collected, in addition to information about the VPT device, method, and security.
- **Slope Data:** Displays the results calculated from the data collected, including slope,  $R^2$ , and wavelength.
- **Raw Data:** Displays the collection of discrete absorbance measurements at corresponding pathlengths and wavelengths.
- **ADC Data:** Displays the slope in Abs/mm for the antibody and drug at the corresponding wavelengths entered in the Method Input Menu, as well as antibody and drug concentration in either mol/L or mg/mL, depending on the extinction coefficient units selected in the Method Input Menu. The DAR is also calculated and displayed.



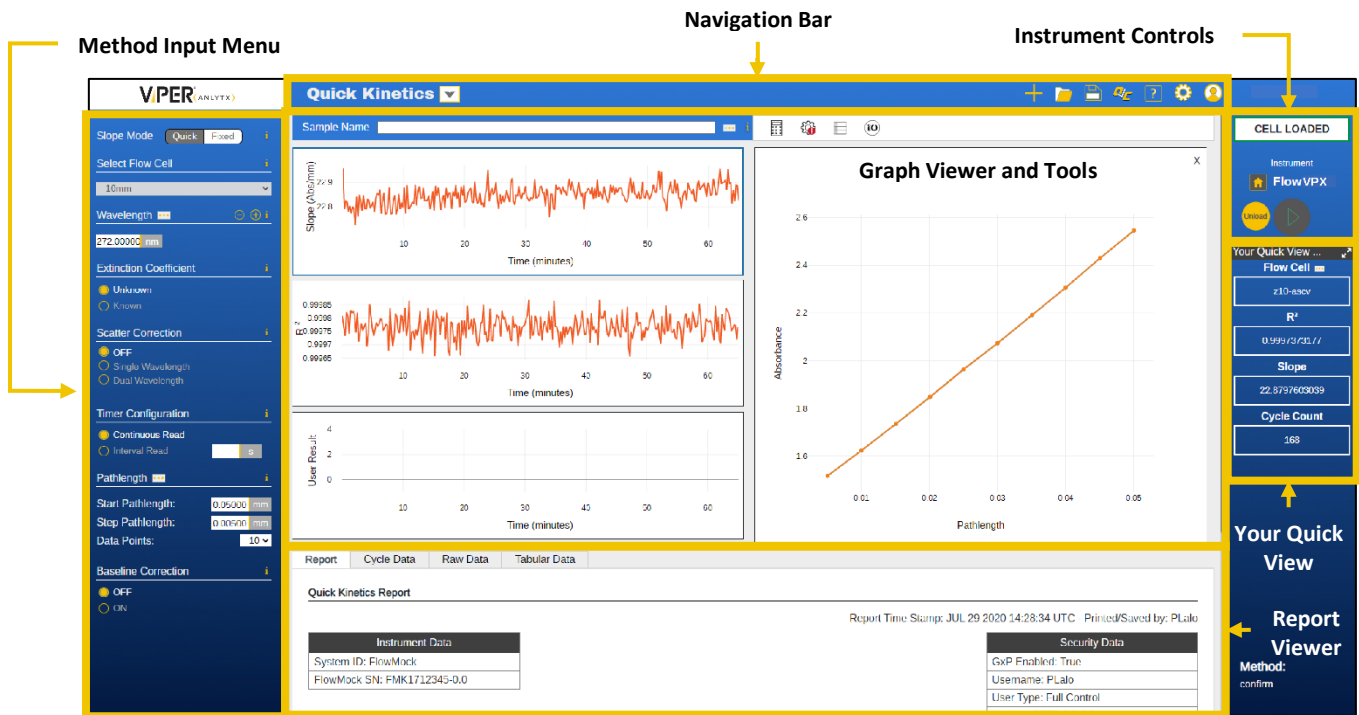
Performance test results that have been recorded in the Validate VPT Log can be added to the report by clicking on the Quick Check icon (pictured left) in the navigation bar. Select Validate VPT or System Suitability from the drop-down menu, then click on any test result to add it to the report.

Once data has been collected, the user can access the Report Wizard to configure the report; see section 4.1 for details.

### 3.7 Quick Kinetics

The Quick Kinetics application is compatible with the FlowVPX System. This application monitors a process stream and graphs data over time. The reporting features allow the user to export data in a variety of formats.

Figure 35. Quick Kinetics application: menus and sections.









#### Navigation Bar

The navigation bar can be found at the top of the application and contains the following actions:

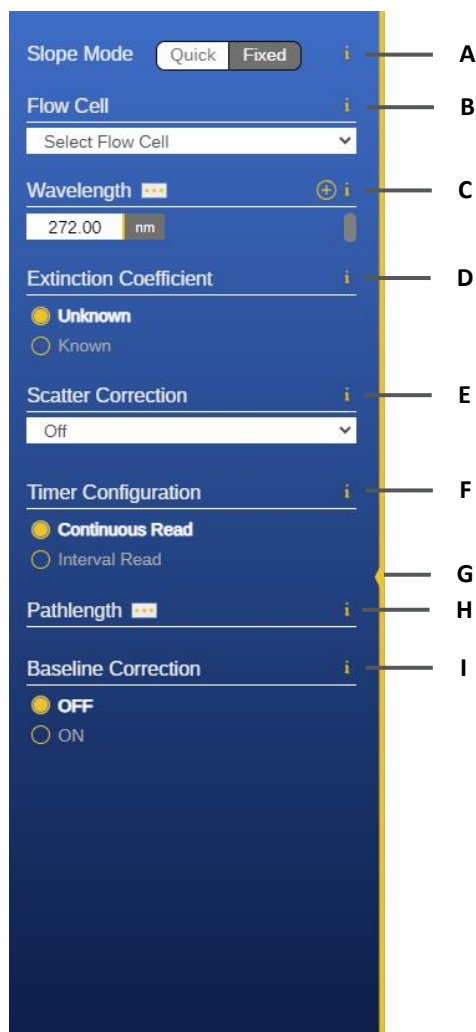
Table 12. Quick Kinetics Navigation Bar Icons

Symbol	Name	Options	Description
	Available Apps	—	Click to change to another application.
	Reset	Reset Run	Clears the data collected but does not modify the Method Input menu.
		Reset Method	Resets the method to the admin-configured default settings but does not clear the data.
		Reset All	Clears the data and resets method to the admin-configured default settings.
	Open	Open Method	Opens a data table with all previously saved methods organized by name, date saved, user, and application. Users can search by method name and filter by user and application.
		Open Data	Opens a data table with all previously collected data organized by sample name, date saved, and the user who collected the data. Users can search by DAQ ID, method name, and date saved; users can also filter by user and date. All data collected is autosaved by sample name.
		Open Report	Opens a data table with previously saved reports organized by name of report, date saved, and the user who created the report.

	<b>Save</b>	Save Method	Saves method to the database.
		Save Report	Saves report to the database.
	<b>Export</b>	Export Method	Exports the configured method as a .ctm file. The file is saved to the default downloads location as determined by the user's Chrome settings.
		Export Data	Exports the data collected as either an .xlsx (Excel) or .csv file. The file is saved to the default downloads location as determined by the user's Chrome settings.
		Export Report	Exports the report as a .pdf file. The file is saved to the default downloads location as determined by the user's Chrome settings.
	<b>Quick Check</b>	—	Opens the Validate VPT log, showing recent performance tests. The user can click on any test from the log and add it to the current report. The user can also initiate a Quick Check and/or Coupler Check by clicking the buttons in the right panel.
	<b>Help</b>	—	Opens the user guide.
	<b>Settings</b>	Method Detail	Displays parameters of the last method run.
		Audit Log	Opens the Audit Log.
	<b>User Options</b>	—	Click to log out of ViPER.

See next page for the sections of the Quick Kinetics Method Input Menu.

Figure 36. Quick Kinetics Method Input Menu

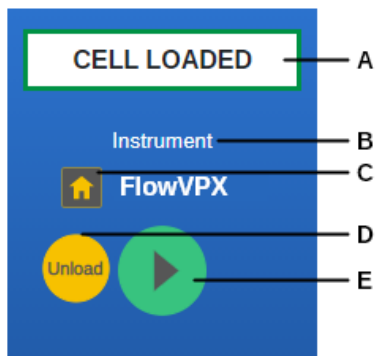


### Method Input Menu

The method input menu is the left panel in the application workspace. This menu allows the user to configure parameters for method creation and data collection. The following functions are displayed in Figure 36:

- A. **Slope Mode:** Set the VPT device to Quick or Fixed mode. This option affects the parameters displayed under Pathlength (see item H below for details).
- B. **Flow Cell:** Select the size of the Flow Cell that will be loaded into the instrument.
- C. **Wavelength:** Enter a range from 190 nm to 1100 nm.
  - To measure at multiple wavelengths, click (+) to add another wavelength.
  - Click the ellipsis (...) to change the averaging time.
  - For Beams users, the wavelength field is not editable and multi-wavelength is not available.
  - For Beams users, click the ellipsis (...) and then click Initialize Beams to connect or re-connect ViPER to the Beams light source.
- D. **Extinction Coefficient:** If known, the system can calculate the concentration of the sample.
  - If multiple wavelengths are entered, the user can enter an extinction coefficient for each wavelength. This is not applicable for Beams users.
- E. **Scatter Correction:** Enable or disable an algorithm that subtracts the absorbance contribution due to molecular interactions with the incident light or particle dispersion. See section 4.2 for details.
  - Scatter Correction is not available for Beams users.
- F. **Timer Configuration:** Choose whether the system will collect data continuously or at set intervals.
- G. **Minimize Menu:** Click the yellow bar to hide the Method Input Menu.
- H. **Pathlength:** This parameter appears differently depending on the Slope Mode (item A above) selected.
  - In **Quick Mode**, the user can set the target absorbance, search pathlength, and number of data points. The system will find the target absorbance by making successive measurements at the search pathlengths, then collect the specified number of data points by incrementally decreasing the pathlength.
  - In **Fixed Mode**, the user can set the starting pathlength, step size, and number of data points. The system will measure the absorbance beginning at the starting pathlength and then collect data at each step (decreasing the pathlength) until it reaches the specified number of data points.
- I. **Baseline Correction:** Enable or disable an algorithm that subtracts the absorbance contribution due to the buffer. When enabled, a baseline measurement must be collected before the run can begin.

**Figure 37. Quick Kinetics Instrument Controls** **Instrument Controls**



Instrument controls can be found in the upper right corner of the application. The following indicators and functions are displayed in Figure 37:

- A. **ViPER Status:** Displays the status of the system.
- B. **Instrument Status:** Displays the VPT device currently connected.
- C. **Home Button:** Click to send the device to the Home Position (maximum pathlength).
- D. **Load/Unload Button:** Click to launch instructions to either load or unload a Flow Cell.
- E. **Collect Button:** Click to initiate data collection using the current method parameters.
  - The Baseline button appears instead of the Collect button when Baseline Correction is turned on. After performing baseline correction, the Collect button appears.

### Your Quick View

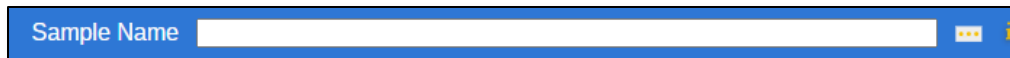
Your Quick View can be found on the right panel of every application and provides a snapshot of the data collected. The window can be expanded by clicking the double arrow icon. Fields can be shown or hidden by clicking the ellipsis (...) in the Quick View header bar. The following fields can be displayed:

- Flow Cell
- Concentration
- $R^2$
- Slope
- Cycle Count
- Elapsed Time
- User Result

### Sample Details

The sample name must be entered in the field below the navigation bar before beginning data collection. Click the ellipsis (...) next to the text box to enter additional information about the sample.

**Figure 38. Quick Kinetics Sample Name Field**



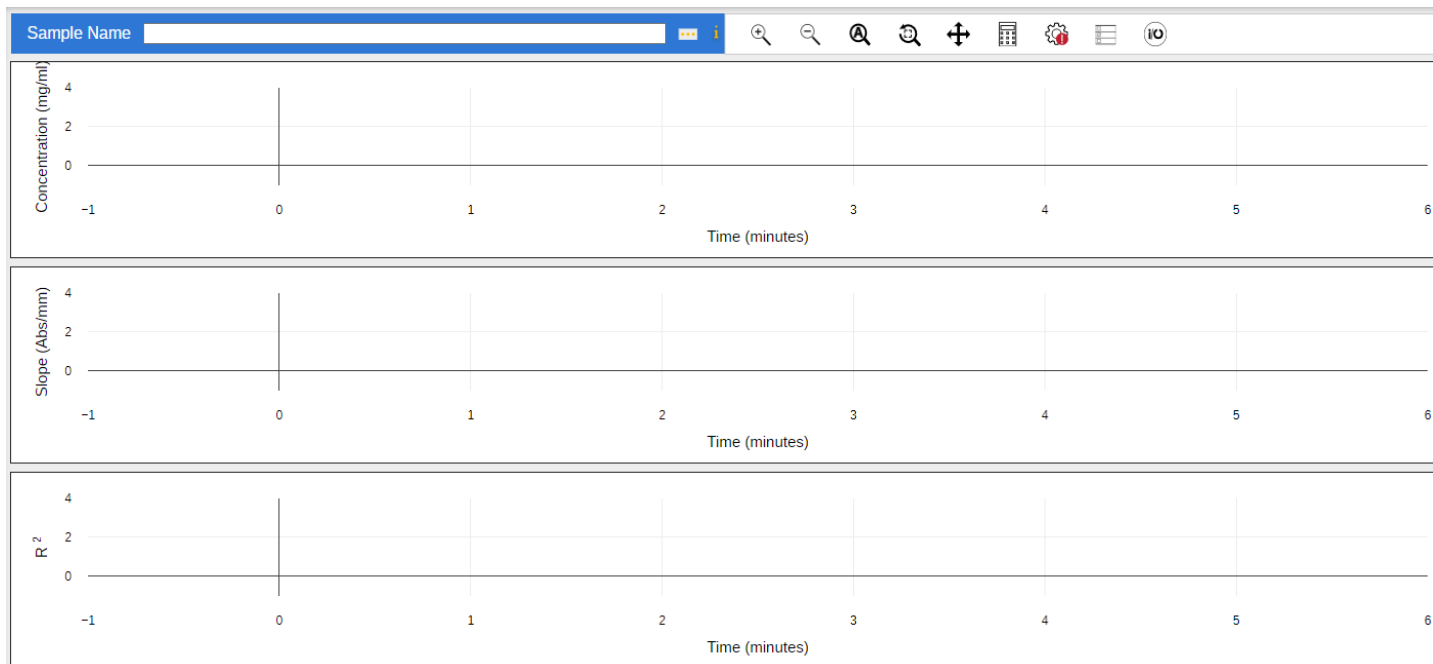
### Graph Viewer and Tools

The graph viewer displays the data collected in 3 graphs: Concentration (mg/ml), Slope (Abs/mm), and  $R^2$ . All graphs are plotted with Time (minutes) on the x-axis. The graphs are interactive and can be enlarged by double-clicking in the graph area. The tools above the graph are explained in Table 13.

If no extinction coefficient is entered in the Method Input Menu, the Concentration graph will not be displayed.



Figure 39. Quick Kinetics Graph Viewer



### Navigation Bar

The navigation bar can be found at the top of the application and contains the following actions:

Table 13. Quick Kinetics Graphing Tools

Icon	Label	Description
	Zoom Reset	Resets the graph to the default view.
	Zoom In	Zooms in all graphs.
	Zoom Out	Zooms out all graphs.
	Auto Scale	Toggles autoscaling on or off. When turned on, the graph boundaries will update when necessary to show all data. Users must enter the upper and lower limits for Concentration, Slope, R <sup>2</sup> , and/or User Result.
	Pan	Allows the user to click and drag to pan across the graph area. All graphs will pan left and right (x-axis) to display the same time interval; only the graph that is clicked can pan up and down (y-axis).
	Calculator	Allows the user to define custom calculations. Calculations must be defined prior to starting data acquisition. Calculations are taken over time. Upon cycle completion, the results of user-defined calculations are also graphed and shown in the report.
	Set Value Trigger	Creates alerts on the graph when defined criteria are met.
	Configure Graphs	Selects which graphs to display.
	Configure I/O	Sets a voltage or current output signal to an accompanying National Instrument DAQ box. The voltage/current signal can be configured to correspond to specified Slope, R <sup>2</sup> , Concentration, or User Result values.

### Report Viewer

Results are displayed here. There are four reporting tabs:

- Reporter:** Displays all data collected, in addition to information about the VPT device, light source, method configurations, run details, and security.

- **Cycle Data:** Displays the calculated results of the raw data that coincide with each cycle. This includes the slope,  $R^2$ , User Result, and concentration (if an extinction coefficient was entered).
- **Raw Data:** Displays the collection of discrete absorbance measurements at corresponding pathlength values and the time each data point was acquired.
- **Tabular Data:** Displays the collection of data calculated by the user-defined calculator (if applicable) and concentration data (if an extinction coefficient was entered).



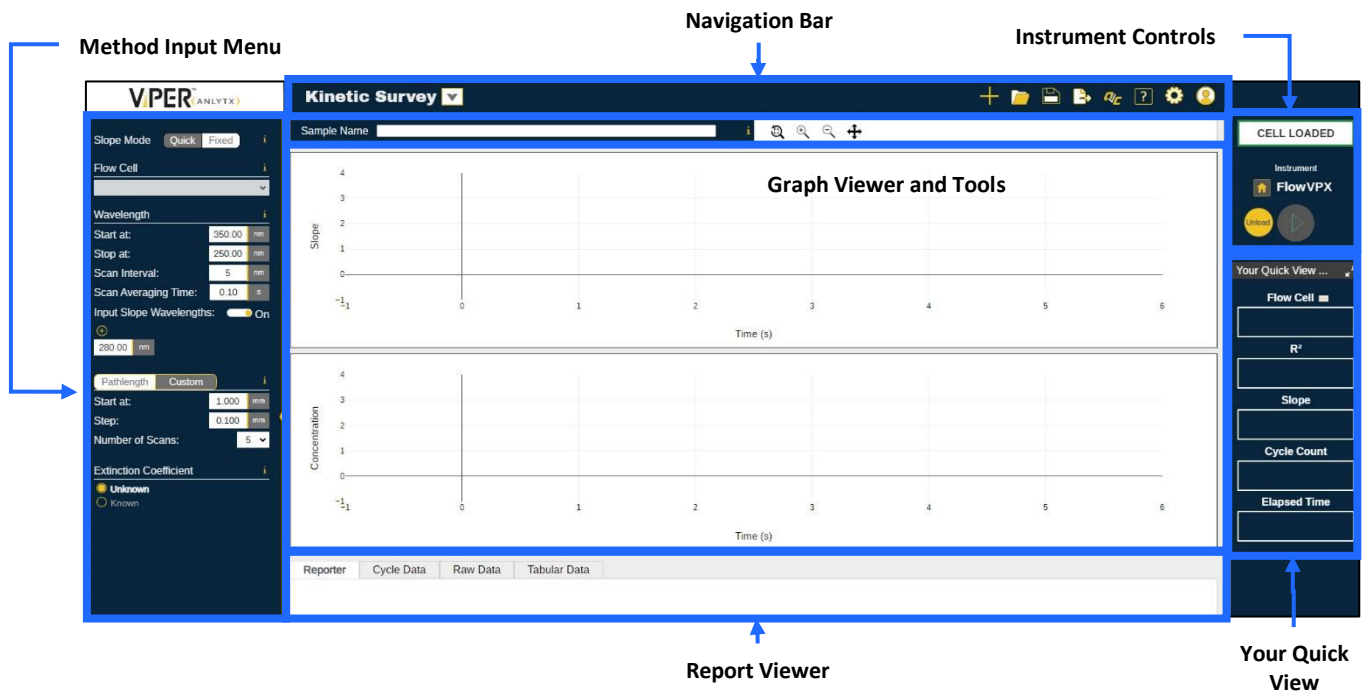
Performance test results that have been recorded in the Validate VPT Log can be added to the report by clicking on the Quick Check icon (pictured left) in the navigation bar. Select Validate VPT or System Suitability from the drop-down menu, then click on any test result to add it to the report.

Once data has been collected, the user can access the Report Wizard to configure the report; see section 4.1 for details.

### 3.8 Kinetic Survey

The Kinetic Survey application is compatible with the FlowVPX System. This application collects absorbance vs. pathlength data over a wavelength range specified by the user. Data can be viewed as slope over time and concentration over time, if the extinction coefficient is known.

Figure 40. Kinetic Survey application: menus and sections.











#### Navigation Bar

The navigation bar can be found at the top of the application and contains the following actions:

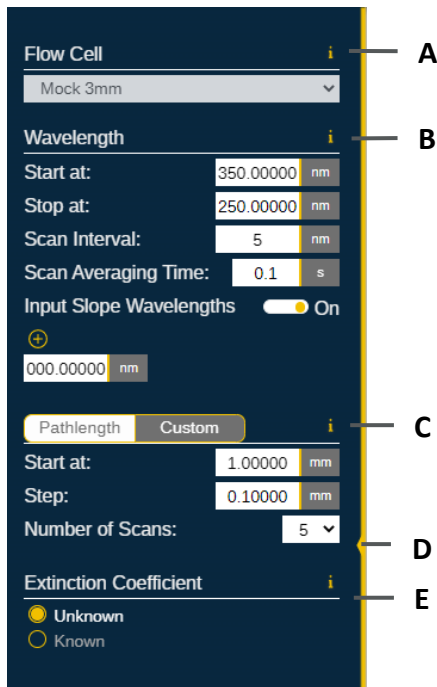
Table 14. Kinetic Survey Navigation Bar Icons

Symbol	Name	Options	Description
	Available Apps	—	Click to change to another application.

	<b>Reset</b>	Reset Run	Clears the data collected but does not modify the Method Input menu.
		Reset Method	Resets the method to the admin-configured default settings but does not clear the data.
		Reset All	Clears the data and resets method to the admin-configured default settings.
	<b>Open</b>	Open Method	Opens a data table with all previously saved methods organized by name, date saved, user, and application. Users can search by method name and filter by user and application.
		Open Data	Opens a data table with all previously collected data organized by sample name, date saved, and the user who collected the data. Users can search by DAQ ID, method name, and date saved; users can also filter by user and date. All data collected is autosaved by sample name.
		Open Report	Opens a data table with previously saved reports organized by name of report, date saved, and the user who created the report.
	<b>Save</b>	Save Method	Saves method to the database.
		Save Report	Saves report to the database.
	<b>Export</b>	Export Method	Exports the configured method as a .ctm file. The file is saved to the default downloads location as determined by the user's Chrome settings.
		Export Data	Exports the data collected as either an .xlsx (Excel) or .csv file. The file is saved to the default downloads location as determined by the user's Chrome settings.
		Export Report	Exports the report as a .pdf file. The file is saved to the default downloads location as determined by the user's Chrome settings.
	<b>Quick Check</b>	—	Opens the Validate VPT log, showing recent performance tests. The user can click on any test from the log and add it to the current report. The user can also initiate a Quick Check and/or Coupler Check by clicking the buttons in the right panel.
	<b>Help</b>	—	Opens the user guide.
	<b>Settings</b>	Method Detail	Displays parameters of the last method run.
		Audit Log	Opens the Audit Log.
	<b>User Options</b>	—	Click to log out of ViPER.

See next page for the sections of the Kinetic Survey Method Input Menu.

Figure 41. Kinetic Survey Method Input Menu

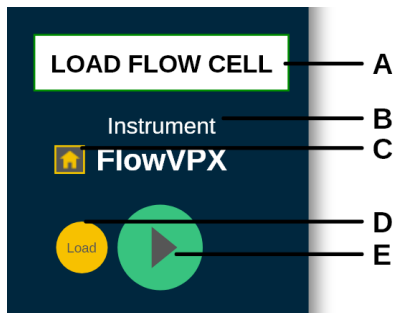


### Method Input Menu

The method input menu is the left panel in the application workspace. This menu allows the user to configure parameters for method creation and data collection. The following functions are displayed in Figure 41:

- A. **Flow Cell:** Select the size of the Flow Cell that will be loaded into the instrument.
- B. **Wavelength:** Enter a Start wavelength and Stop wavelength between 190 nm and 1100 nm.
  - The Scan Interval dictates the step size between wavelengths at which the system will collect absorbance vs. pathlength data.
  - Toggle on Input Slope Wavelengths to enter specific wavelengths where the system will collect absorbance vs. pathlength data.
- C. **Pathlength:** This parameter appears differently depending on the Slope Mode (item A above) selected.
  - In **Quick Mode**, the user can set the target absorbance, search pathlength, and number of data points. The system will find the target absorbance by making successive measurements at the search pathlengths, then collect the specified number of data points by incrementally decreasing the pathlength.
  - In **Fixed Mode**, the user can set the starting pathlength, step size, and number of data points. The system will measure the absorbance beginning at the starting pathlength and then collect data at each step (decreasing the pathlength) until it reaches the specified number of data points.
- D. **Minimize Menu:** Click the yellow bar to hide the Method Input Menu.
- E. **Extinction Coefficient:** If known, the system can calculate the concentration of the sample.
  - If Input Slope Wavelengths is turned on, the user can enter an extinction coefficient for each wavelength specified.

Figure 42. Kinetic Survey Instrument Controls



### Instrument Controls

Instrument controls can be found in the upper-right corner of the application. The following indicators and functions are displayed in Figure 42:

- A. **VIPER Status:** Displays the status of the system.
- B. **Instrument Status:** Displays the VPT device currently connected.
- C. **Home Button:** Click to send the device to the Home Position (maximum pathlength).
- D. **Load/Unload Button:** Click to launch instructions to either load or unload a Flow Cell.
- E. **Collect Button:** Click to initiate data collection using the current method parameters.
  - The Baseline button appears instead of the Collect button when Baseline Correction is turned on. After performing baseline correction, the Collect button appears.

### Your Quick View

Your Quick View can be found on the right panel of every application and provides a snapshot of the data collected. The window can be expanded by clicking the double arrow icon. Fields can be shown or hidden by clicking the ellipsis (...) in the Quick View header bar. The following fields can be displayed:

- Flow Cell
- Concentration

- $R^2$
- Slope
- Cycle Count
- Elapsed Time

### Sample Details

The sample name must be entered in the field below the navigation bar before beginning data collection. Click the ellipsis (...) next to the text box to enter additional information about the sample.

Figure 43. Kinetic Survey Sample Name Field

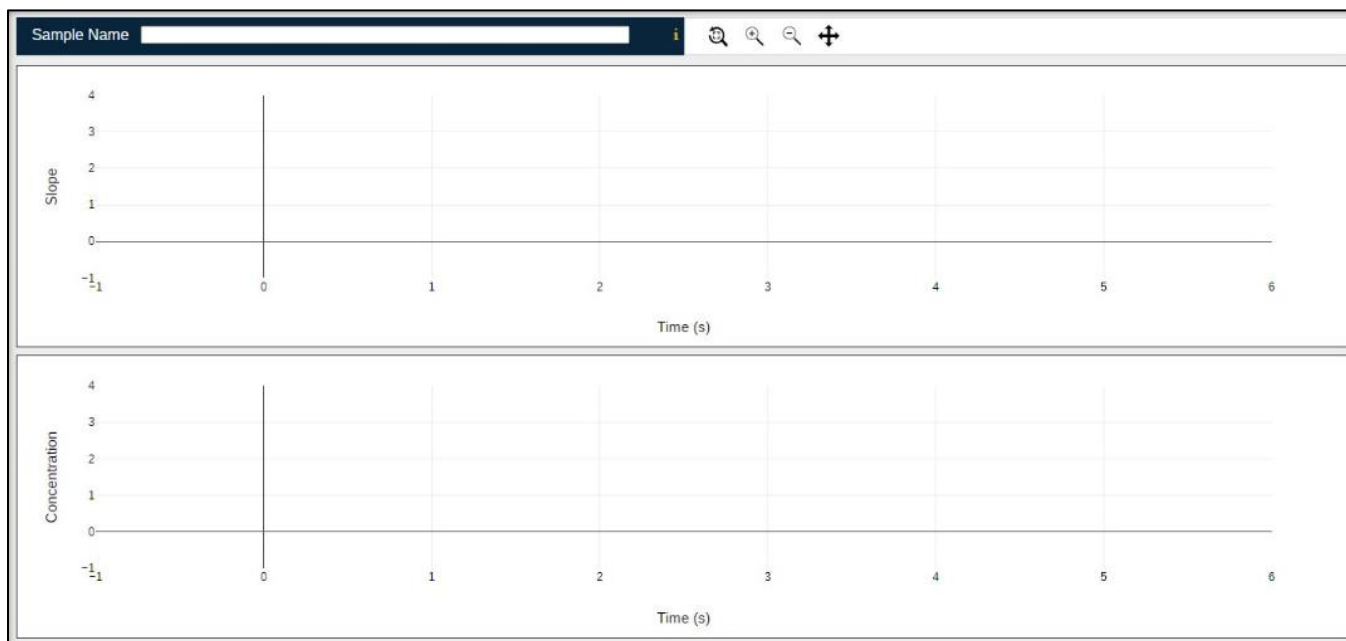


### Graph Viewer and Tools

The graphs display slope and concentration data from the current or most recent run. The tools above the graph can be used to zoom in and out. Click and drag in the graph area to zoom in on a specific region of the graph. After selecting the Pan tool, click and drag to move the region shown. When zooming or panning, both graphs will adjust to show the same time interval (x-axis).

If no extinction coefficient is entered in the Method Input Menu, the Concentration graph will not be displayed.

Figure 44. Kinetic Survey Graph Viewer



### Report Viewer

Results are displayed here. There are four reporting tabs:

- **Reporter:** Displays all data collected, in addition to information about the VPT device, method, and security.
- **Cycle Data:** Displays the calculated results of the raw data that coincide with each cycle. This includes the slope,  $R^2$ , and concentration (if an extinction coefficient was entered).
- **Raw Data:** Displays the collection of discrete absorbance measurements at corresponding pathlength values and the time each data point was acquired.

- **Tabular Data:** Displays the collection of data calculated by the user-defined calculator (if applicable) and concentration data (if an extinction coefficient was entered)



Performance test results that have been recorded in the Validate VPT Log can be added to the report by clicking on the Quick Check icon (pictured left) in the navigation bar. Select Validate VPT or System Suitability from the drop-down menu, then click on any test result to add it to the report.

Once data has been collected, the user can access the Report Wizard to configure the report; see section 4.1 for details.

## 4. Feature Descriptions

This chapter provides detailed information on select features and functionality that may be accessed via multiple ViPER applications.

### 4.1 Report Wizard

ViPER applications that are used for data collection are able to export results in a report. The parameters included on the report can be configured using the Report Wizard (Figure 45); a button to access the Report Wizard appears in the application after at least one method is run.

Reports can be customized in the following ways:

- Toggle to show (On) or hide (Off) sections in the report. Grayed out sections are not available due to the method parameters.
- Click and drag section names to rearrange the order.
- Add comments to the report.
- Download the report as a PDF.
- Print the report to a connected printer.

A preview of the report is displayed on the right side of the Report Wizard.



Performance test results that have been recorded in the Validate VPT Log can be added to the report by clicking on the Quick Check icon (pictured left) in the navigation bar. Select Validate VPT or System Suitability from the drop-down menu, then click on any test result to add it to the report.

Figure 45. Report Wizard example

The screenshot shows the 'My Report Wizard' interface. On the left is a configuration panel with various sections and their status (On/Off). On the right is a preview of the generated report, which includes the ViPER ANALYTIX and REPLIGEN logos, instrument data, security data, method configuration, run details, a graph of Absorbance vs Pathlength, and summary tables for VPT and Audit Log.

Instrument Data		Security Data	
System ID:	Laborator	Username:	J.Smith
Serial Number:		User Type:	Admin
		Version:	1.0.75.0

Quick Slope Method Configuration			
Slope Mode:	Quick	Sample Vessel:	Small
Wavelength (nm):	280.00000	Extinction Coefficient (ml/mg*cm):	Unknown
Averaging Time (s):	0.50000	Rep Mode:	OFF
Scatter Correction (nm):	OFF	Baseline Correction:	OFF
Target Absorbance (Abs):	1	Search Pathlengths (mm):	0.05000, 0.03000, 0.01000
Data Points:	5	User Result:	N/A
Method:	N/A		

Run Details	
Sample Name:	Example
Run Initiated (UTC):	MAY 05 2021 16:51:57
Run Stopped (UTC):	MAY 05 2021 16:52:13

Validate VPT Summary									
ID	Type	Status	Time Stamp (UTC)	Device	Wavelength (nm)	Raw Transmission Ratio (%)	Username	Coupler Check ID	Comment
72144	Quick Check	15.17520%	MAY 04 2021 22:13:58	Martin (CTFXA200002)	250.00000	15.17520	csupport	72143	N/A
72144	Quick Check	Invalid: 102.57258%	MAY 04 2021 22:13:58	Martin (CTFXA200002)	500.00000	30.68951	csupport	72143	N/A
72143	Coupler Check	29.90030%T	MAY 04 2021 22:13:12	Martin (CTFXA200002)	500.00000	29.90030	csupport	N/A	N/A

Audit Log						
Username	Device	App	Event Type	Action	Old Value/New Value	Reason

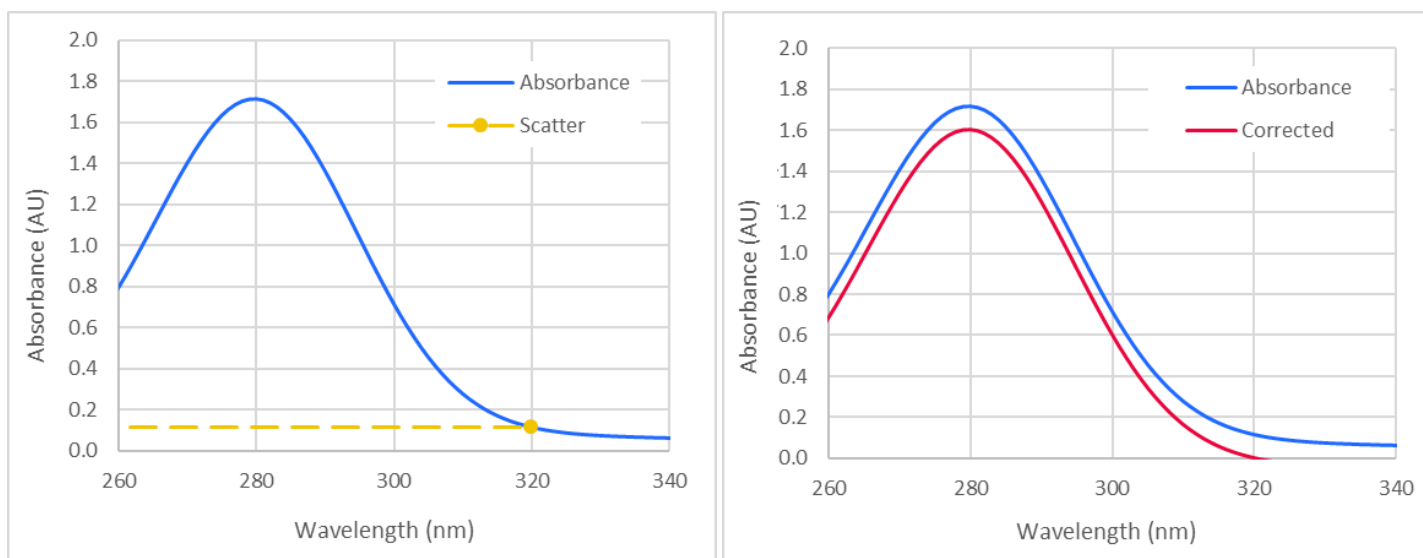
## 4.2 Scatter Correction

The Quick Slope, Quick Kinetics, and ADC applications feature an optional scatter correction algorithm which can be enabled to eliminate the contribution to measured absorbance due to light scattering. Four scatter correction methods are available. The algorithms are described below.

### Single Wavelength Scatter Correction

1. Measure absorbance at the scatter wavelength, where the molecule of interest is expected to have minimal absorbance.
2. Measure absorbance at the method wavelength, or wavelength of interest, and subtract the absorbance measured at the scatter wavelength. The result is a scatter-corrected absorbance measurement.

Figure 46. Graphical illustration of single-wavelength scatter correction



### Dual Wavelength Scatter Correction

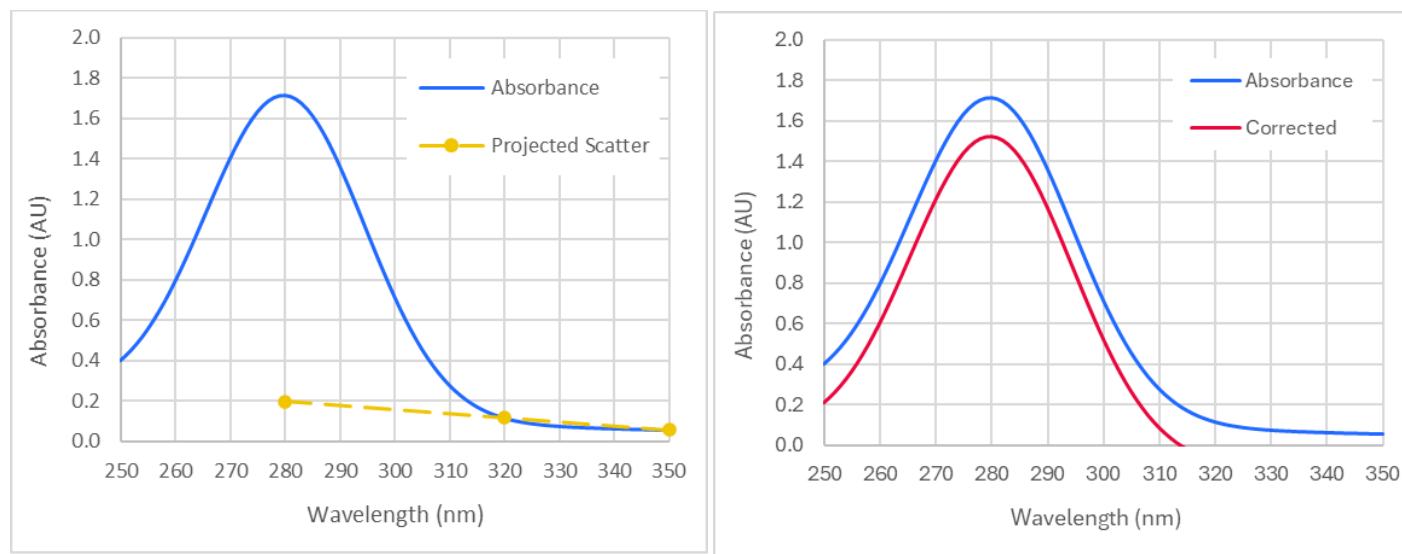
1. Measure absorbance at two scatter wavelengths, where the molecule of interest is expected to have minimal absorbance.
2. Calculate the slope  $m$  of the line that connects the two scatter data points:

$$m = \frac{y_2 - y_1}{x_2 - x_1}$$

3. Calculate the  $y$ -intercept  $b$  of the projected line:  $b = y_1 - mx_1$
4. Calculate the scatter contribution  $y_0$  at the method wavelength  $x_0$  using the linear equation  $y_0 = mx_0 + b$ .
5. Measure absorbance at the method wavelength and subtract  $y_0$ . The result is a scatter-corrected absorbance measurement.



Figure 47. Graphical illustration of dual-wavelength scatter correction



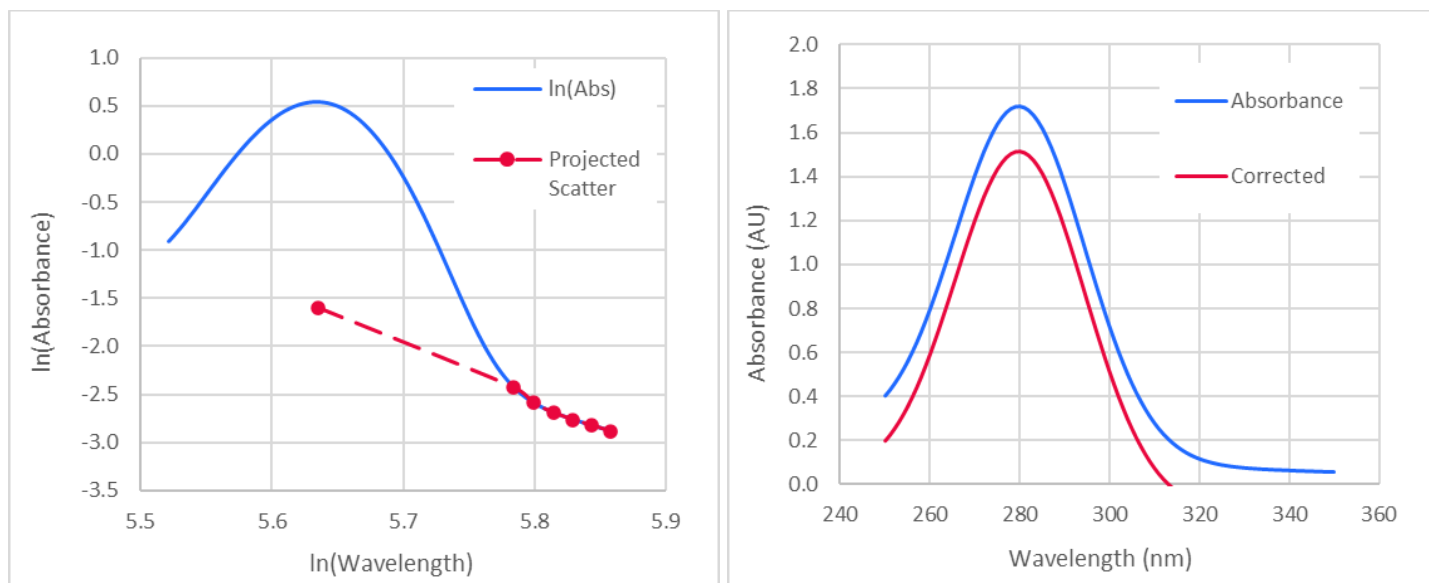
### Dual LN Scatter Correction

1. Measure absorbance at the upper and lower endpoints of the specified wavelength range and record absorbance  $A$  for each wavelength  $\lambda$ .
2. Take the natural log of the absorbance,  $\ln(A)$ , and the natural log of the wavelength,  $\ln(\lambda)$ , for each data point.
3. Calculate the slope  $m$  of the line that connects the two logarithmic scatter data points:

$$m = \frac{\ln(A_2) - \ln(A_1)}{\ln(\lambda_2) - \ln(\lambda_1)}$$

4. Calculate the  $y$ -intercept  $b$  of the projected line:  $b = \ln(A_1) - m \cdot \ln(\lambda_1)$
5. Calculate the logarithmic scatter contribution  $\ln(A_0)$  at the log method wavelength  $\ln(\lambda_0)$ , or wavelength of interest, using the equation  $\ln(A_0) = m \cdot \ln(\lambda_0) + b$ .
6. Convert the logarithmic scatter contribution back into an absorbance value by taking the inverse log.
7. Subtract the absorbance due to scattering from the raw absorbance data. The result is a scatter-corrected absorbance measurement.

Figure 48. Graphical illustration of Dual LN and Multi LN scatter correction



### Multi LN Scatter Correction

1. Scan the specified wavelength range at 5 nm intervals, and record absorbance  $A$  for each wavelength  $\lambda$ .
2. Take the natural log of the absorbance and wavelength values. Plot the graph of  $\ln(A)$  vs.  $\ln(\lambda)$ .
3. Calculate the slope of the log vs. log curve over the scatter wavelength range using linear regression to obtain an equation of the form  $\ln(A) = m \cdot \ln(\lambda) + b$ .
4. Calculate the logarithmic scatter contribution at the wavelength of interest using the scatter equation obtained in Step 3.
5. Convert the logarithmic scatter contribution back into an absorbance value by taking the inverse log.
6. Subtract the absorbance due to scattering from the raw absorbance data. The result is a scatter-corrected absorbance measurement.

The algorithm for Multi LN Scatter Correction is described in USP <1057>.

### 4.3 SoloVPE with Cary 60 Procedures

The following procedures involve interaction with the SoloVPE instrument, Cary 60 spectrophotometer, and ViPER software. Please read through and understand the required steps before beginning any procedure in this section.

#### 4.3.1 Coupler Check

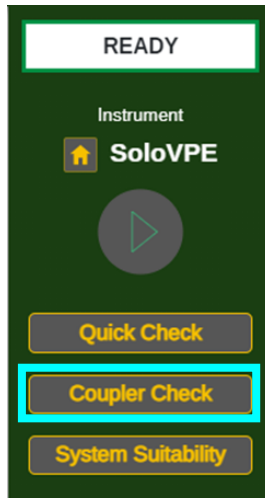
##### SoloVPE System with Cary 60

The Coupler Check test verifies adequate transmission from the Cary 60 light source through the Dual-Use Fiber Optic Coupler into the Delivery Fiber. Transmission is measured using the Transmission Tool and the SoloVPE detector. The Coupler Check result is used as the baseline measurement for the relative transmission reading in the Quick Check test (section 4.3.2).

The procedure below describes how to perform a Coupler Check using the Validate VPT application. A Coupler Check can be initiated from most ViPER applications.

1. Click the Coupler Check button on the Instrument Controls panel in the Validate VPT app.

Figure 49. Validate VPT Instrument Controls



2. Follow the prompt (Figure 50) to remove the Delivery Fiber from the Translation Stage by turning the FC connector end of the Delivery Fiber counter-clockwise (Figure 51). Attach the FC end of the Delivery Fiber to the Transmission Tool (Figure 52) and place both connected devices on top of the SoloVPE Detector Window (Figure 53). Be sure to align the notch on the Delivery Fiber to the keyway on the Transmission Tool.

Figure 50. Coupler Check window prompt.

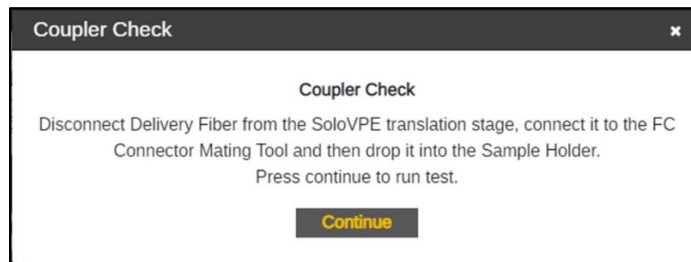
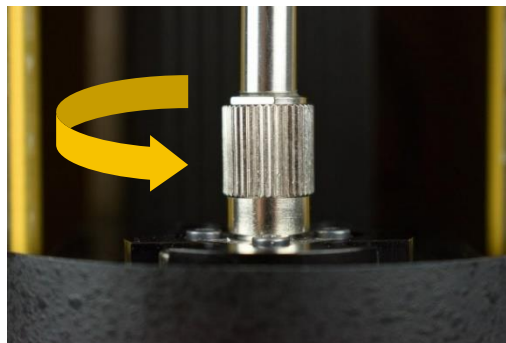
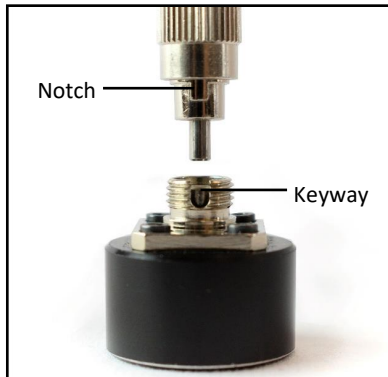


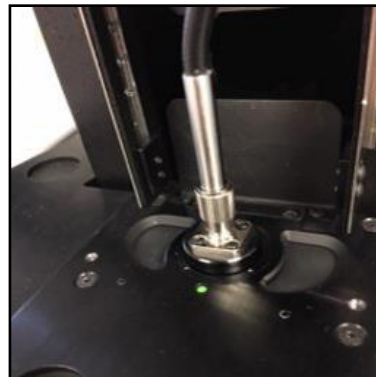
Figure 51. Disconnect Delivery Fiber from Translation Stage.



**Figure 52. Connect Delivery Fiber to Transmission Tool.**

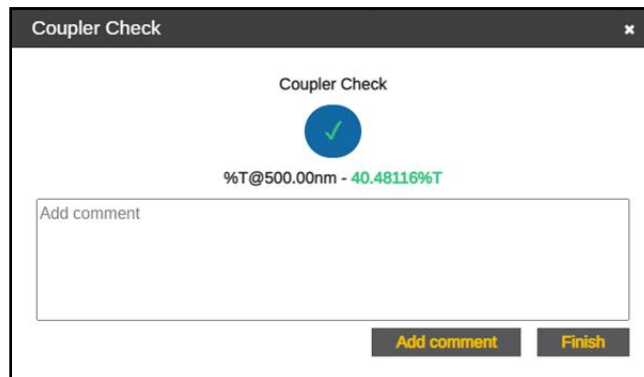


**Figure 53. Connect Transmission Tool to Translation Stage.**



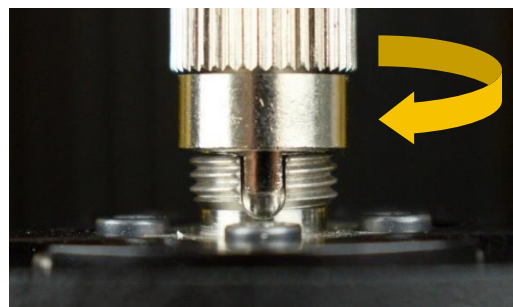
3. Click Continue on the prompt window when ready. The Coupler Check will then be performed.
4. Once completed, the results are displayed in the prompt window. User may add comments to be added to the Validation Check Log.
5. The system will also assess the change in transmission compared to the previous Coupler Check.
  - If the Coupler Check result surpasses the change threshold, a prompt recommending a system cleaning will appear. Perform the daily and weekly maintenance best practices and retry the Coupler Check once completed.
  - The threshold setting is configured within the App Configuration tab of Admin Settings. The default is 5.00%.

**Figure 54. Coupler Check window with Coupler Check results.**



1. Remove the Delivery Fiber from the SoloVPE device and detach the Fiber from the Transmission Tool.
2. Reinsert the Delivery Fiber through the top of the SoloVPE device via the Strain Relief and reattach it to the SoloVPE Translation Stage connection by aligning the notch into the keyway and rotating the FC connector end clockwise (Figure 55).

**Figure 55. Reconnect Delivery Fiber to Translation Stage.**



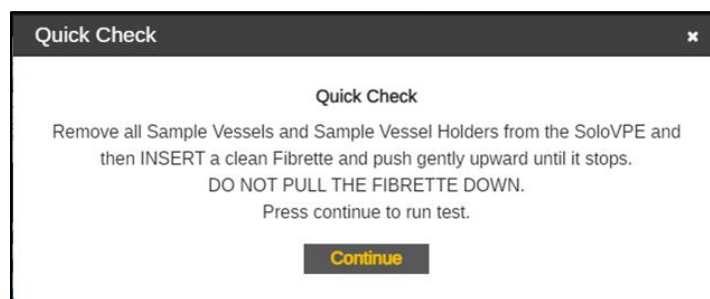
### 4.3.2 Quick Check

#### SoloVPE System with Cary 60

The Quick Check test measures transmission through the instrument when there is no sample present. The output displayed in the Quick Check window is the percent transmission relative to the result from the Coupler Check (section 4.3.1).

1. Click the Quick Check button on the Instrument Controls panel in the Validate VPT app.
2. ViPER will present a prompt instructing the user on how to prepare the Fibrette Optical Component and SoloVPE System for the test (Figure 56). It is critical that the test is run under the following conditions:
  - A clean, new Fibrette Optical Component should be pushed fully upward until it stops. Do not pull down.
  - The SoloVPE Detector Window should not have a sample vessel or sample vessel holder in place.
  - The SoloVPE cover should be in the down position.

Figure 56. Prepare for Quick Check window prompt and requirements.



3. Once the Fibrette Optical Component and SoloVPE System are prepared as described, click the Continue button to run the test.
  - Quick Check will automatically move the Fibrette Optical Component to make transmission measurements.
4. Once completed, the results will display the disposition of the SoloVPE System, which can be Pass or Fail (Figure 57, Figure 58). The user may add comments that will be recorded in the Validation Check Log.
  - A passing result means the system observed a transmission of 70.00% or greater at 500.00 nm. This number is derived from the baseline transmission using the Coupler Check.
  - A failed result means transmission is too low for most measurements, either through particulates, debris, or blockage in or in front of the optical path. Perform the Daily and Weekly Maintenance Best Practices and retry the Quick Check once completed.
  - The Pass/Fail criteria can be revised in the App Configuration tab in Admin Settings. Repligen recommends keeping this value at 70.00% for 500.00 nm.

Figure 57. Passed Quick Check.

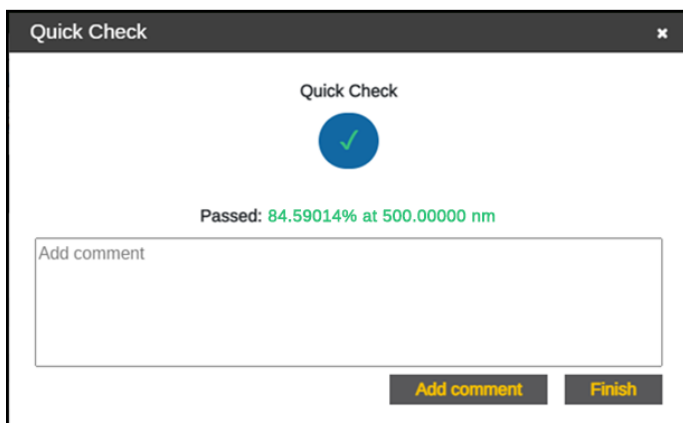
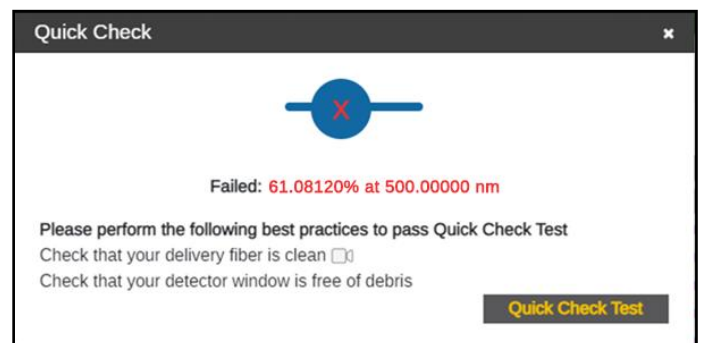


Figure 58. Failed Quick Check.



5. View your results in the Validation Check Log to see more details about the Quick Check results.
  - Filter Type allows the user to sort the results between All Types, Coupler Check, and Quick Check.
  - Users can define specific dates and times to find results. Press Apply after selecting the range of dates and times to see the search result.
6. Click Done to close the Quick Check window.

### 4.3.3 System Suitability Test

#### SoloVPE System with Cary 60

1. Open the Validate VPT app and click the System Suitability button in the Instrument Controls panel. Alternatively, a System Suitability Test can be initiated from the Quick Slope, AAV, or ADC applications by clicking the System Suitability button in the navigation bar.
2. Insert the reference standard into the sample vessel included with the DVA unit. Fill the vessel at least two-thirds full.
3. Select the appropriate reference standard from the list and enter the required information (Figure 59).
  - If the reference standard is unknown, choose Unknown Standard.

Figure 59. Reference Standard Information Fields

The figure displays three panels for entering reference standard information:

- ConfiRM Standard:** Fields include Part Number, Lot Number, Expiration Date (mm/dd/yyyy), Slope Target Value (Abs/mm), Uncertainty Value (Abs/mm), and Repeats (1).
- CHEM013 Standard:** Fields include Lot Number, Expected Slope (256 nm, 260 nm, 280 nm, 310 nm, 412 nm), Expiration Date (mm/dd/yyyy), Acceptable Variance (%), and Repeats (1).
- Unknown Standard:** Fields include Slope Mode (Quick/Fixed), Sample Name, Wavelength (nm), Averaging Time (.25 s), Search Pathlengths (mm), Target Absorbance (Abs), Data Points (5), Extinction Coefficient (ml/(mg\*cm)), Repeats (1), Expected Slope (Abs/mm), and Acceptable Variance (%).

4. Load the sample into the sample vessel holder and insert a clean, new Fibrette Optical Component into the Quick Set Coupler. Slide the SoloVPE cover down to block stray light from reaching the detector.
5. Click OK. Wait for the System Suitability Test to finish.
6. Test results will be added to the System Suitability Log. If the test was initiated through the Quick Slope or AAV app, the test result will be displayed in the report.

### 4.4 FlowVPX with Cary 60 Procedures

The following procedures involve interaction with the FlowVPX instrument, Cary 60 spectrophotometer, and VIPER software. Please read through and understand the required steps before beginning any procedure in this section.

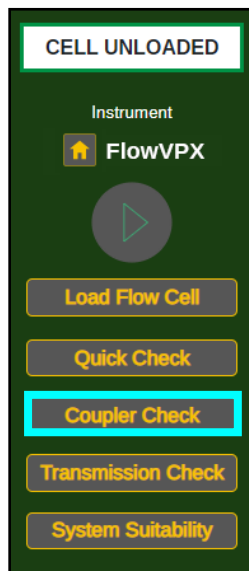
#### 4.4.1 Coupler Check

##### FlowVPX System with Cary 60

1. Launch the Validate VPT application.
2. Ensure the Flow Cell is unloaded to begin.

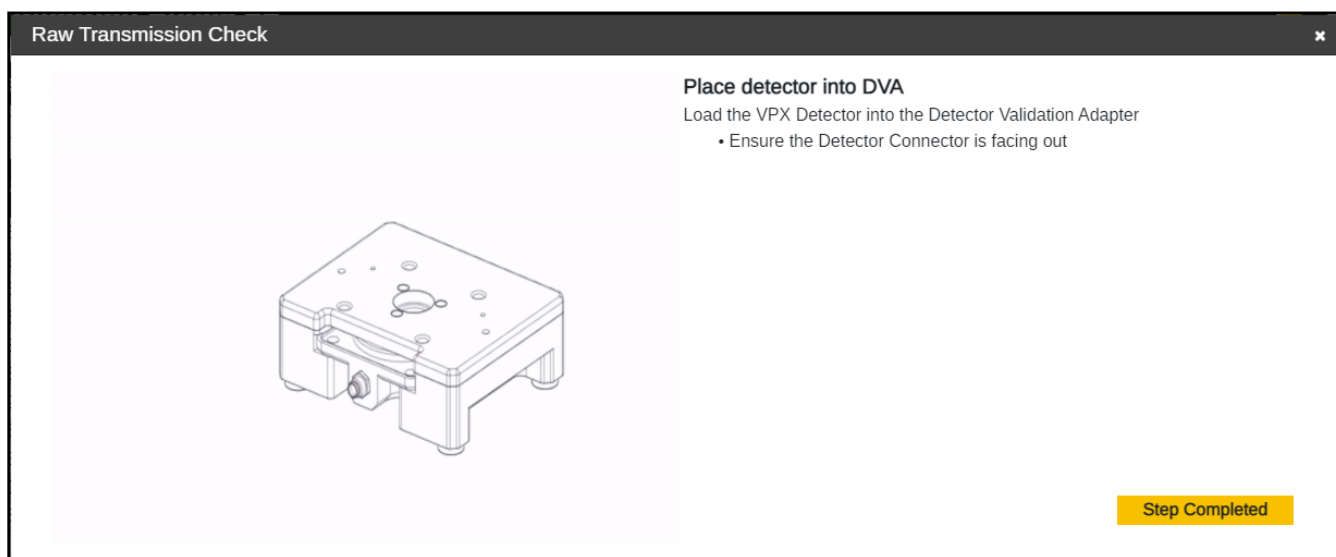
- Always ensure that no sample is flowing through the cell before unloading the Flow Cell. Otherwise, this may cause damage to the system and to the surrounding environment.
3. Click Coupler Check on the Instrument Controls panel to begin the process.

Figure 60. Coupler Check Button in Instrument Control Menu



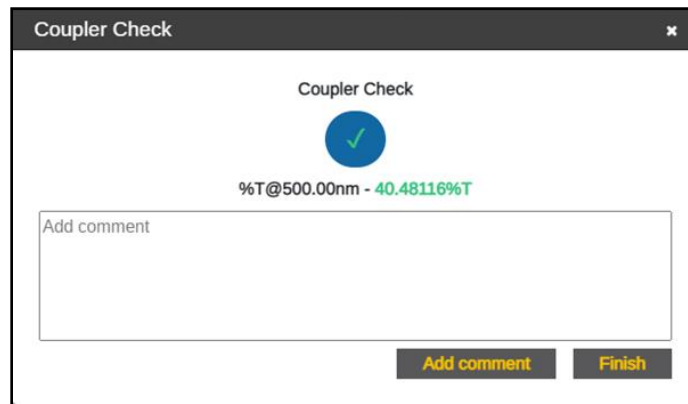
4. Click Continue and follow the on-screen prompts. Click Step Completed to proceed.

Figure 61. Coupler Check Instructions (Cary 60)



5. Load the FlowVPX Detector into the Detector Validation Adapter (DVA) unit (Figure 61). Ensure the Detector connector is facing out.
6. Connect the Delivery Fiber to the Transmission Tool. Ensure the key on the fiber connector lines up with the keyway from the Transmission Tool's FC adapter.
7. Place the Transmission Tool onto the DVA with the assistance of the magnets.
8. Please wait while ViPER runs the Coupler Check.

Figure 62. Coupler Check window with Coupler Check results.



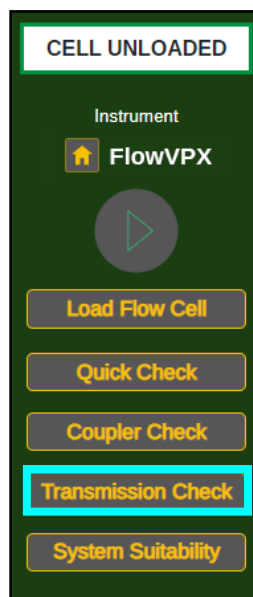
- If the Coupler Check fails and returns a result that surpasses the threshold, a prompt recommending a system clean will appear. Perform the daily and weekly maintenance best practices, and retry the Coupler Check once completed.
9. Click Finished.

#### 4.4.2 Transmission Check

##### FlowVPX System with Cary 60

1. Launch the Validate VPT application.
2. Ensure the Flow Cell is unloaded to begin.
  - Always ensure that no sample is flowing through the cell before unloading the Flow Cell. Otherwise, this may cause damage to the system and to the surrounding environment.
3. Click Transmission Check on the Instrument Controls panel to begin the process.

Figure 63. Transmission Check Button in Instrument Control Menu



4. Click Continue and follow the on-screen prompts. Click Step Completed to proceed.
5. Load the FlowVPX Detector into the Detector Validation Adapter (DVA) unit (Figure 61). Ensure the Detector connector is facing out.



6. Connect the Delivery Fiber to the Transmission Tool. Ensure the key on the fiber connector lines up with the keyway from the Transmission Tool's FC adapter.
7. Place the Transmission Tool onto the DVA with the assistance of the magnets.
8. Enter the wavelength(s) in the fields provided, which will determine at which wavelength(s) the system will take a reading.
9. Please wait while ViPER runs a transmission test for each wavelength entered.
10. Click Finished once the transmission test(s) are complete. The user may retry the check if the %T value is not within acceptable range.

#### 4.4.3 Quick Check

##### FlowVPX System with Cary 60

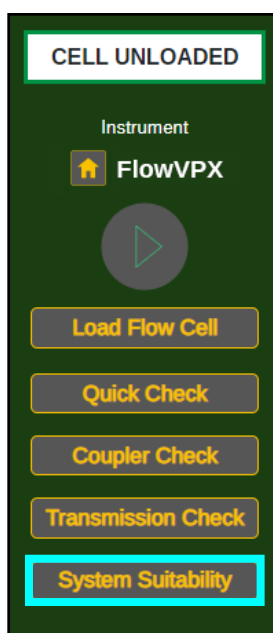
1. Ensure a Flow Cell is loaded before beginning a Quick Check.
2. Open the Quick Kinetics or Validate VPT application. If using Quick Kinetics, open the Validate VPT log by clicking on the Quick Check button in the upper right-hand menu.
3. In the right-hand menu, click on the Quick Check button to open the Quick Check window.
  - **Note:** The Quick Check button will only be usable if a Coupler Check has previously been performed.
4. Follow the on-screen prompts. Click Step Completed to proceed.
5. When prompted, click Continue to begin the Quick Check measurement.
6. Wait while ViPER performs the test.
7. Click Finished once the transmission test(s) are complete.
  - ViPER will display the % Transmission as well as the Pass/Fail result of the test.
  - User has the option to retry the check if the %T value is not within acceptable range.

#### 4.4.4 System Suitability Test

##### FlowVPX System with Cary 60

1. Open the Validate VPT app and click the System Suitability button in the Instrument Controls panel.

Figure 64. System Suitability Button in Instrument Control Menu



2. Click Continue and follow the on-screen prompts. Click Step Completed to proceed.
3. Remove all Fibrette caps. Then, load the Fibrette Optical Component into the FlowVPX System Suitability Adapter (XSA).

- Make sure the tip of the Fibrette Optical Component is clean before inserting.
  - Insert the tip into the XSA Fibrette Holder first, with the threaded end facing up.
 

**Note:** Only use the XSA Fibrette; do not attempt to detach a Fibrette Optical Component that is already connected to a Flow Cell.
4. Attach Fibrette and XSA unit to the FlowVPX Head.
    - Insert the assembled Fibrette and XSA unit into the FlowVPX Head as shown on screen.
    - Ensure that the electrical components on the top of the XSA unit and the bottom of the FlowVPX Head line up with each other.
  5. Tighten the attachment screws on the XSA unit using a 4 mm hex driver to fasten the adapter to the FlowVPX Head.
  6. Click Start Detection. Wait for ViPER software to detect the XSA unit.
    - If not detected, the software will guide you to repeat the previous steps.
  7. Affix the FX connector nut by aligning and tightening on the threaded end of the Fibrette, with the larger-diameter hole facing down (see Figure 67).
  8. Use the 12 in-lbs torque wrench to ensure the FX nut is fully tightened. Tighten with the torque wrench until there is an audible click.
  9. Affix the FC connector nut by aligning and tightening it by hand on the threaded end of the Fibrette, above the FX connector nut.
  10. Load the FlowVPX Detector into the Detector Validation Adapter (DVA) unit.
    - Ensure that the Detector Connector is facing out.
  11. Insert the reference standard into the sample vessel included with the DVA. Fill the vessel at least two-thirds full.
  12. Select the appropriate reference standard from the list and enter the required information (Figure 65).
    - If the reference standard is unknown, complete the Unknown Standard fields.

Figure 65. Reference Standard Information Fields

ConfIRM Standard	CHEM013 Standard	Unknown Standard
Please Input the following	Please Input the following	Please Input the following
Part Number <input type="text"/>	Lot Number <input type="text"/>	Slope Mode <span>Quick</span> <span>Fixed</span>
Lot Number <input type="text"/>	Expected Slope 256 nm <input type="text"/>	Sample Name <input type="text"/>
Expiration Date <input type="text" value="mm/dd/yyyy"/>	260 nm <input type="text"/>	Wavelength <input type="text"/> nm
Slope Target Value <input type="text"/> Abs/mm	280 nm <input type="text"/>	Averaging Time <input type="text" value=".25"/> s
Uncertainty Value <input type="text"/> Abs/mm	310 nm <input type="text"/>	Search Pathlengths <input type="text"/> mm
Repeats <input type="text" value="1"/>	412 nm <input type="text"/>	<input type="text"/> mm
	Expiration Date <input type="text" value="mm/dd/yyyy"/>	<input type="text"/> mm
	Acceptable Variance <input type="text"/> %	Target Absorbance <input type="text"/> Abs
	Repeats <input type="text" value="1"/>	Data Points <input type="text" value="5"/>
		Extinction Coefficient <input type="text"/> ml/(mg*cm)
		Repeats <input type="text" value="1"/>
		Expected Slope <input type="text"/> Abs/mm
		Acceptable Variance <input type="text"/> %

13. Place the loaded sample vessel into the vessel holder. Then, take the vessel holder and place it on the DVA unit.
14. Carefully place the FlowVPX Head assembled with the loaded XSA unit on the DVA.
15. Tighten the two thumbscrews using a 5 mm screwdriver to securely attach the FlowVPX Head and XSA unit to the DVA.
16. Wait for ViPER to search for the Zero Position.
  - If the Zero Position is successfully found, click Continue.
  - If the Zero Position is not located, retry the search.
17. Connect the Delivery Fiber to the FC connector nut. Ensure the key on the Fiber connector lines up with the keyway on the FC nut, then hand-tighten.
  - Ensure the other end of the Delivery Fiber is connected to the Cary 60 spectrophotometer.

18. Connect the Detector Cable to the Detector connector of the FlowVPX Detector.
  - Ensure that the other end of the Detector Cable is connected to the Cary 60 spectrophotometer.
19. Please wait while the transmission check is performed.
  - If the %Transmission is displayed, the check was successful.
  - If the transmission check fails, users are then prompted to retry until a successful %Transmission is read.
20. Once the check is complete, click Continue.
21. Please wait while ViPER runs the reference material.



**CAUTION:** Do not power off or remove any parts of the instruments.

- If a Success message is displayed, it will show the resulting tolerance and slope.
  - If a Retry message is displayed:
    - The software will prompt the user to perform best practice procedures to correct the error.
    - After three failed attempts, the user must change the sample.
22. Click Continue.

#### 4.4.5 Loading the Flow Cell

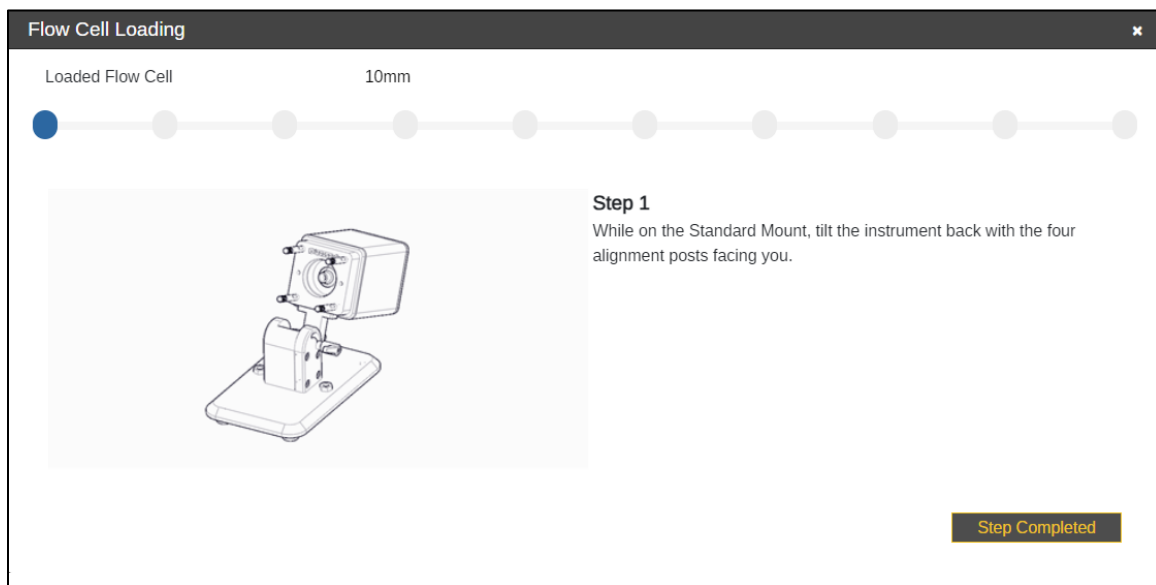
##### FlowVPX System with Cary 60



**CAUTION:** Do not attempt to load the Flow Cell without initiating the loading procedure in the ViPER software. All loading procedure steps must be performed only when prompted by the software. Failure to do so may result in damage to the Flow Cell or FlowVPX Head.

1. Open one of the following applications: Manual Controls, Validate VPT, Quick Kinetics, or Kinetic Survey.
2. Select the Flow Cell size from the drop-down menu at the top of the Method Input menu. In Validate VPT, skip this step.
3. Click the Load button in the Instrument Controls panel. In Validate VPT, click Load Flow Cell.
4. Follow the on-screen instructions. Click Step Completed to proceed to the next step.

Figure 66. Flow Cell Loading Instructions



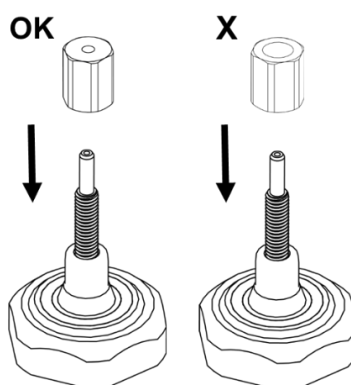
5. With the FlowVPX head on the standard mount, tilt the instrument back so the four alignment posts are facing you.
 

**Note:** If the FlowVPX Head is not being used with the Standard Mount, instead lay the instrument on its side, with the FlowVPX logo facing up.

6. Place a new Flow Cell gasket on top of the Flow Cell. Then insert the Flow Cell, Fibrette Optical Component first, into the FlowVPX Head.
  - Ensure the gasket fits flat on top of the Flow Cell, leaving the Smart Pins uncovered.
  - Ensure the Flow Cell Smart Pins are aligned with the Flow Smart Input on the FlowVPX Head.

**Note:** When using certain Flow Cells, the Alignment Posts will need to be replaced. ViPER software will prompt the user if this replacement is required. For instructions to replace the Alignment Posts, contact Repligen Analytical Support.
7. Place a new Flow Detector gasket on top of the Flow Detector so that the guide holes align.
8. Insert the Flow Cell Detector, glass side first.
9. Secure the Flow Cell and Detector to the FlowVPX Head with the four acorn nuts.
  - Tighten to 40 in-lbs with the provided torque wrench.
  - Tighten the four acorn nuts in a diagonal pattern to equally distribute the torque.
10. Return the FlowVPX assembly to the upright position and ensure the Mounting Post Clamp Handle is tightened.
11. Place and tighten the FX connector nut onto the threaded end of the Fibrette Optical Component, tightening with the larger-diameter hole facing down (see Figure 67).
  - Tighten to 12 in-lbs with the provided torque wrench.

Figure 67. Correct FX Connector Nut Orientation

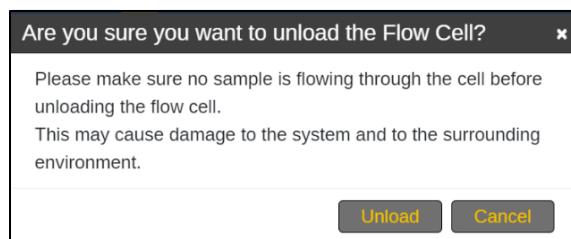


12. Place and securely hand-tighten the FC connector nut above the FX connector nut.
13. Click Start Detection. Wait for ViPER to detect the Flow Cell. The software will indicate “VPX has detected Flow Cell.”
14. Click Step Completed.
15. Click Locate Zero. Wait for the ViPER software to find the Zero Position.
  - If the Zero Position is not found, unload the Flow Cell and restart the procedure from the beginning.
16. Click Next Step.
17. Place the FC end of the Delivery Fiber on the FC connector nut.
  - Line up the key with the keyway and turn clockwise to secure.
18. Connect the right-angle plug of the Detector Cable (EC0196) to the Detector.
  - Ensure the Detector Cable cord is extended upward from the Detector.
19. Click Step Completed.
20. Wait for the Flow Cell Loading Transmission Test Results to appear on the screen.
21. Click OK.

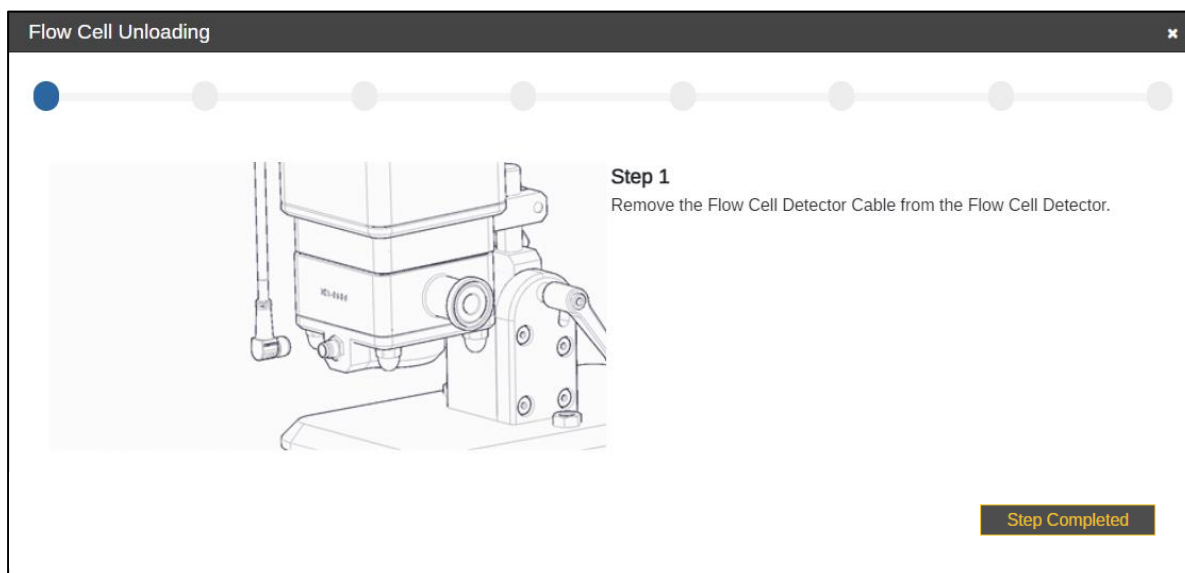
#### 4.4.6 Unloading the Flow Cell

##### FlowVPX System with Cary 60

1. Click the Unload button in the Instrument Controls panel.
2. Ensure that no sample is flowing through the Flow Cell. Then click Unload.

**Figure 68. Unload Flow Cell Confirmation Prompt**

3. Follow the on-screen prompts. Click Step Completed to proceed.

**Figure 69. Flow Cell Unloading Using the Cary 60 Light Source**

4. Remove the Detector Cable (EC0196) from the Detector.
5. Unscrew and disconnect the Delivery Fiber from the Fibrette.
6. Remove the FC connector nut from the Fibrette and set it aside.
7. Remove the FX connector nut from the Fibrette and set it aside.
8. Tilt the FlowVPX back on the Standard Mount so that the bottom of the Detector is facing towards you.
  - Ensure the Mounting Post Clamp Handle is tightened.
9. Unscrew the acorn nuts from the bottom, being careful not to let the Flow Cell Detector tip forward or fall.
  - Loosen the four acorn nuts in a diagonal pattern to equally distribute the torque.
10. Slowly pull the Detector off the FlowVPX Head and place it aside, window up.
11. Remove and discard the Detector gasket.
12. Remove the Flow Cell from the FlowVPX Head.
13. Remove and discard the Flow Cell gasket.
14. Click OK. The Flow Cell has been successfully unloaded.

#### 4.5 FlowVPX with Beams Procedures

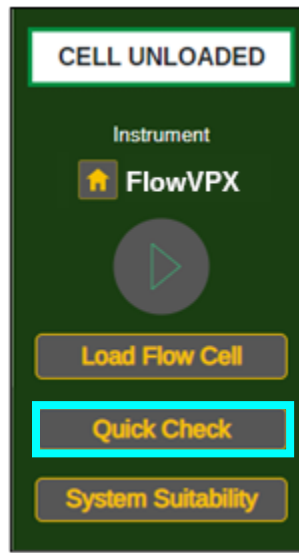
The following procedures involve interaction with the FlowVPX instrument, Beams source and controller, and VIPER software. Please read through and understand the required steps before beginning any procedure in this section.

### 4.5.1 Quick Check

#### FlowVPX System with Beams Source

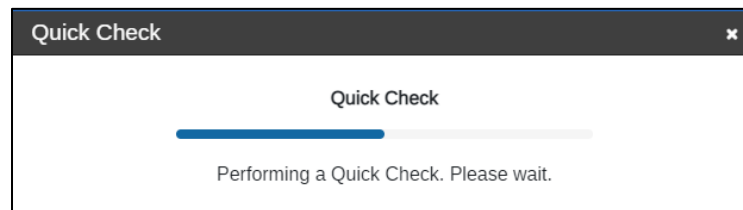
1. Ensure a Flow Cell is loaded before beginning a Quick Check.
2. Open the Quick Kinetics or Validate VPT application. If using Quick Kinetics, open the Validate VPT log by clicking on the Quick Check button in the upper right-hand menu.
3. In the right-hand menu, click on the Quick Check button to open the Quick Check window.

Figure 70. Quick Check Button in Instrument Control Menu



4. Follow the on-screen prompts. Click Step Completed to proceed.
5. When prompted, click Continue to begin the Quick Check measurement.
6. Wait while the system runs the Quick Check test and reports the results.

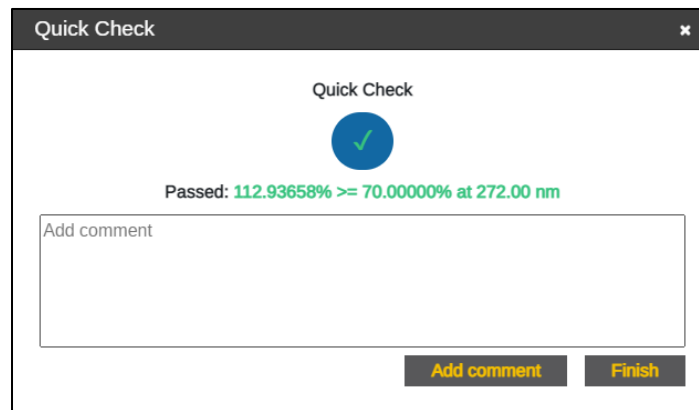
Figure 71. Quick Check Loading Window



7. Confirm the Quick Check ran successfully and that the reported value is higher than 40% transmission.

**Note:** The Quick Check result may be greater than 100%. This value is relative to a reference measurement taken right after the unit's manufacture. A value greater than 100% does not indicate a problem with the unit.

Figure 72. Quick Check Results



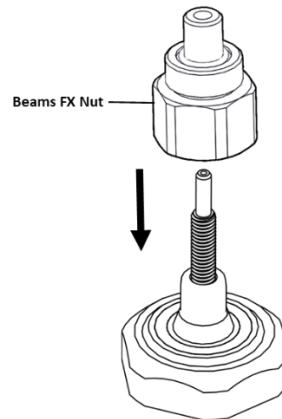
8. To leave a comment, enter the desired comment in the field provided and click Add comment.
9. Click Finish.

#### 4.5.2 System Suitability Test

##### FlowVPX System with Beams Source

1. Open the Validate VPT app and click the System Suitability button in the Instrument Controls panel.
2. Click Continue and follow the on-screen prompts. Click Step Completed to proceed.
3. Load the Fibrette Optical Component into the FlowVPX System Suitability Adapter (XSA) unit.
  - Make sure the tip of the Fibrette Optical Component is clean before inserting.
  - Remove all Fibrette caps prior to insertion.
  - Insert the tip into the XSA Fibrette Holder first, with the threaded end facing up.  
**Note:** Only use the XSA Fibrette; do not attempt to detach a Fibrette Optical Component that is already connected to a Flow Cell.
4. Attach to the FlowVPX Head.
  - Insert the assembled Fibrette and XSA unit into the FlowVPX Head as shown on screen.
  - Ensure that the electrical components on the top of the XSA unit and the bottom of the FlowVPX Head line up with each other.
5. Tighten the VPX Attachment screws on the XSA unit.
  - Using a 4 mm hex driver, tighten the screws on the System Suitability Adapter to the FlowVPX Head.
6. Affix the Beams FX connector nut by aligning and tightening on the threaded end of the Fibrette Optical Component (see Figure 73).
  - Use the 12 in-lbs torque wrench to ensure the nut is fully tightened.
  - Tighten with the torque wrench until there is an audible click.

Figure 73. Correct Beams FX connector Nut Orientation



7. Wait while ViPER detects the XSA unit. Click Continue when “XSA detected successfully” appears on screen.
  - If not detected, the software will guide you to repeat the previous steps.
8. Load the FlowVPX Detector into the Detector Validation Adapter (DVA) unit. Ensure that the Detector Connector is facing out.
9. Insert the reference standard into the sample vessel included with the DVA. Fill the vessel at least two-thirds full.
10. Select the appropriate reference standard from the list and enter the required information.
  - If the reference standard is unknown, complete the Unknown Standard fields.
11. Place the loaded sample into the vessel holder. Then take the vessel holder and place it on the DVA unit.
12. Carefully place the FlowVPX Head assembled with the loaded XSA unit on the DVA.
13. Tighten the two thumbscrews using a 5 mm screwdriver to securely attach the FlowVPX Head and XSA unit to the DVA.
14. Wait while ViPER searches for the Zero Position.
  - If the Zero Position is successfully found, click Continue.
  - If the Zero Position is not located, retry the search.
15. Place the Beams Source on top of the tightened Beams FX connector nut and hand-tighten the locking ring at the base of the Beams Source.
16. Connect the yellow end of the Beams Source cable to the labeled position on the Beams controller.
17. Please wait while a Quick Check is performed.
  - ViPER will display the % Transmission as well as the Pass/Fail result.
  - If the Quick Check fails, the user has the option to retry until a successful %Transmission is read.
18. Once the check is complete, click Continue.



**CAUTION:** Do not power off or remove any parts of the instruments.

19. Please wait while ViPER runs the reference material.
  - If a Success message is displayed, it will show the resulting tolerance and slope.
  - If a Retry message is displayed:
    - The software will prompt the user to perform best practice procedures to correct the error.
    - After three failed attempts, the user must change the sample.
20. Click Continue.



### 4.5.3 Loading the Flow Cell

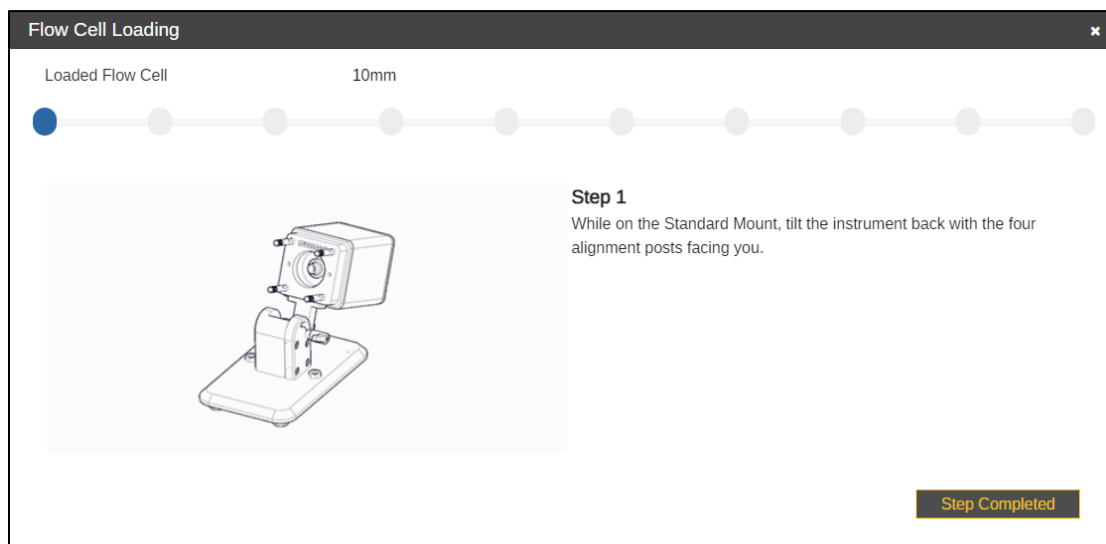
#### FlowVPX System with Beams Source



**CAUTION:** Do not attempt to load the Flow Cell without initiating the loading procedure in the ViPER software. All loading procedure steps must be performed only when prompted by the software. Failure to do so may result in damage to the Flow Cell or FlowVPX Head.

1. Open one of the following applications: Manual Controls, Validate VPT, Quick Kinetics, or Kinetic Survey.
2. Select the Flow Cell size from the drop-down menu at the top of the Method Input menu. In Validate VPT, skip this step.
3. Click the Load button in the Instrument Controls panel. In Validate VPT, click Load Flow Cell.
4. Follow the on-screen instructions. Click Step Completed to proceed to the next step.

Figure 74. Flow Cell Loading Instructions



5. With the FlowVPX Head on the standard mount, tilt the instrument back so the four alignment posts are facing you.
 

**Note:** If the FlowVPX Head is not being used with the Standard Mount, instead lay the instrument on its side, with the FlowVPX logo facing up.
6. Place a new Flow Cell gasket on top of the Flow Cell. Then insert the Flow Cell, Fibrette Optical Component first, into the FlowVPX Head.
  - Ensure the gasket fits flat on top of the Flow Cell, leaving the Smart Pins uncovered.
  - Ensure the Flow Cell Smart Pins are aligned with the Flow Smart Input on the FlowVPX Head.

**Note:** When using certain Flow Cells, the Alignment Posts will need to be replaced. ViPER software will prompt the user if this replacement is required. For instructions to replace the Alignment Posts, contact Repligen Analytical Support.
7. Place a new Flow Detector gasket on top of the Flow Detector so that the guide holes align.
8. Insert the Flow Cell Detector, glass side first.
9. Secure the Flow Cell and Detector to the FlowVPX Head with the four acorn nuts.
  - Tighten to 40 in-lbs with the provided torque wrench.
  - Tighten the four acorn nuts in a diagonal pattern to equally distribute the torque.
10. Orient the FlowVPX Head in an upright position and ensure the Mounting Post Clamp Handle is tightened.
11. Place and hand-tighten the Beams FX Nut onto the threaded end of the Fibrette Optical Component, located on top of the FlowVPX unit (see Figure 73).
  - Tighten to 12 in-lbs with the provided torque wrench until there is an audible click.
12. Click Start Detection. Wait for ViPER to detect the Flow Cell. The software will indicate “VPX has detected Flow Cell.”
13. Click Step Completed.
14. Connect the yellow end of the Beams Source cable to the labeled position on the Beams controller.

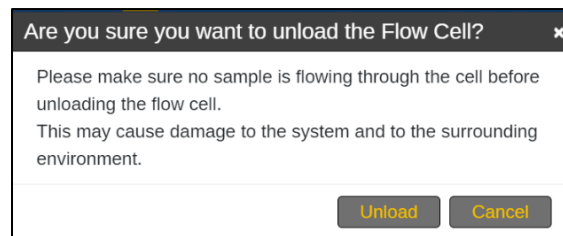
15. Place the Beams light source on top of the tightened FX connector nut and hand-tighten the locking ring at the base of the Beams source.
16. Click Locate Zero.
17. Wait for ViPER to find the Zero Position.
  - If the Zero Position is not found, unload the Flow Cell and restart the procedure from the beginning.
18. Click Next Step.
19. Connect the right-angle plug of the Beams Detector Cable (EC0328) to the Detector. Ensure the Detector Cable cord is extended upwards from the detector.
20. Click Step Completed.
21. Wait for the Flow Cell Loading Transmission Test Results to appear on the screen.
22. Click OK.

#### 4.5.4 Unloading the Flow Cell

##### FlowVPX System with Beams Source

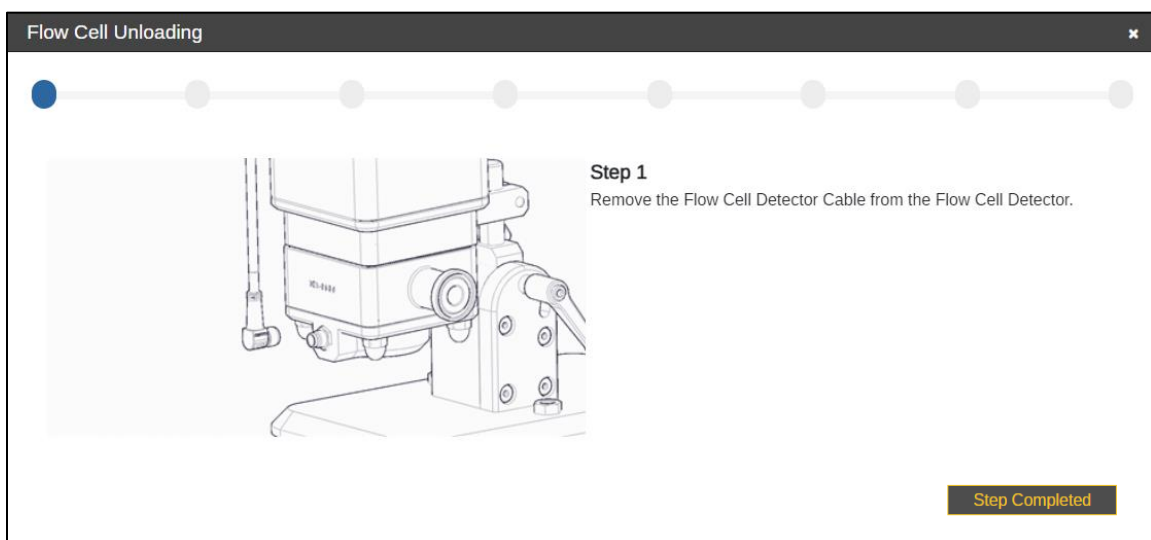
1. Click the Unload button in the Instrument Control menu.
2. Ensure that no sample is flowing through the Flow Cell. Then click Unload.

**Figure 75. Unload Flow Cell Confirmation Prompt**



3. Follow the on-screen prompts. Click Step Completed to proceed.

**Figure 76. Flow Cell Unloading Using the Beams Light Source**



4. Remove the Beams Detector Cable (EC0328) from the Detector.
5. Unscrew and disconnect the Beams light source from the Fibrette Optical Component.
6. Remove the Beams FX connector nut from the Fibrette and set it aside.
7. Tilt the FlowVPX back on the Standard Mount so that the bottom of the Detector is facing towards you.

- Ensure the Mounting Post Clamp Handle is tightened.
8. Unscrew the acorn nuts from the bottom, being careful not to let the Flow Cell Detector tip forward or fall.
    - Set the acorn nuts aside.
  9. Slowly pull the Detector off the FlowVPX Head and place it aside, window up.
    - Remove and discard the Detector gasket.
  8. Remove the Flow Cell from the FlowVPX Head.
    - Remove and discard the Flow Cell gasket.
  8. The Flow Cell has been successfully unloaded.
  9. Click OK.

## 5. Admin Settings

The Admin Settings menu is where users can manage devices, system configurations, and application default settings. Only users who have the Admin ViPER role can view and modify Admin settings.

The following sections describe the settings that are available to view and modify.

### 5.1 Devices

This section contains two tabs: Device Settings and Display Settings. In either tab, click Modify in the upper-right corner to change settings. Click Apply in the upper-right corner to save changes. Upon clicking Apply, the user will be prompted to enter their username, password, and reason for changing the settings.

#### Device Settings

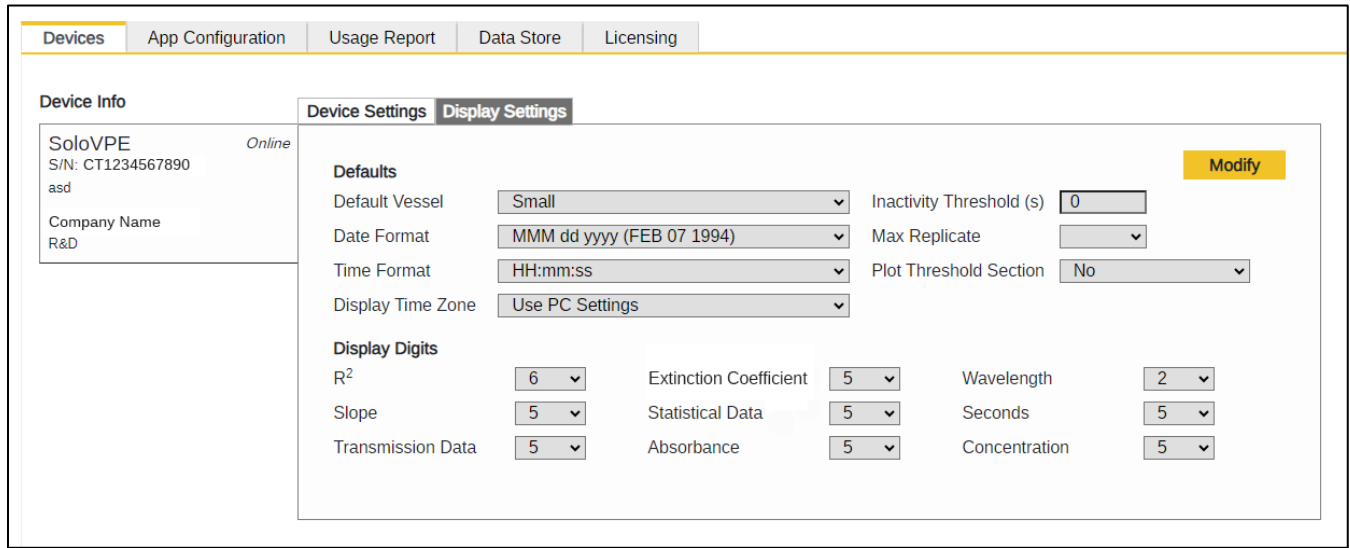
- **Zero Setting (SoloVPE only):** This field contains the total number of steps the motor travels from the Home (fully raised) position to the Zero Pathlength position. At Zero Pathlength, the tip of the Fibrette Optical Component should be just touching the bottom of the sample vessel.
- **Min. Step Size:** The minimum step size that can be selected for pathlength adjustment in ViPER applications.
- **Device Name:** The user may enter an identifier for the VPT device.
- **Building:** The user may enter the name of the building where the device is located.
- **Lab/Room:** The user may enter the name or number of the lab or room where the device is located.
- **Cary Reboot Reminder:** When toggled on, the system will notify the user to restart the Cary 60 every 7 days.

Figure 77. Device Settings

#### Display Settings

- **Default Vessel (SoloVPE only):** Set the default sample vessel size.
- **Date Format:** Sets the date format in reports. The user can choose the order of the month, day, and year, as well as choose whether each is separated by a space, slash, hyphen, or period.
- **Time Format:** Sets the time format in reports. The user can choose between *HH:mm:ss* and *HH:mm*.
- **Display Time Zone:** Sets the time of day. The user can choose between the time zone of the PC or Default (UTC).
- **Inactivity Threshold:** Sets the time limit, in seconds, of inactivity before the user is automatically logged out.
- **Max Replicate (SoloVPE only):** Sets the maximum number of replicate measurements allowed. The user can select from 2 to 12 reps.
- **Plot Threshold Section (SoloVPE only):** When set to Yes, the search pathlength in Quick Slope mode will be displayed.
- **Display Digits:** Sets the number of decimal places shown for each of the parameters listed.

Figure 78. Display Settings

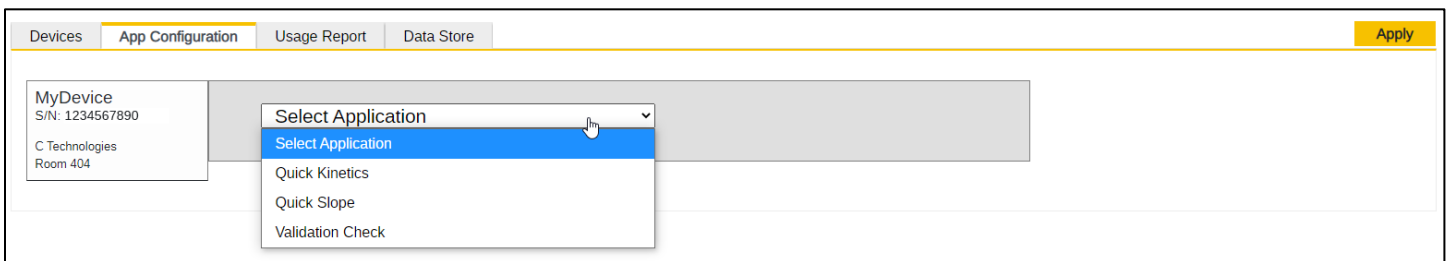


### 5.2 App Configuration

Default configurations for each application are accessible here. Each application has a unique set of parameters.

Choose an application from the drop-down menu, then click Modify in the upper-right corner to change settings. Click Apply in the upper-right corner to save changes. Upon clicking Apply, the user will be prompted to enter their username, password, and reason for changing the settings.

Figure 79. App Configuration

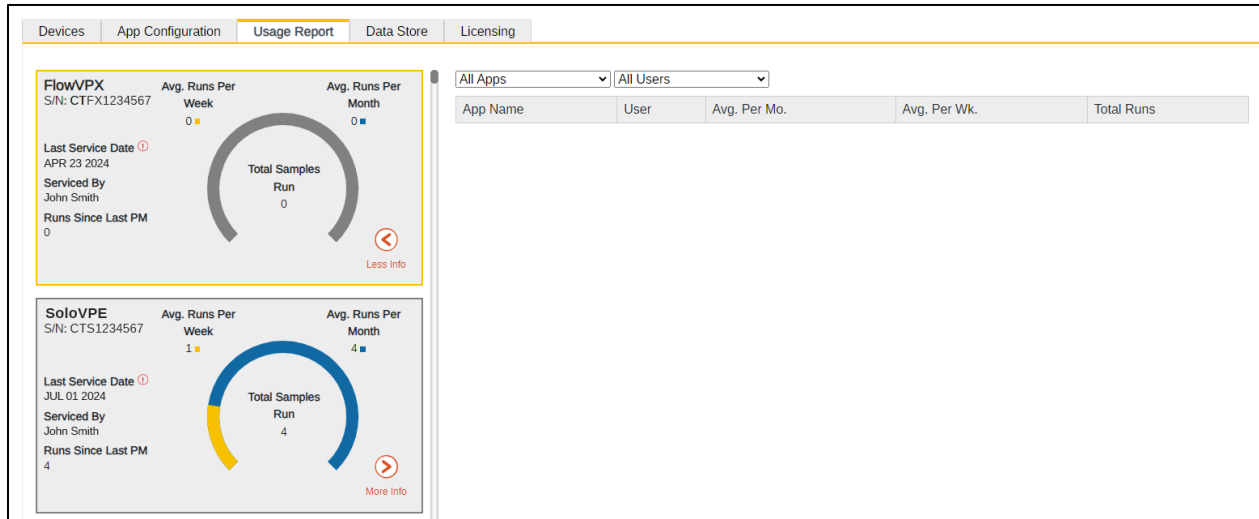


### 5.3 Usage Report

This section displays usage data for each device. The data can be filtered by application and/or user. The report displays the following information:

- Device Name
- Serial Number
- Last Service Date
- Serviced By
- Runs Since last PM
- Average Runs per Week
- Average Runs per Month
- Total Sample Runs

Figure 80. Usage Report



### 5.4 Data Store

This section displays information about where data will be stored. These settings are preconfigured by Repligen with the exception of Authentication Type.

The Authentication Type determines how users log in:

- **LDAP:** Network authentication. ViPER Software checks user credentials against an active directory server.
- **VIPER:** Local authentication. User credentials are stored on the device running ViPER Software.

Figure 81. Data Store

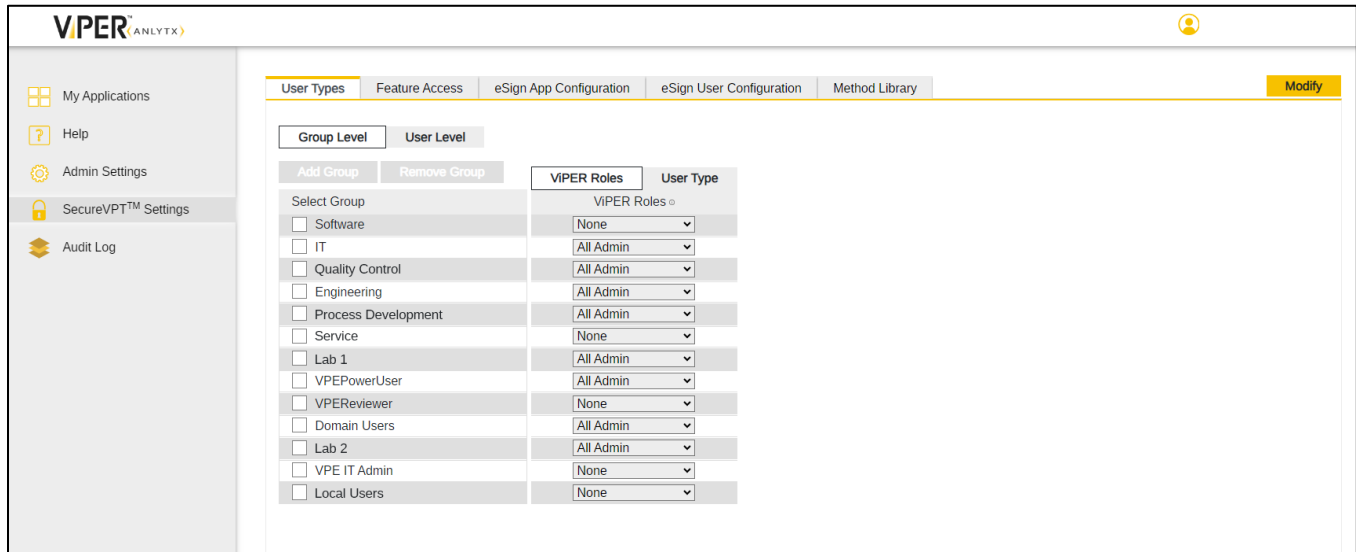
The screenshot shows the 'Data Store' configuration page. It includes the following fields and options:

- Database Type:
- Server Name:
- Database Name:
- UserName:
- Password:
- Authentication Type:
- Submit:

## 6. SecureVPT™ Settings

SecureVPT™ is an optional package within the ViPER software designed to enable users to achieve compliance with 21 CFR Part 11. Access to this feature requires a separate purchase and license. The configuration settings for the SecureVPT add-on will only be visible to users who have the SecureVPT Admin or All Admin roles in ViPER.

Figure 82. SecureVPT Settings Menu: User Types



Admin users can assign user roles and feature access of available applications for a particular group or user. Admins can also use these security measures to dictate how eSignatures are initiated and managed during specific software events. The settings that can be modified are described below.

### 6.1 User Types

Assign ViPER roles and User Types for each user by Group Level and/or User Level. Group Level allows the user to apply ViPER roles and User Types to an entire group. User Level allows the user to apply ViPER roles and User Types to specific users within existing groups.

For suggested user access levels, see the following articles:

- [KB21003 CTech™ ViPER™ and SecureVPT™ Software for SoloVPE® System: Suggested User Access Level Table](#)
- [KB23002 CTech™ ViPER™ and SecureVPT™ Software for FlowVPX® System: Suggested User Access Level Table](#)

#### ViPER Roles

- ViPER Admin
- SecureVPT Admin
- All Admin
- None

#### User Types

- Full Control
- Data Acquisition
- Data Review
- None

### How to add a group

1. Click Modify.
2. Click Add Group.
3. Enter Group Name, then click Add.
4. *(Admin required)* Enter password for the username displayed.
5. Enter reason for adding the group.
6. Click Save Changes.
7. Click Apply.
8. Click OK when the Success window appears.

### How to remove a group

1. Click Modify.
2. Click the checkbox to select one or more groups to remove.
3. Click Remove Group.
4. *(Admin required)* Enter password for the username displayed.
5. Enter reason for removing the group.
6. Click Save Changes.
7. Click Apply.
8. Click OK when the Success window appears.

### How to assign group permissions

1. Click the checkbox to select one or more groups.
2. Assign a ViPER role for users in each group.
3. Assign a User Type to users in each group for each application.
4. Click Apply.
5. Complete Administrator Action Required.
6. Click Apply.

## 6.2 User Management

This menu is only available when the authentication type is set to ViPER (local authentication). The User Management feature allows one to add, deactivate, or reactivate a user. The admin can also reset a user's password, add a user to a group, or remove a user from a group.

### How to add a user

1. Click Modify.
2. Click Add User.
3. Enter the new user's information in the Add New User window. All fields with an asterisk must be filled in.
  - Leave the password field blank; the user will create a password when they first log in.
  - The user can be added to a preexisting group. (Groups are created in the User Types section of SecureVPT Settings).
4. Click Add.
5. When the Administrator Action Required window appears, enter the password for the username shown and a reason for adding the new user.
6. Click Save Changes.
7. Click OK in the Success window.

### How to deactivate a user, reactivate a user, or reset a user's password

1. Click Modify.
2. Select the entry associated with the user.
3. Click the desired action: Deactivate User, Reactivate User, or Reset Password.



4. Click Yes to confirm.
5. When the Administrator Action Required window appears, enter the password for the username shown and a reason for the action being performed.
6. Click Save Changes.
7. Click OK in the Success window.

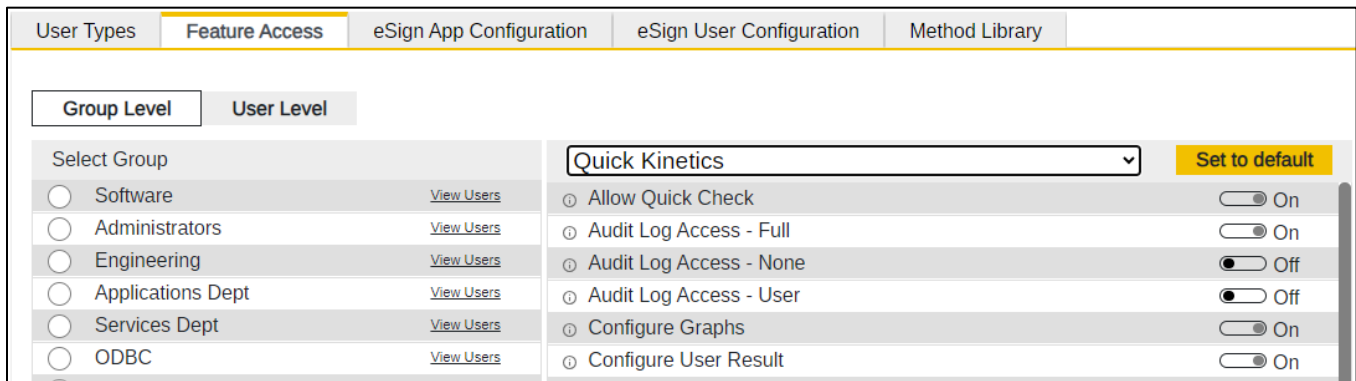
### 6.3 Feature Access

Every application has a unique set of features; users can toggle features on or off in this menu. Features that are toggled off will appear in the application as either hidden or disabled. Click Modify in the upper-right corner to change settings. To save changes, click Apply in the upper-right corner.

Features settings that are modified here are specific to the application selected in the drop-down menu. Changes will not affect the entire ViPER platform.

Changes can be applied by Group Level or User Level.

Figure 83. Feature Access



### 6.4 eSign App Configurations

For each application, Admins can assign eSign points, or instances when an eSignature will be required, and the types of eSignatures required at each point.

#### eSign Roles:

- **Author:** the user that initiated an action
- **Reviewer:** the user that reviewed the action
- **Approver:** the user that provides a final signature after the action has gone through review

Figure 84. eSign App Configuration

User Types	Feature Access	eSign App Configuration	eSign User Configuration	Method Library
Quick Slope				
Data Collecting	Select All <input type="checkbox"/>	Author▼	Reviewer▼	Approver▼
Start of Data Collect		<input checked="" type="checkbox"/>	<input checked="" type="checkbox"/>	<input checked="" type="checkbox"/>
End of Data Collect		<input type="checkbox"/>	<input type="checkbox"/>	<input type="checkbox"/>
Stop of Data Collect		<input type="checkbox"/>	<input type="checkbox"/>	<input type="checkbox"/>
End of Baseline Collect		<input type="checkbox"/>	<input type="checkbox"/>	<input type="checkbox"/>
Methods	Select All <input type="checkbox"/>	Author▼	Reviewer▼	Approver▼
Save a Method		<input type="checkbox"/>	<input type="checkbox"/>	<input type="checkbox"/>
Reports	Select All <input type="checkbox"/>	Author▼	Reviewer▼	Approver▼
Save a Report		<input type="checkbox"/>	<input type="checkbox"/>	<input type="checkbox"/>

### 6.5 eSign User Configurations

Admins can assign eSign roles for Groups or individual users.

#### eSign Roles:

- **Author:** the user that initiated an action
- **Reviewer:** the user that reviewed the action
- **Approver:** the user that provides a final signature after the action has gone through review
- **Override:** In the instance of failing an eSignature, this role ensures the action is noted to have failed the approval process.

Figure 85. eSign User Configuration

User Types	Feature Access	eSign App Configuration	eSign User Configuration	Method Library	Modify
Quick Survey					
Select Group	Select User	Author	Reviewer	Approver	Override
<input checked="" type="checkbox"/> Software <a href="#">View Users</a>	<input checked="" type="checkbox"/> ADMIN <small>Software</small>	<input checked="" type="checkbox"/>	<input checked="" type="checkbox"/>	<input checked="" type="checkbox"/>	<input type="checkbox"/>
<input type="checkbox"/> Administrators <a href="#">View Users</a>	<input checked="" type="checkbox"/> TSTARK <small>Software</small>	<input type="checkbox"/>	<input type="checkbox"/>	<input type="checkbox"/>	<input type="checkbox"/>

### 6.6 Method Library

The Method Library shows all methods that have been saved from within VIPER applications, including the method name, creator, date and time saved, and date and time of the last run.

To archive a method, click Modify in the upper-right corner, click on the method in the table, and click Archive Method at the bottom of the window that appears.

Figure 86. Method Library

User Types	Feature Access	eSign App Configuration	eSign User Configuration	Method Library	Modify
Kinetic Survey					
Name	Created By	Saved Time Stamp (UTC)	Last Run Time Stamp (UTC)		
2024-04-26 Sample 1	JSmith	APR 26 2024 14:14:17	MAY 10 2024 16:42:37		
Test Method 1	JSmith	MAR 13 2024 19:23:33	MAR 13 2024 19:23:38		
Test Method 2	JDoe	JUN 27 2023 15:58:25	OCT 30 2023 15:00:29		

## 7. Audit Log

The Audit Log shows all the securely logged data and activity. Users who have the Admin role will be able to see all users' activity; other users will see only their own individual user audit log.

Columns can be shown or hidden by clicking Columns in the upper-right corner. Data can be filtered by user, device, application, event type, and date.

The audit log can be exported as a PDF by clicking Export in the upper-right corner. The exported PDF will reflect the filters currently applied to the table.

## 8. Advanced

This chapter contains information regarding integration and communication with external servers.

### 8.1 LDAP Configuration

Lightweight Directory Access Protocol (LDAP) is an open and cross-platform protocol used for directory services authentication. LDAP provides the communication language that applications use to communicate with other directory services servers.

When ViPER is set to LDAP authentication, users log in using their credentials from the associated Active Directory network.

### 8.2 SQL Server Database Architecture

SQL Server is a relational database management system developed by Microsoft. As a database server, it is a software product with the primary function of storing and retrieving data requested by other software applications, which may run either on the same computer or another computer across a network.

For comprehensive guidance on managing the SQL Server database, please see [KB23003 Data Management for ViPER ANLYTX](#).

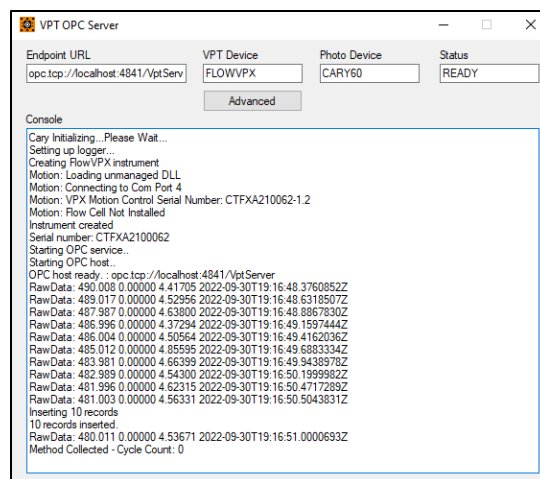
### 8.3 VPT OPC Server

VPT OPC Server is a program that translates the hardware communication protocol used by a programmable logic controller (PLC) into the OPC protocol. The OPC client software is a program that connects to the hardware, such as a human-machine interface (HMI). The OPC client communicates with the OPC server to receive data or send commands to the hardware.

VPT OPC Server must be running in order to operate ViPER software and the VPT instrument. Do not close this application while using the ViPER software.

For more information, please see [KB20006 ViPER/OPC Server Integration](#).

Figure 87. VPT OPC Server



## 9. Best Practices & Troubleshooting

This chapter contains recommended actions and procedures for using ViPER ANALYTIX Software.

### 9.1 Backing Up Data

This section explains the critical aspects of backing up the VPTData SQL database to ensure the safety and accessibility of your information.

#### Performing a Full Backup

There are two common methods to perform a full backup:

- A. Use the ViPER backup program. For more information on this program, please see [KB22002 CTech™ ViPER® ANALYTIX Software SQL Server Backup Procedure](#).
- B. Use the backup capabilities of Microsoft SQL Server Management Studio:
  1. Launch SQL Server Management Studio (SSMS) and connect to the database server with the proper credentials. If you do not know the proper credentials, please contact Repligen at [analytics-support@repligen.com](mailto:analytics-support@repligen.com).
  2. Navigate to the Object Explorer and locate the Databases node.
  3. Right-click on the VPTData database and select Tasks, followed by “Back Up...”
  4. In the Back Up Database window, select Backup type: Full.
  5. Specify the destination for the backup file and provide a meaningful name.
  6. Review the settings and click OK to initiate the backup process. This will create a .BAK file in the location specified in the previous step.

#### Automated Backups

To ensure consistent backups, it is possible to automate backups using one of two methods:

- A. Use the ViPER backup program. For more information on this program, please see [KB22002 CTech™ ViPER® ANALYTIX Software SQL Server Backup Procedure](#). Note that this will only create .bak files on the local PC. It is advised to copy these files to a secure location such as a network drive.
- B. Create a scheduler to perform automated backups at regular intervals:
  1. Create a backup script:
    - 1.1. Open a text editor (e.g., Notepad) and create a backup script. The script should include an SQLCMD command to perform a full backup of the VPTData database, for example:

```
sqlcmd -S ServerName\InstanceName -U Username -P Password -Q "BACKUP DATABASE [VPTData] TO DISK = N'C:\BACKUP\VPTData.bak'"
```
    - 1.2. Save the document with a .bat extension.
  2. Set up Windows Task Scheduler:
    - 2.1. Open Windows Task Scheduler.
    - 2.2. Create a new task and specify a name and description.
    - 2.3. In the Triggers tab, set the schedule (e.g., daily, weekly) for the automated backup.
    - 2.4. In the Actions tab, create a new action and select the .bat file saved in step 1.2 as the program to run.
  3. Configure security credentials:
    - 3.1. Ensure the account running the task has the necessary permissions to access and back up the VPTData database.

For instructions on restoring and migrating the VPTData database, please see [KB23003 Data Management for ViPER ANALYTIX](#).

### 9.2 Frequently Asked Questions

#### Q: What is the difference between VPT OPC Server and ViPER software?

A: VPT OPC Server, also known as VPT Core, is a communication hub that links the VPT instrument, database, and user interface through an OPC-UA server. ViPER is the primary user interface, which facilitates interactions with the instrument and database.

**Q: What programs are necessary for ViPER to run?**

A: The ViPER application (ViPER.exe) requires the VPTCore application (VptOpcServerForm.exe), Chrome web browser (Chrome.exe), and SQL Server. If using the Cary 60 light source, Cary WinUV is also required.

**Q: Do I need Internet to run ViPER?**

A: No. The software uses the web browser interface but does not require Internet to run.

**Q: Why does the software need to run in Chrome?**

A: The software is built as a Chromium browser application. Chrome serves as the primary testing platform, ensuring optimal performance and compatibility. Other browsers are not qualified for use.

**Q: What are ViPER Certificates for Chrome?**

A: ViPER certificates establish trust between Chrome and the ViPER software. This leverages Chrome's certificate management system alongside OPC-UA certificates, guaranteeing secure and reliable connections between the browser, VPTCore, and ViPER.

**Q: What is the difference between the Save and Export functions?**

A: The Save function stores data directly into the database, accessible through the ViPER interface for future use. The Export function enables users to store data and reports in various formats such as PDF or CSV, allowing sharing and analysis outside of the software environment.

**Q: Where are files saved when I click Save?**

A: When you click Save, the software updates specific rows in the SQL database rather than saving flat files locally. This allows the data to be accessed and updated within the ViPER software interface whenever necessary.

**Q: Where are files saved when I click Export?**

A: When you click Export, the exported files are typically saved to your default downloads location, as configured in your Chrome browser settings. Administrators can modify this location within Chrome according to their preferences.

**Q: How do I change Report configurations?**

A: Report configurations can be set using the Report Wizard. See section 4.1.

**Q: What do I do when my samples are out of tolerance?**

A: First, ensure that you are following all Best Practices recommended in the following references:

- [DOC0153 CTech™ SoloVPE® System: Best Practices](#)
- [DOC0277 CTech™ FlowVPX® System with Cary 60: Best Practices](#)
- [DOC0308 CTech™ FlowVPX® & Beams Systems: Best Practices](#)

If samples continue to be out of tolerance, reach out to [analytics-support@repligen.com](mailto:analytics-support@repligen.com).

**Q: What tests are recommended to verify system performance?**

A: Run a Quick Check followed by a System Suitability Test.

**Q: How do I run a System Suitability Test / Quick Check / Coupler Check?**

A: These tests can be initiated in the Validate VPT app, Quick Slope app (SoloVPE), or Quick Kinetics app (FlowVPX).

**Q: What do ViPER Roles and User Types mean?**

A: ViPER Roles designate specific administrative functions, such as accessing the Admin page and managing SecureVPT. User Types are broad roles, assigned by administrators, within particular applications. See Chapter 6 for details.

**Q: How can I connect my computer to the network to enable LDAP authentication?**

A: To enable LDAP authentication, ensure that your computer is integrated into your domain network. Your IT department can assist with this. Additionally, a default Administrators group should be configured prior to enabling LDAP authentication. Once these are fulfilled, navigate to Admin Settings > Data Store and change the Authentication Type to LDAP.

**Q: How do I configure eSignatures?**

A: eSignatures can be configured in the SecureVPT Settings. See Chapter 6 for details.

**9.3 Troubleshooting**

Issue	Recommended Action(s)
Error appears upon startup	<ul style="list-style-type: none"> <li>Follow specific instructions accompanying the error message.</li> <li>Ensure the USB connection between the computer and Cary 60 or Beams Controller is secure.</li> <li>Ensure the USB connection between the computer and VPT instrument is secure.</li> </ul>
User cannot log in	<ul style="list-style-type: none"> <li>Verify account information with a ViPER Administrator account.</li> <li>Ensure the correct username and password have been entered.</li> <li>If using LDAP Authentication, confirm that the account is part of a domain group with access to the software.</li> <li>If the issue persists, please contact Analytics Support.</li> </ul>
VPT OPC Server does not start	<ul style="list-style-type: none"> <li>Attempt to start the VPT OPC Server application manually from: C:\Program Files (x86)\CTech\ViPER\OPC\VptOpcServerForm.exe</li> <li>If the application does not start, note any error messages or issues in the Event Viewer application. Send the error messages, along with any relevant screenshots or images, to Analytics Support for further assistance.</li> </ul>
Error appears upon loading Flow Cell	<p><b>Flow Cell Not Detected</b></p> <ul style="list-style-type: none"> <li>Clean the Smart Pins using a lint-free wipe and isopropyl alcohol (IPA). Ensure the pins can be gently pushed down and spring back when released.</li> <li>Use a new, clean spot on the lint-free wipe with IPA to wipe the contact pads on the FlowVPX System.</li> </ul> <p><b>Flow Cell Zeroing Unsuccessful</b></p> <ul style="list-style-type: none"> <li>On the first failure, try again.</li> <li>On the second failure, contact Analytics Support.</li> </ul> <p><b>Transmission Test Failed</b></p> <ul style="list-style-type: none"> <li>Clean the end of the Delivery Fiber and the Flow Fibrette using a lint-free wipe and compressed air.</li> <li>Clean the Flow Cell window and the Detector Module window using a lint-free wipe and IPA.</li> <li>For Stainless Steel Flow Cells only, flush the Flow Cell with 0.1 M NaOH followed by deionized (DI) or water for injection (WFI).</li> <li>If the Transmission Test still fails, contact Repligen's Analytics Support.</li> </ul>
Unexpected feature access	<ul style="list-style-type: none"> <li>Check the ViPER Roles and User Types to ensure correct permissions.</li> <li>Verify SecureVPT access to the appropriate application.</li> <li>Ensure the account is not part of any conflicting groups.</li> <li>If the issue persists, please contact Analytics Support.</li> </ul>
ViPER Software is in 'Read-Only' Mode	<ul style="list-style-type: none"> <li>Ensure the VPT OPC Server application is running without errors.</li> <li>Verify the USB connection between the computer and Cary 60 or Beams Controller is secure.</li> <li>Check the USB connection between the computer and the VPT instrument to ensure it is secure.</li> </ul>

For help with any other issues, please contact [analytics-support@repligen.com](mailto:analytics-support@repligen.com) and include the serial number of your system, a detailed description of your issue, any relevant attachments, and any troubleshooting steps already attempted.

**9.4 Additional Resources**

Explore the links below for information regarding ViPER software and related topics.

**Repligen Website**

[CTech ViPER ANLYTX Software](#)

[Repligen Knowledge Base](#)

**User Guides**

[DOC0228 CTech™ SoloVPE® User Guide](#)

[DOC0211 CTech™ FlowVPX® User Guide](#)

**Best Practices**

[DOC0153 CTech™ SoloVPE® System: Best Practices](#)

[DOC0277 CTech™ FlowVPX® System with Cary 60: Best Practices](#)

[DOC0308 CTech™ FlowVPX® and Beams™ Systems: Best Practices](#)

**Knowledge Base Articles**

[KB21003 CTech™ ViPER™ and SecureVPT™ Software for SoloVPE® System: Suggested User Access Level Table](#)

[KB23002 CTech™ ViPER™ and SecureVPT™ Software for FlowVPX® System Suggested User Access Level Table](#)

[KB22002 CTech™ ViPER® ANLYTX Software SQL Server Backup Procedure](#)

[KB23003 Data Management for ViPER ANLYTX](#)

[KB20006 ViPER/OPC Server Integration](#)

**White Papers**

[DOC0198 ViPER ANLYTX 21 CFR Part 11 & Annex 11 Compliance Position White Paper](#)



---

## Glossary

**21 CFR Part 11:** The part of Title 21 of the Code of Federal Regulations that establishes the United States Food and Drug Administration (FDA) regulations on electronic records and electronic signatures. Part 11, as it is commonly called, defines the criteria under which electronic records and electronic signatures are considered trustworthy, reliable, and equivalent to paper records.

**Absorbance:** A measure of total transmitted light that is lost or consumed by the solution being measured. Total absorbance contains the percent of light lost due to scatter as well and must be corrected depending on the composition of the solution through which absorbance is being measured. This is also represented as the product of absorptivity (extinction coefficient), pathlength, and concentration, written as  $A = \epsilon lc$ .

**Absorbance Plateau:** Generally obtained by taking a slice from a variable pathlength surface, this is a 2-dimensional data set created from pathlength versus wavelength data at a specific (constant) absorbance level.

**Absorbance Unit (AU):** A logarithmic unit indicating the level of light attenuation due to absorption within a sample. 1 AU is equivalent to 10% transmission, while 2 AU is equivalent to 1% transmission.

**Averaging Time:** The Cary spectrophotometer setting that configures how long the system will collect data at each wavelength. Able to be configured in seconds, this number corresponds to many pulses of the Xenon flash lamp. One pulse corresponds to 1/80 of a second or 0.0125 seconds; therefore, each second is 80 pulses of the lamp.

**Baseline Measurement:** An initial measurement taken prior to enacting changes on a process and used to evaluate results of those changes over time; the basis against which change is measured.

**Beer-Lambert law (Beer's law):** The law of physics that describes the proportional relationship between absorbance, pathlength, and concentration. Represented by  $A = \epsilon lc$ , where  $A$  is the absorbance,  $\epsilon$  is the extinction coefficient,  $l$  is the pathlength, and  $c$  is the concentration.

**Concentration:** The amount of analyte in a given volume of sample—for spectroscopy, this is in moles per liter or mass per unit volume.

**Correlation (statistical):** A measure of the relationship or dependence between two data sets of variables. See also *R<sup>2</sup> Value*.

**Cycle Count:** The number of quick slope measurements or fixed slope measurement sequences that the system has completed.

**Database:** A compilation of all data stored from VPT System testing when data is configured to be exported.

**Delta Concentration:** The rate of change in the concentration of the sample.

**Delta Moving Average Concentration:** The rate of change of the moving averages.

**Delta Time:** The interval of time between data point collection.

**Extinction Coefficient (EC):** An intrinsic property of a substance, described by a numerical value that quantifies the propensity of a substance to absorb electromagnetic radiation at a specific wavelength. It is represented by  $\epsilon$  in the Beer-Lambert law equation.

**Fixed Slope Mode:** A Quick Slope feature in which the user provides the starting pathlength, step size, and number of data points to take.

**Good Manufacturing Practices (GMP):** A minimum set of practices recommended or required by some regulatory agencies (for example, 21 CFR, parts 808, 812, and 820) for manufacturers to meet to ensure their products consistently meet requirements for their intended use.

**Group ID:** A name for a collection of User IDs that are related to each other through common attributes such as organization, authority, and permissions.

**Installation Qualification (IQ):** A procedure documenting that the process and testing equipment, computer systems (hardware and software), and utilities are properly selected and installed according to the manufacturer's specifications and applicable code(s).

**Integrate Concentration:** Area under the concentration curve.

**Lightweight Directory Access Protocol (LDAP):** An industry standard protocol for accessing and maintaining a network directory.

**Operation Qualification (OQ):** A procedure documenting that the process and testing equipment, computer systems (hardware and software), or utility being qualified operate according to design and the required manufacturer and company specifications.

**Quick Check:** A variable pathlength software utility that allows users to rapidly assess the health and cleanliness of their variable pathlength system by making a series of transmission measurements.

**Quick Section:** Absorbance vs. pathlength data at the desired wavelength.

**Quick Slope:** A variable pathlength software utility that rapidly creates section data using the SoloVPE System. By taking measurements at various pathlengths, the utility searches for the linear range of the sample, in compliance with the Beer-Lambert law. Once found, section data (absorbance vs. pathlength) is collected. A linear regression is performed on the data set to determine the optimized slope value, which can then be used for quantitation. By default, ten data points are collected.

**R Value:** The ratio of absorbance at 260 nm to absorbance at 280 nm. In gene therapy applications, the *R* value helps to determine DNA purity; a sample is generally accepted as "pure" if the *R* value is between 1.8 and 2.0.

**R<sup>2</sup> Value:** Coefficient of determination. A statistical value between 0.0 and 1.0 that indicates the quality of the linear relationship between two variables in a data set. An *R*<sup>2</sup> value near 1.0 indicates a near-perfect linear relationship between the data. In Slope Spectroscopy, section data is regressed, and this value is used to identify the level of compliance with the Beer-Lambert law within pathlength regions.

**Rep Mode:** Style of repetition chosen in Quick Slope for continuous sample measurements. Each rep mode take place with either the Fibrette staying in the sample vessel and/or if a new search algorithm will take place before a run or not.

**Repeat:** A feature in the Quick Slope module that allows users to make multiple slope measurements of a sample in which the SoloVPE System repeats the search algorithm and collects the data based on the new search results without changing the Fibrette Optical Component or sample vessel.

**Sample ID:** An alphanumeric identifier that can be entered into the appropriate field of a data record to label the sample whose data is in the same record.

**Scan:** The process of measuring a spectrum at uniform wavelength or wavenumber intervals throughout the spectral range of interest. The interval should be small compared with the width of the absorbance bands of the sample in order to produce a quasi-continuous approximation of the sample's absorbance band characteristics. Data can be measured in terms of the transmittance, reflectance, absorbance, or scattering, at each wavelength or wavenumber.

**Scatter Correction:** A function that subtracts out absorbance contributions associated with the molecular interaction with the incident light or particle dispersion.

**Section Plot:** An absorbance vs. pathlength graph that is generated in real time as data acquisition occurs and is displayed in the software window.

**SecureVPT:** A software application that is used to configure an added layer of security for VPT products beyond the Windows operating system.

**Slope Mode–Quick:** A software mode that allows the user to take measurements based solely on a user-defined wavelength and extinction coefficient. The software finds the maximum pathlength that gives a predetermined absorbance reading, then collects data starting at that pathlength and moving downward.

**Slope Mode–Fixed:** The software setup requiring a desired start pathlength, step size, number of data points to be collected, and wavelengths.

**Slope Inquiry:** A variable pathlength software utility that rapidly creates section data. By making measurements at various pathlengths, the utility searches for the linear range of the sample, in compliance with the Beer-Lambert law. Once found, section data (absorbance vs. pathlength) is collected and a linear regression is performed on the data set to determine the optimized slope value, which can then be used for quantitation.

**VPT OPC Server:** An application that facilitates communication between the ViPER user interface, VPT hardware, and site networks. VPT OPC Server must be running in order to operate any VPT device.

**XSA:** Abbreviation for System Suitability Adapter. It is a component of the FlowVPX System that enables the FlowVPX Head to measure fluid in a vessel.

**Zero Pathlength:** The position of the Fibrette in which the tip is in contact with the bottom of the sample vessel. The SoloVPE instrument drives the Fibrette Optical Component to this position to prepare for data acquisition.

**Index**

at-line analytics..... See SoloVPE applications

Audit Log..... 74

Beams

- Best Practices..... 77, 79
- hardware..... 61, 62, 64, 65
- initialize..... 12, 38

Cary 60

- Best Practices..... 77, 79
- Fiber Optic Coupler transmission ..... 16, 17, 49, 53, 55
- white light ..... 16

Caution.....8, 58, 63, 64

Coupler Check.....16, 49, 53

data backup ..... 76

eSignature.....72, 73, 78

Flow Cell

- loading ..... 58, 64, 78
- unloading ..... 59, 65

FlowVPX applications.....10, 36, 41

gene therapy.....26, 31

in-line analytics.....See FlowVPX applications

LDAP authentication.....69, 75, 77

permission settings

- eSign roles..... 73
- Feature Access..... 72, 78
- user types ..... 70, 77
- ViPER roles..... 70, 77

Quick Check

- add to report.....21, 25, 30, 35, 41, 45, 46
- how to perform ..... 52, 56, 61
- start within application.....11, 16, 18, 23, 27, 32, 37, 42

report configuration .....46, 77

SecureVPT.....9, 70

SoloVPE applications ..... 10, 17, 22, 26, 31

system requirements .....7, 77

System Suitability Test ..... 16, 53, 56, 62

troubleshooting .....78

VPT OPC Server.....8, 75, 78

Zero Order .....See Cary 60: white light

**Customer Service**

Repligen Corporation  
 685 Route 202/206  
 Bridgewater, NJ 08807

analytics-support@repligen.com

(908) 707-1009

DOC0343 eRev. 1.0 8/23/2024