

XCell™ C410:V4B Controller

User Guide

For use with:

- XCell ATF® 4 Device
- XCell ATF® 6 Device
- XCell ATF® 10 Device



The information contained in this document is subject to change without notice.

With respect to documentation accompanying product, Repligen makes no warranty, express or implied. Any and all warranties related to the documentation accompanying product are expressly disclaimed. Customer shall refer to the terms and conditions of sale governing the transaction for any and all warranties for the Product.

Repligen Corporation shall not be liable for errors contained herein or for incidental or consequential damages in connection with the furnishing, performance, or use of this material.

No part of this document may be photocopied, reproduced, or translated to another language without the prior written consent of Repligen Corporation.

Products are not intended for diagnostic or therapeutic use or for use in vivo with humans or animals.

For further information, please contact Repligen Corporation at www.repligen.com.

©2022 Repligen Corporation. All rights reserved. The trademarks mentioned herein are the property of Repligen Corporation and/or its affiliate(s) or their respective owners.

Customer Support

customerserviceUS@repligen.com

+1-800-622-2259 (Option 1)

Repligen Corporation

111 Locke Drive

Marlborough, Massachusetts 01752

www.repligen.com

Contents

1.	Description of the XCell ATF® Device and process	8
2.	XCell ATF® Device pump cycle	10
3.	XCell ATF® Device control scope and objectives	11
4.	XCell™ C410:V4B Controller layout.....	14
4.1	General layout	14
4.2	Filtration assembly (Stainless-steel)	14
4.3	Electrical Enclosure (E-Box)	15
4.4	Pneumatic Enclosure (P-Box) components	16
4.5	Pneumatic Enclosure (Power separation) components	16
4.6	Primary pneumatic services.....	17
4.7	Primary electric services.....	17
4.8	Disconnecting the controller	18
4.9	Signal.....	18
5.	XCell™ C410:V4B Controller process and control.....	18
5.1	Control overview	18
5.2	Control functional algorithms.....	20
5.3	Interface and screens	21
5.4	Description of screens and buttons.....	22
5.5	Set-up.....	25
5.6	Admin.....	34
5.7	Batch info.....	38
5.8	Logoff.....	40
5.9	Start-up.....	40
5.10	Examples.....	42
6.	Spectrum® Hollow Fiber Module (HFM) and diaphragm replacement.....	43
6.1	Separating the filtration assembly from the bioreactor.....	43
6.2	HFM removal	43
6.3	HFM insertion	44
6.3.1	S-Line HFM insertion	44
6.3.2	Line HFM insertion	45
6.4	Screen Module replacement	45
6.5	Diaphragm replacement.....	45
6.6	Assembly.....	46
6.7	Use.....	46
7.	Sterilization	46
7.1	Preparation of filtration assembly for autoclaving.....	46
7.2	Autoclave cycle	47
7.3	Sterilization of Filtrate/Harvest line	48
8.	Connection of the XCell ATF® Device to a bioreactor.....	48
8.1	Hard connection	48
9.	Maintenance	49
9.1	Diaphragm	49
9.2	Pump air inlet filter.....	49
9.3	O-rings, gaskets and quick connects.....	49
10.	Appendix 1: Cycle vs flow rate.....	50
11.	Appendix 2: Access levels to the XCell™ C410:V4B Controller	50
12.	Appendix 3: Controller lists - Alarm, warning, inputs, and outputs	58
13.	Appendix 4: Profinet® communication	61
13.1	XCell™ C410:V4B Controller Profinet® set-up and connectivity.....	61
14.	Appendix 5: Profibus communication	62
14.1	Remote Control Mode.....	62
14.2	Input signals (from Master to XCell ATF® Device)	62

14.3	Output signals (to Master from XCell ATF® Device)	62
14.4	Profibus configuration for DCS integration	63
14.5	Black-Box configuration	63
14.6	Prerequisites	63
14.7	Remote set-up	63
14.8	Remote start	63
14.9	Remote stop	63
14.10	Remote running	63
14.11	System-stop	63
14.12	Calibration process	64
14.13	Calibration example	64
14.14	Profibus input signals (from Master to XCell™ ATF Controller)	66
14.15	Profibus output signals (from XCell ATF® Device to Master)	74
15.	Appendix 6: Delta V example configuration	85
15.1	Install the GSD File in Delta V Explorer	85
15.2	Add new Profibus Device	86
15.3	Select Profibus Device type	86
15.4	Address Setting	86
15.5	Verify Enabled	86
15.6	Create Slot	87
15.7	Set Slot size	87
15.8	Verify communications are functioning	88
15.9	Create signals	89
15.10	Create a Real datatype tag	89
16.	Appendix 7: OPC communication	90
16.1	Remote Control Mode	91
16.2	Input Signals (from Master to XCell ATF®)	91
16.3	Output Signals (to Master from XCell ATF® Device)	91
16.4	OPC Configuration for DCS integration	91
16.5	Black-Box configuration	92
16.6	Prerequisites	92
16.7	Remote Set-up	92
16.8	Remote Start	92
16.9	Remote Stop	92
16.10	Remote running	92
16.11	System-stop	92
16.12	Calibration process	92
16.13	Calibration example	93
17.	Appendix 8: Audit trail (If equipped)	101
18.	Appendix 9: General Information and Handling Instructions	103
19.	Appendix 10: Spare parts list	105
20.	Appendix A: Audit trail and domain user control customizations for the XCell™ ATF Control System C410-V4B-GMP	108
20.1	Purpose	108
20.2	System description	108
20.3	References	108
20.4	Software background	109
20.5	TIA Portal	109
20.6	Users, User Groups and authorizations	111
20.7	SIMATIC Logon	112
20.8	Audit trail	113
20.9	Implementation	113
20.10	TIA Portal: Creating additional users and user groups	113

20.11	TIA Portal: Authorizations and object level security	114
20.12	SIMATIC Logon	117
20.13	If TIA Portal: Audit trail.....	122
20.14	TIA Portal: Storing the Audit trail to a network location.....	123
20.15	TIA Portal: Network Time Protocol (NTP) Server Configuration	126
21.	Troubleshooting	129
22.	Index.....	130

List of tables

Table 1.	Utility requirements.....	12
Table 2.	Dimensions and weight	13
Table 3.	Secondary screens - Screens embedded within the Primary screens	21
Table 4.	Main screen display parameters.....	24
Table 5.	Basic Set-up screen display parameters	26
Table 6.	Advanced Set-up screen display parameters	27
Table 7.	Start-up Guide navigation buttons	28
Table 8.	Calibration screen display parameters	29
Table 9.	Process Trend screen control options	31
Table 10.	Alarm display parameters	33
Table 11.	Two (2) pump controller status relay states	33
Table 12.	Two (2) pump interlock relay states.....	33
Table 13.	Administration screen display parameters	35
Table 14.	Administration screen display parameters	36
Table 15.	Batch Info Overview screen display parameters.....	38
Table 16.	The Batch Info Algorithm screen display parameters	39
Table 17.	Cycle time vs. flow rate	50
Table 18.	Available permissions for user levels	51
Table 19.	Alarms/Warning list.....	58
Table 20.	Input/Output list.....	60
Table 21.	Input Page 0.....	66
Table 22.	Input Page 1.....	67
Table 23.	Input Page 2.....	69
Table 24.	Input Page 3.....	70
Table 25.	Input Page 4.....	72
Table 26.	Output Page 0.....	74
Table 27.	Output Page 1.....	76
Table 28.	Output Page 2.....	78
Table 29.	Output Page 3.....	80
Table 30.	Output Page 4.....	82
Table 31.	Output Page 5.....	84
Table 32.	OPC Inputs	95
Table 33.	OPC Outputs	97
Table 34.	OPC Outputs (Calibration parameters)	99
Table 35.	Spare parts.....	105

List of figures

Figure 1.	Filtration assembly connection XCell™ C410:V4B Controller and a bioreactor side port...9	
Figure 2.	XCell ATF® Device pump cycles	10
Figure 3.	XCell™ C410:V4B general arrangement	14
Figure 4.	Electric Enclosure connections.....	15
Figure 5.	Pneumatic Enclosure connections.....	16
Figure 6.	Power Box connections	16
Figure 7.	Pressure and exhaust cycle	18
Figure 8.	Instrument flow control schematic of XCell™ C410:V4B Controller	20
Figure 9.	Initial screen	22
Figure 10.	Main screen.....	23
Figure 11.	Basic Set-up screen.....	25
Figure 12.	Advanced Set-up	27
Figure 13.	Start-up Guide	28
Figure 14.	Calibration screen.....	29

Figure 15.	Trending screen.....	30
Figure 16.	Process Trend screen	31
Figure 17.	PV, PRV, P2, P3, P4, P5, W1 Trend screen.....	32
Figure 18.	Users.....	34
Figure 19.	Basic.....	35
Figure 20.	Batch Info Overview screen	38
Figure 21.	Algorithm.....	39
Figure 22.	Types of filter housings	44
Figure 23.	Filtration assembly prepared for autoclaving	47
Figure 24.	Siemens Indication	88
Figure 25.	Audit Viewer.....	103
Figure 26.	How SIMATIC Logon interacts with the HMI.....	113

Abbreviations

ATF	Alternating tangential flow
A2B	ATF to bioreactor
DF	Driving force
DP	Driving pressure
HFM	Hollow fiber filter module
PL	Pump liquid
PRV	Pressure regulator valve
SM	Screen module

California Proposition 65 Warning



WARNING

This product can expose you to chemicals including Cadmium, which is known to the State of California to cause cancer and birth defects or other reproductive harm. For more information go to www.P65Warnings.ca.gov.

1. Description of the XCell ATF® Device and process

The XCell ATF® Device provides an efficient means for fractionation of various mixtures. It may include the separation of mammalian cells (~ 10 microns in size) from culture medium, the separation of large particles such as micro carriers (~ 200 microns in size) from a suspension medium, or separation of some molecules from other molecules in a suspension. The user guide details the use of the XCell ATF® Device, with the XCell™ C410:V4B Controller for the separation of such components using hollow fiber filtration.

The system is designed to improve the efficiency of cell culture processing by allowing for the generation of high viable cell densities. The system can enable continuous processing and is available in stainless steel and single-use formats. Two primary components, the XCell™ C410:V4B Controller and the XCell ATF® Device pump housing, which is comprised of a diaphragm pump, filter housing and a hollow fiber filter, are used for desired operation. The controller functions to control the alternating tangential flow (ATF) action by controlling the movement of the diaphragm pump, through control of pressurization and exhaust (vacuum) to allow the up and down motion of the diaphragm in the pump housing. This action displaces a known volume of cell culture material within the retentate side of the hollow fibers. A separate pump continuously removes cell-free permeate from the system. Primary components of the current controller include a PLC (Programmable Logic Controller) with a HMI (Human Machine Interface) to control the components used in generating the alternating tangential flow action.

This User Guide pertains to both the XCell ATF® Stainless Steel- and Single-Use Devices. ([Figure 1](#)).

- **Controller:** a dedicated controller used to control and monitor XCell ATF® Device activity. It also provides the means for connecting to and controlling pressure and vacuum utilities.
- **Filtration assembly:** an assembly of two major elements, a stainless steel filter housing and a silicone diaphragm pump:
 - **Filter housing:** housing containing the filtration element, either a hollow fiber module (HFM) or screen module (SM).
 - **Diaphragm pump:** spherical housing in which a diaphragm membrane is moved up and down by pressurized air or vacuum, creating alternating flow.
 - **Single-use device:** the filter housing, hollow fiber filter and diaphragm pump are combined into a single polycarbonate device. At this point in time the SM is not available as a single-use device. Please see the [XCell ATF® Start-up Guide](#) for additional information on XCell ATF® Single-use Devices.

The filtration assembly includes the following components for each process application:

- **A2B Connection assembly:** tubing assembly connecting the filtration assembly to a bioreactor or process vessel.
- **Bioreactor adaptor:** adaptor between the connection assembly and bioreactor port. Typical ports/connectors/adaptors for stainless steel bioreactors include an Ingold-type port, tri-clamp or, if a single use bioreactor (SUB), then, a disposable aseptic connector (DAC) or equivalent.

A typical configuration of the XCell ATF® Device is shown in [Figure 1](#). The filter housing accepts either HFM, with pore sizes from 750 kD - ~0.2 micron, or a SM for fractionation of larger particles, > 70 microns. The separating element, the HFM or SM, is positioned between a process vessel or a bioreactor at one end and the diaphragm pump at the other end. The vessel serves as a storage container for the content to be filtered. The diaphragm pump provides the means for generating alternating tangential flow (ATF), moving the contents of the vessel back and forth, between the vessel and pump, through the hollow fibers of the HFM or through the SM. The XCell ATF® Device process provides the means for generating rapid, low shear, tangential flow, allowing for retention of the larger components (i.e.- cells) and filtration of smaller components (i.e. – media components). A filtrate pump as shown in [Figure 1](#) is used for controlled removal of a filtered stream. The unfiltered material remains in the system. Only a single connection is required between the XCell ATF® Device and the vessel. As shown in [Figure 1](#), the connection can be through a side port (or bottom port) commonly configured on large scale stainless steel or single-use bioreactors, or through the head plate as typical with smaller bioreactors. When placed next to the vessel, only a short connection, commonly referred to as the A2B connection, is required between the XCell ATF® Device and the vessel. This connection can be hard piped or soft piped and is made in a sterile manner. The filtration process remains closed and therefore sterility between the vessel and the XCell ATF® Device is maintained.

Figure 1. Filtration assembly connection XCell™ C410:V4B Controller and a bioreactor side port

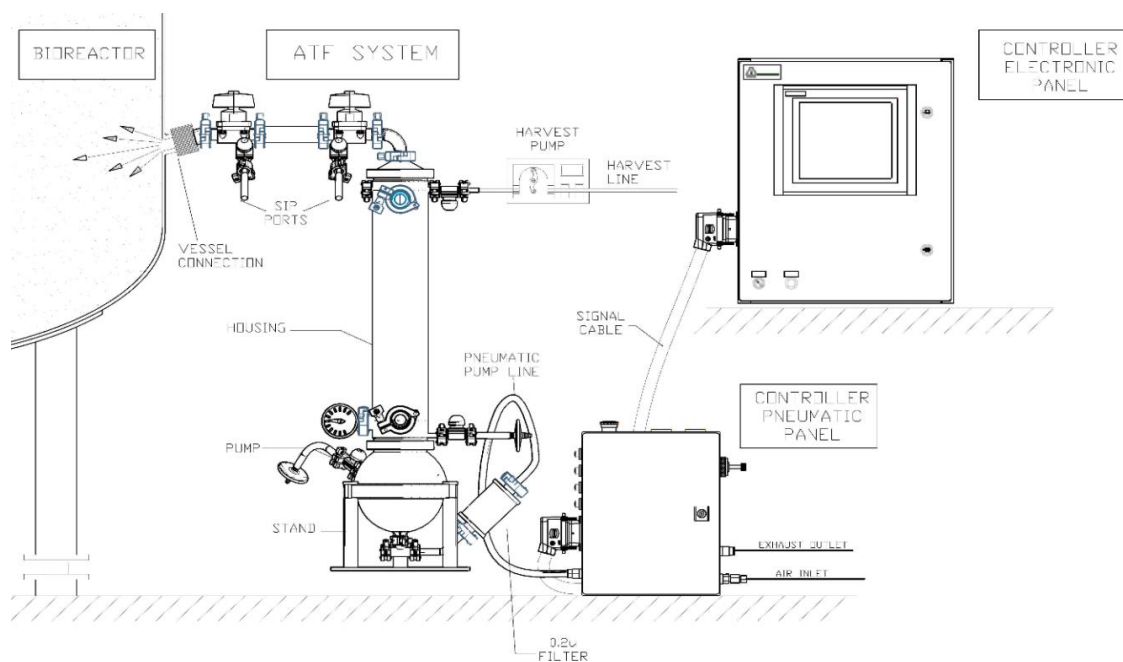

Note: XCell™ C410:V4B Controller has one additional enclosure, the Pneumatic Enclosure (P-Box) which houses the high voltage electrical components (not displayed here). Please reference the [XCell ATF® Single-use Device Start-up Guide](#) for proper single-use connectivity.

2. XCell ATF® Device pump cycle

The diaphragm pump is the heart of the XCell ATF® Device process. It produces an alternating flow through the HFM (lumen side) or SM. The XCell ATF® Device provides a pulsating, reversible, flow of liquid, back and forth, between the process vessel and the diaphragm pump. The following is a description of that process:

The diaphragm pump is partitioned into two chambers with a flexible diaphragm, [Figure 2](#). One of the pump chambers, the Pump Liquid (PL) chamber is connected to the filter housing, which, in turn, is connected to the process vessel. Therefore, any flow between the diaphragm pump and process vessel will be through the filtration device. The second pump chamber, the pump air (PA) chamber, is connected to the pump flow control system. Typically, controlled addition of compressed air into the PA chamber increases the pressure in the chamber relative to the process vessel, forcing the flexible diaphragm partitioning the two chambers to move into the PL chamber and towards the vessel. Liquid in the PL chamber is forced through the filter to the process vessel. The flow through the HFM (lumen side) generates tangential flow in one direction. This pumping phase (or cycle) in the direction of the bioreactor is called the pressure cycle. Inversely, with a pressurized process vessel relative to PA or PL, or with an external vacuum supply, liquid will flow in the reverse direction, from process vessel, through the HFM (lumen side), to the PL chamber, generating tangential flow in the other direction. This pumping phase (or cycle) in the direction of the XCell ATF® Device pump is called the exhaust cycle. These alternating pump cycles are then repeated continuously. See [Figure 2](#).

Figure 2. XCell ATF® Device pump cycles

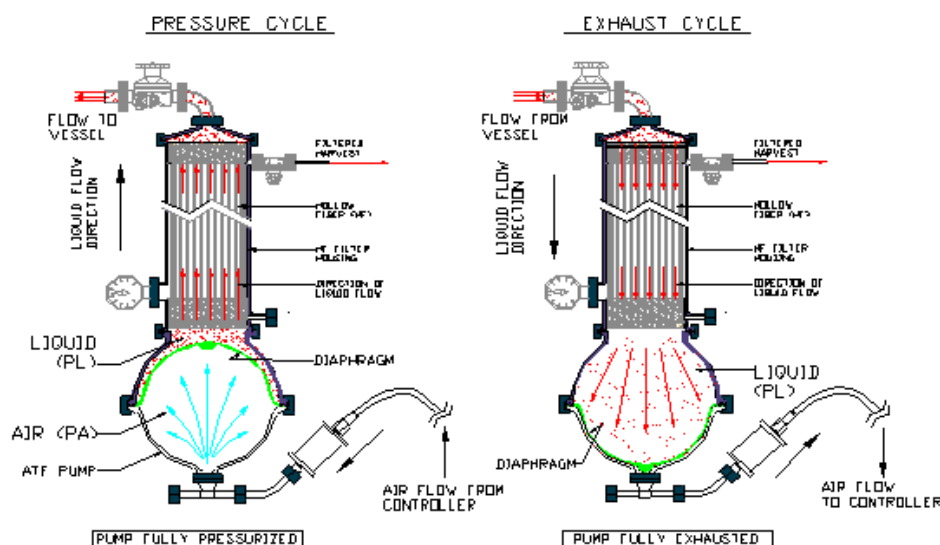

Note on the Exhaust Cycle:



WARNING: Glass bioreactors or single-use bioreactors (SUBs), unless otherwise specified by the manufacturer of the vessel, should not be pressurized. Such vessels can explode if pressurized.

If a vessel is being operated without positive pressure, the XCell ATF® Device requires a vacuum (negative pressure) to move the diaphragm to its lowest position. The PA chamber can then be alternately pressurized and evacuated to produce ATF action while maintaining the process vessel at atmospheric pressure.

Conversely, when using a vessel that that is operated under positive pressure, the vessel pressure can be used to drive the liquid from the vessel to the PL chamber. When vessel pressure is limited, it may be supplemented with vacuum. In either of the above schemes, one is driving the liquid from the vessel to the diaphragm pump by increasing the pressure in the vessel relative to the diaphragm pump. Even with positive vessel pressure assisting with diaphragm deflation, vacuum is generally required to ensure proper XCell ATF® Device operation.



WARNING: When using a glass vessel or SUB, be sure to maintain an unrestricted vent from the vessel. In the case a diaphragm fails, the air flow into the diaphragm pump will proceed through the HFM or SM into the vessel. A free exhaust from the vessel will minimize the buildup of pressure in the vessel.

3. XCell ATF® Device control scope and objectives

The XCell™ C410:V4B Controller provides the process control functionality of the stainless steel XCell ATF® 4 Device, XCell ATF® 6 Device, and XCell ATF® 10 Device, as well as the single-use XCell ATF® 6 Device and XCell ATF® 10 Device.

XCell™ C410:V4B Controller is designed to:

1. Control ATF flow rates in both pressure and exhaust cycles.
2. Provide a user interface capability for XCell ATF® Device control and monitoring.
3. Set-up and select operational parameters.
4. Display real-time process data and alarms for error conditions.
5. Provide Batch control and user hierarchy.
6. Have PLC software upgrades in the field by replacing memory modules.
7. Have 3 major enclosures, an Electric Enclosure (E-Box) a Pneumatic Enclosure (P-Box).
8. Allow the Electronics Box to operate the stainless steel XCell ATF® 4 Device, XCell ATF® 6 Device and XCell ATF® 10 Device as well as the single-use XCell ATF® 6 Device and XCell ATF® 10 Device using custom software.
9. Allow the Pneumatic Enclosure hardware and process parameters to be specific to the size of the particular XCell ATF® Device being controlled.

Table 1. Utility requirements

Utility	Requirement	Additional considerations
Primary compressed air	Maximum 90 psig/6.1 bar	Oil free, dry, filtered gas, i.e., medical grade air
Secondary pressure	Typically: 35 psi/2.4 bar,	Regulated oil free, dry, filtered air
Vacuum service	Minimum -12.5 psig	Vacuum supplied by a Repligen, or customer supplied local pump capable of maintaining ~-12.5 psig with nominal flow as follows: XCell ATF® 4 Device - 40L/min XCell ATF® 6 Device - 60L/min XCell ATF® 10 Device - 200L/min Pump should be clean room compatible
Exhaust		Untreated discharge or user specified
Steam (SIP)	~30 lbs/hr.	Applicable only to a steam able connection between XCell ATF® Device and bioreactor vessel
Condensate drain		For SIP condensate drainage
Altitude	2000 m	This product has been assessed for a maximum altitude of 2000 m.
Pollution degree	Pollution degree 2	This product is intended to be used in an environmental of pollution degree 2. Pollution degree 2 area is normally where only nonconductive pollution can be present. Temporary conductivity that is caused by condensation is to be expected.
Current	0.6 AMP	
Frequency	50/60 Hz	
Supply voltage	100 - 240 VAC (+10%, -10%)	Main supply voltage fluctuation +/- 10%
Environmental temperature, humidity	Ambient temperature (0 - 50 ° C) Low humidity (0 - 80% RH) Indoor (Dry)	Environmental specifications only apply to controller. Controller is designed to be used indoor (dry) and low humidity location

Table 2. Dimensions and weight

Component	Dimensions (H, W, D)	Description
XCell™ C410:V4B Controller		
Pneumatic Box	13 in, 10.5 in, 8 in	Includes all plugs and connectors
Pneumatic Enclosure	24 in, 24 in, 9 in	(Controls) Includes all plugs and connectors
Power Box	13 in, 10.5 in, 8 in	(Power separation) Includes all plugs and connectors
Filtration assembly		Fully assembled system
XCell ATF® 4 SS Pump Housing	24 in, 6 in, 6 x 10 in	Indicated dimensions are estimates for the filtration assembly, as the connection to the bioreactor, the connections to the controller and to accessories can affect height and effective area.
XCell ATF® 6 SS Pump Housing	44 in, 10 in, 8 x 12 in	
XCell ATF® 10 SS Pump Housing	44 in, 14 in, 14 x 20 in	
XCell ATF® 6 Single-use Device	38 in, 12 in, 10 in	
XCell ATF® 10 Single-use Device	38 in, 18 in, 16 in	

XCell™ C410:V4B Controller	Weight	Comments
Pneumatic Enclosure	~13 kg	
Electric Box (Controls)	~23 kg	
Power Box	~12 kg	(Power separation)
Filtration assembly		
XCell ATF® 4 SS Pump Housing	~6 kg	Weight does not include the weight of any liquid, filter or connection between the filtration assembly and the vessel
XCell ATF® 6 SS Pump Housing	~14 kg	
XCell ATF® 10 SS Pump Housing	~40 kg	
XCell ATF® 6 Single-use Device	~ 5 kg	Does not include the weight of liquid and A2B connectors
XCell ATF® 10 Single-use Device	~ 18 kg	

4. XCell™ C410:V4B Controller layout

4.1 General layout

The controller consists of three major components:

- Pneumatic Enclosure
- Electronics Enclosure
- Power-Box

[Figure 3](#), shows the details.

The Electronics and the Pneumatic Enclosure interconnected with a cable that relays signal and power. A general layout with the XCell ATF® Device is shown in [Figure 3](#). the primary design objective is to produce a modular system that will maximize adaptability of the system to the various space requirements of the user's facilities. One can envision the Pneumatic Enclosure in proximity to the filtration assembly, while Electric Enclosure positioned distant to the Filtration assembly, possibly mounted on a wall or a skid. A stainless-steel cart, specifically designed to house the three controller components, and supporting components (vacuum pump, peristaltic pump and paperwork) is available for purchase.

Figure 3. XCell™ C410:V4B general arrangement

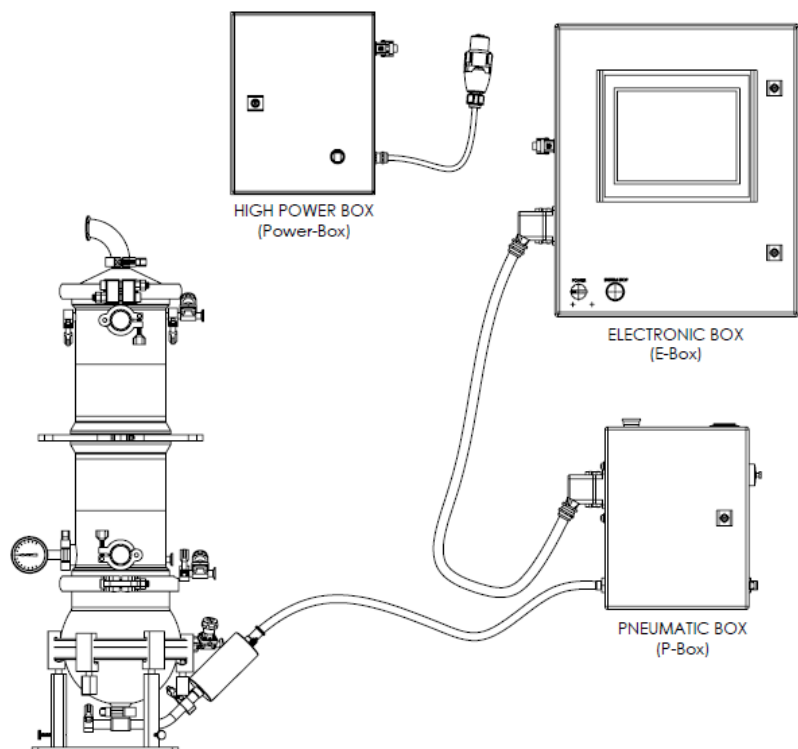

4.2 Filtration assembly (Stainless-steel)

This includes the diaphragm pump, filter housing, connection to the bioreactor, harvest line; pump air inlet assembly, stand, plus all the housing accessories as specified in the part list. The housing is not included with the controller.

4.3 Electrical Enclosure (E-Box)

The Electric Enclosure contains the HMI and PLC components, including the Siemens S7-1200 PLC, programmed using Siemens Step 7 Basic v16. The Operator Interface Terminal (OIT or HMI) is a Siemens SIMATIC TP 1200 Comfort, programmed using Siemens WinCC Advanced v16.

Figure 4. Electric Enclosure connections

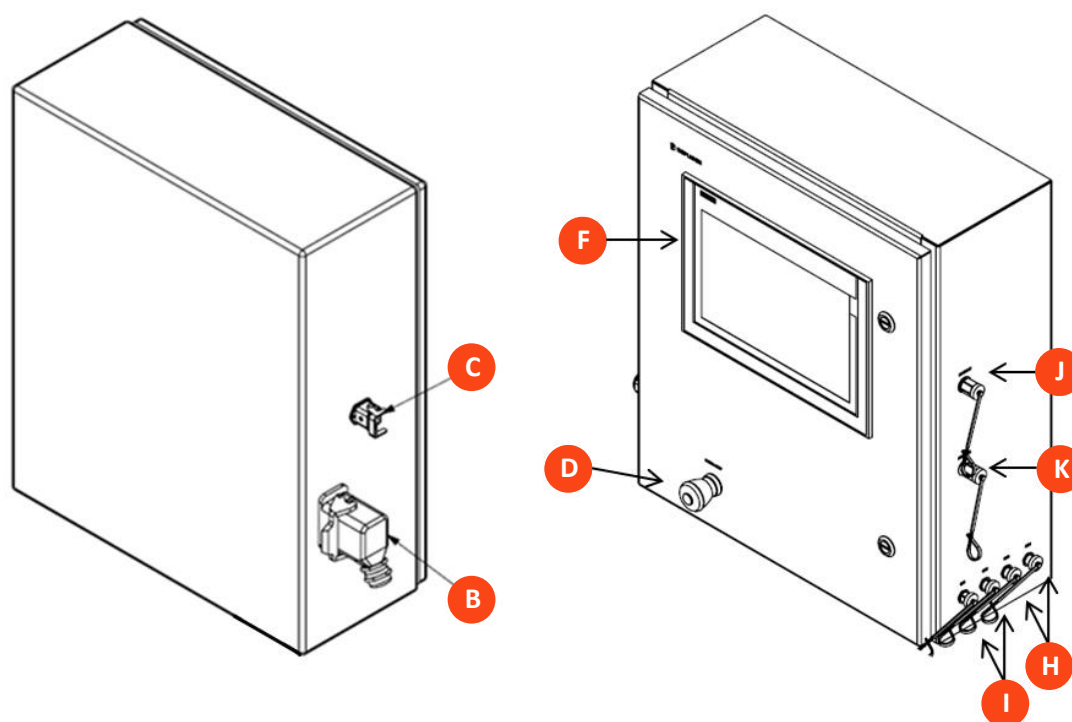

Electric Enclosure components

- A. NA (not available for XCell™ C410:V4B Controller)
- B. Interconnected cable plug (pneumatics)
- C. Interconnected cable plug (power)
- D. Illuminated system stop button
- E. n/a. Illuminated On/OFF switch relocated to Pneumatic component u in XCell™ C410:V4B
- F. HMI/OIT Display
- G. n/a (not available for XCell™ C410:V4B Controller)
- H. Harvest pump relay outputs (2)
- I. Alarm relay outputs (2)
- J. Ethernet connection port
- K. Profibus connection port

4.4 Pneumatic Enclosure (P-Box) components

Figure 5. Pneumatic Enclosure connections

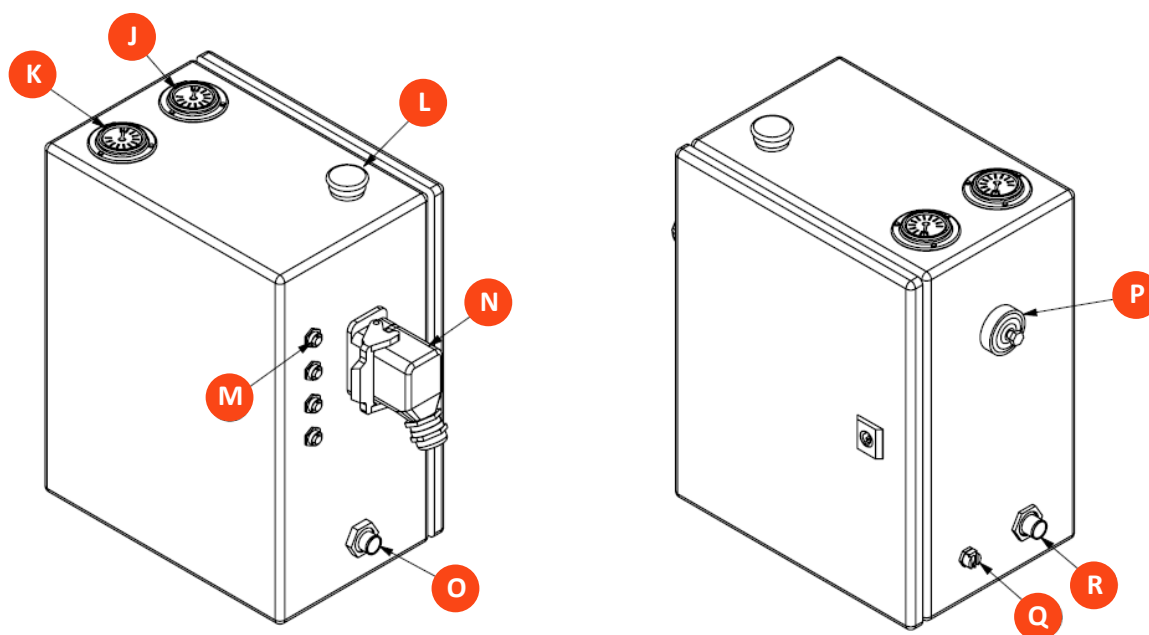

- L. Pressure gauge (0 to 60 psi, 0 to 4.1 bar)
- M. Vacuum gauge (0 to -14 psi, 0 to -0.95 bar)
- N. System STOP switch
- O. Plugs for sensor inputs (4x4 -20 mA)
- P. Interconnect cable plug (pneumatics)
- Q. Connection for diaphragm pump
- R. Pressure regulator (0 - 60 psi, 0 - 4.1 bar)
- S. Connection for compressed air
- T. Connection for vacuum supply

4.5 Pneumatic Enclosure (Power separation) components

Figure 6. Power Box connections

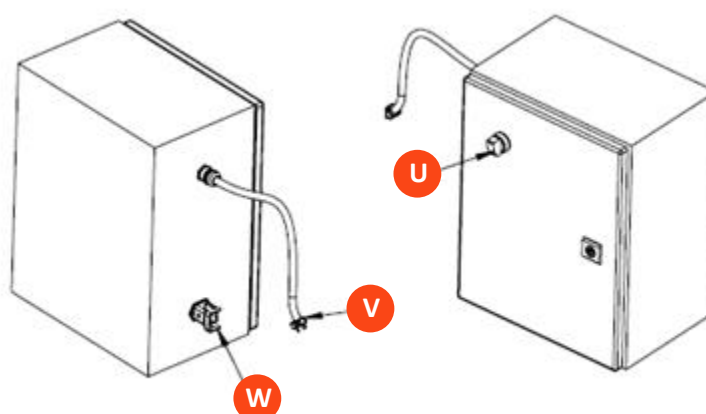

- U. Interconnected cable plug (power)
- V. Mains power plug, 120/220 vac 60/50 hz
- W. Illuminated On/Off switch

***Note:** The electric plug design may vary depending on geography

4.6 Primary pneumatic services

Air inlet (q) - Located on the Pneumatic Enclosure and provides an inlet to house compressed air source. Recommended minimum air pressure requirement is ~50 psi / 3.4 bar. Somewhat higher inlet pressures may be required, as needed, to generate higher flow rates or to drive pneumatic instruments.

Do not exceed 90 psi / 6.1 bar on the air inlet

Exhaust/ vacuum line (r) - Located on the Pneumatic Enclosure. Leaving the exhaust outlet open to the atmosphere or connected to a vacuum line, will depend on the type of process vessel used. For a vessel that cannot be pressurized (e.g., some stainless-steel vessels, glass vessels, SUB, etc.), the line is connected to a vacuum source. For a vessel that is pressure rated, one may use vessel pressure to drive the Exhaust cycle, particularly at low XCell ATF® Device flow rates; but in case where vessel pressure is limited, or at high XCell ATF® Device flow settings, a vacuum source supplement may be required.

Note: *In addition to vessel pressure, the hydrostatic pressure generated by the height difference between vessel liquid level and pump level may assist or hamper the exhaust flow*

Pump line (o) - Located on the Pneumatic Enclosure. The line connects the Pneumatic Enclosure to the diaphragm pump. A hydrophobic 0.2 micron filter in this line provides both a sterile barrier and a potential barrier to the back flow of liquid from diaphragm pump to controller should a diaphragm rupture.

Note: *Be sure to use the hydrophobic filter in the pump line to prevent accidental flow of liquid from the Filtration assembly to the Pneumatic Enclosure.*

Air Pressure Regulator - Typical range of regulator is **0 - 60psi/ 4.1bar**. This is a second stage pressure regulator for regulating service air inlet pressure to a specified, user required, value.

Note: *Typically, the secondary air pressure is regulated to 35 psi / 2.4bar. That value is selected because that pressure is recommended to drive the proportional pressure control valve PRV1 and it is generally the upper limit of the pressure required to achieve set flow rates.*

Air Pressure Gauge (j) - Located on the upper side of the Pneumatic Enclosure. Typical range of gauge is 0-60 psi. It shows second stage system pressure.

Vacuum Gauge (k) - Located on the upper side of the Pneumatic Enclosure. Typical range of gauge is 0 to -14 psi / -0.95 bar. It shows primary vacuum pressure status.

4.7 Primary electric services

Electric plug (t) - Located on the power separation portion of Electronics Enclosure. Electric power (standard 100 - 240V AC, 60/50 Hz).

Power switch (u) - Located on power separation portion of Electronics Enclosure.

Power indicator light (u) - same as the power switch. Lights green when power is ON

System Stop button (d, l) - located on the Pneumatic Enclosure and Electronics Enclosure.

Either System Stop button causes the system to cease operation and default to Standby Mode. Here the diaphragm pump defaults to exhaust.



WARNING: System Stop Button is not an emergency stop.

4.8 Disconnecting the controller

1. Controller must stay connected to the Power supply enclosure to function.
2. Controller must be placed clear from the any other cord in the workstation/bench top for safety.
3. Filters and tubing must be connected away from the appliance inlet for Power supply enclosure for operator safety in case of disconnecting device.
4. Press ON to allow the controller to continue its previous status, following a power failure.
5. On the switch adjacent to the power cord, Press OFF to allow the controller status to default to STOPPED status, following a power failure or in need for a disconnect
6. Supply cord is detachable and must be kept clear behind the product to avoid operator from safety hazards.

4.9 Signal

A total of 4 Sensor input plugs (m) are provided on the Pneumatic Enclosure. All inputs are analogue 4 - 20 mA. Three plugs P3, P4 and P5 are for pressure inputs. One plug W1 is for a load cell input.

Ethernet/Profibus (g) - communication port for data acquisition on Electronics Enclosure.

Relays – Two relay outputs are for relaying alarm conditions (i). Two relays for driving a harvest pump (h).

Interconnect (Signal) Cables (I-Cable) - to relay signal and DC power between Electronics Enclosure and Pneumatic Enclosure.

5. XCell™ C410:V4B Controller process and control

5.1 Control overview

When the pressure cycle starts, the pressure to the diaphragm pump rapidly increases (as measured by the P2 pressure sensor in the controller). At some critical pressure, the diaphragm begins to move, and the PA begins to expand. As the PA expands, P2 levels off and must be sustained to maintain the expansion of the PA. This critical P2 pressure is also known as the driving pressure or driving force (DP or DF).

Figure 7. Pressure and exhaust cycle

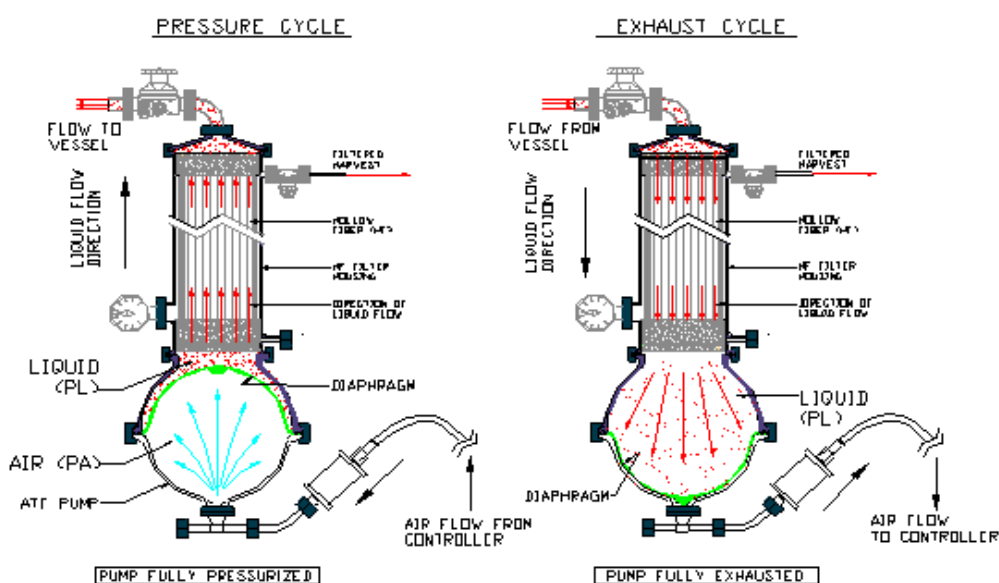

Once the PA is fully inflated, the pressure within the pump chamber will begin to spike; e.g., the diaphragm stops moving and begins to stretch. The controller takes advantage of this spike by using a cycle Switch Offset (SO) to indicate when to switch to the exhaust cycle. Similar mechanism applies to the exhaust cycle.

To assure optimum results with the XCell ATF® Device, one should keep in mind the following two general rules:

1. The diaphragm motion must be a continuous one between the Pressure cycle and the exhaust cycle and vice versa (i.e., no dwell time).
2. Ideally, the stroke travel of the diaphragm must be reversibly between fully Pressurized and fully exhausted extremes.

Note: *There should be no dwell time for the diaphragm at any point of the cycle.*

The continuous movement of the diaphragm assures continuous tangential flow through the filter. The maximum stroke of the diaphragm assures maximum mixing and minimizing dead space retention within the system.

Control of the XCell ATF® Device is based on the above two rules.

The XCell ATF® Device, having a constant pump volume, allows the controller to calculate the diaphragm pump cycle time based on a user's flow rate selection, according to the following relationship:

$$\text{Cycle time (min)} = \text{Pump displacement volume(L)} \div \text{ATF Flow Rate(L/min)}$$

The programmed pump displacement volumes, with no pressure difference across the diaphragm, are:

XCell ATF® 4 Device	0.44 L
XCell ATF® 4MC Device	0.44 L
XCell ATF® 6 Device	1.2 L
XCell ATF® 10 Legacy Device	5.1 L
XCell ATF® 10 Device	6.0 L

See also [Appendix 1](#). Cycle time vs. Flow rate.

Therefore, selection of a **Flow rate (L/min)** by a user, using an XCell ATF® Device with a known **Pump displacement volume (L)**, it is possible for the XCell™ C410:V4B Controller to calculate the **Pump's Cycle time, calculated CT**.

At the end of each pump cycle, the actual cycle time, **actual CT**, is compared to the **calculated CT**. The controller then uses the error between the two values to correct **actual CT** to equal **calculated CT**. Similarly, the XCell™ C410:V4B Controller also allows the user to enter XCell ATF® Device cycle time (sec) directly to control flow rate; again, at the end of each pump cycle, the Actual CT is compared to the Calculated CT. The XCell™ C410:V4B Controller is designed to maintain the set flow rate automatically during the Pressure and Exhaust pump cycles. Based on an entered set point in either Liters per minute, LPM, or Time, in seconds, the XCell™ C410:V4B Controller will continually adjust the pressure and exhaust flow rates to match the entered set point flow rate.

Figure 8. Instrument flow control schematic of XCell™ C410:V4B Controller

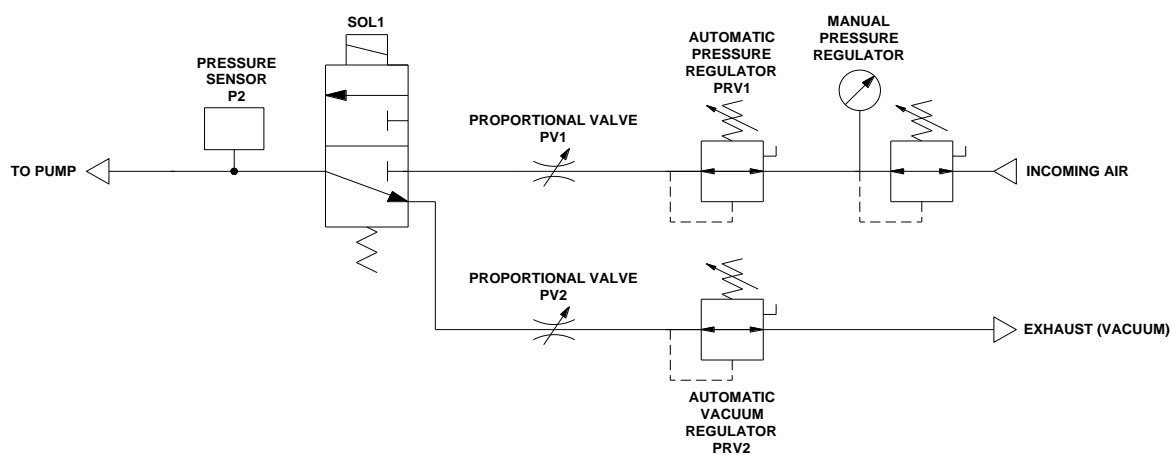

XCell ATF® Device flow control is achieved by regulating the pneumatic air flow to and from the Diaphragm pump; the pneumatic flow control is achieved with a two-stage control, by regulating its pressure and with a flow restrictor. Two proportional pressure regulators valves, PRV1 and PRV2, are designed to make fine adjustments in pressure to the air stream flowing from the manual pressure regulator to a flow restrictor. Two automated flow restrictors, proportional flow control valves, PV1 and PV2, are designed to make coarse adjustments in flow. Final flow control is achieved by Step changes in PV orifice opening in combination with fine adjustments in the air flow stream pressure with the PRV.

Adjustments in flow are based on the error difference between Calculated CT and Actual CT. The proportional air pressure regulating valve, PRV1, and the exhaust pressure regulating valve, PRV2, will be adjusted by the PLC based on the Error. The error will cause pressures to be changed to affect the flow, positive or negative, respectively, to and from the pump to match flow set point for the next cycle. If the new value for PRV1 and/or PRV2 exceed their set pressure limits, (e.g., PRV1 0 to 30 psi, PRV2 0 to -14.5 psi), then, the respective PV1 and PV2 will adjust incrementally, (e.g., by user defined increments (in the Basic Set-up screen)), until the PRVs are back within operational range.

5.2 Control functional algorithms

The XCell™ C410:V4B Controller utilizes several algorithms to determine when the diaphragm pump switches cycle direction. The principal method is based on first detecting a steady state pressure phase or driving force during each pump cycle followed by addition of a switch offset, i.e., a pressure

increment (or spike). A cycle change is executed when actual pump pressure (as determined by P2) is equal or greater than the sum of driving force pressure and switch offset pressure.

The parameters and configuration within this manual should not be changed without consultation with a Repligen representative. The controller, when properly maintained and serviced, should be able to handle almost all cell culture conditions and viscosities.

Should you determine that the controller is not functioning correctly and exchanging the full volume of the diaphragm pump with each stroke, please immediately contact Repligen for further assistance.

5.3 Interface and screens

A Siemens Operator Interface Terminal (OIT) provides the user with the following features:

1. Pump Status including cycle rate, flow rate, pressures, controller status and total batch cycles
2. Set-up Parameters
3. Acknowledge and clear machine faults (i.e., alarms)
4. Process Trending

When an input box is highlighted and pressed; a number pad or keyboard will appear on screen to enable data input.

For numerical entries as the value is being typed, a Min and Max range dialog box appears, showing the user the acceptable value range. Any value outside the min/max range, or any text strings or letters is not accepted.

The OIT will display the following Primary screens:

Primary screens - Initial, Main, Set-up, Alarms, Trending, Batch, Administrator, Log off.

Table 3. Secondary screens - Screens embedded within the Primary screens

Screen	Description
Initial	Initial system log on which appears when the XCell™ C410:V4B Controller first powers up; <i>unless configured to be black box</i>
Main	Main diaphragm pump control and Monitoring displays real time pump status access to all primary screens
Set-up	Users' set-up of process parameters, calibration, and diaphragm pump parameters
Alarms	Display diaphragm pump warnings and faults
Trending	Graphical real time display of flow set point, exhaust set points, flow process value, vessel weight
Batch-info	Batch Set-up screen
Administration	Setting of users ID, security level and passwords, Close application, PLC ON/OFF
Log off	Users' logoff

5.4 Description of screens and buttons

Figure 9. Initial screen

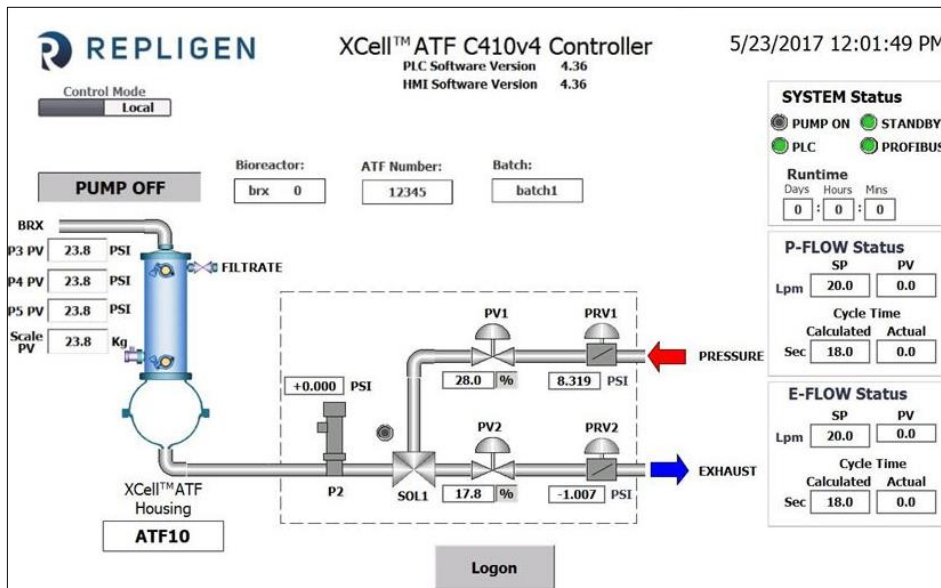

The Initial screen appears when the XCell™ C410:V4B Controller is powered up. Press the Logon button to bring up the User/Password Dialog Box and Keyboard. For first time use, enter ADMIN for USER and 1234 for PASSWORD. Many of the main screen parameters are actively displayed (as read only) on this screen for user convenience. Logging on is not required to observe remote control operations.

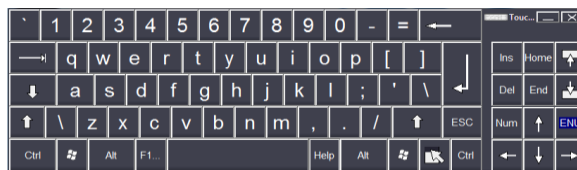
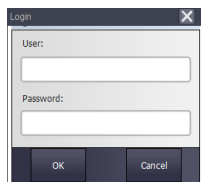
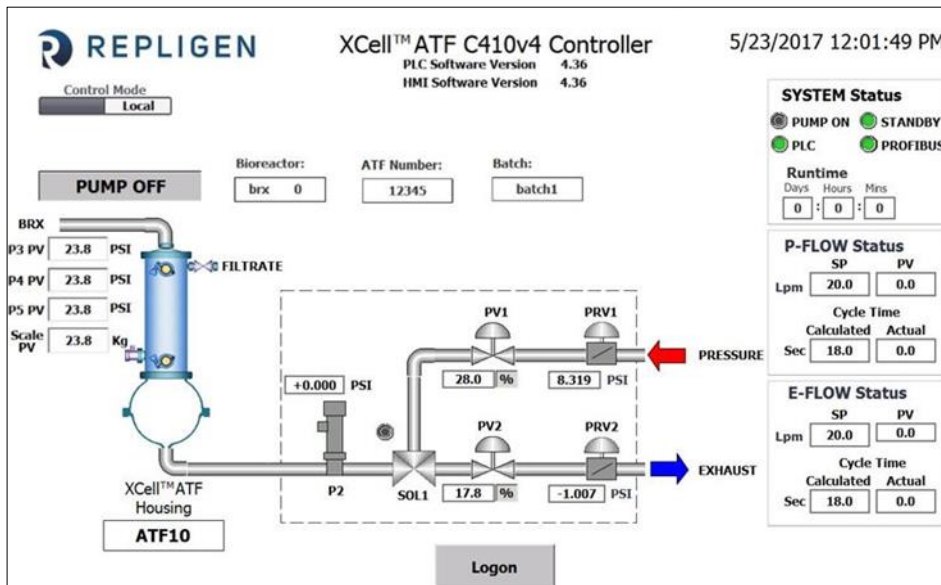
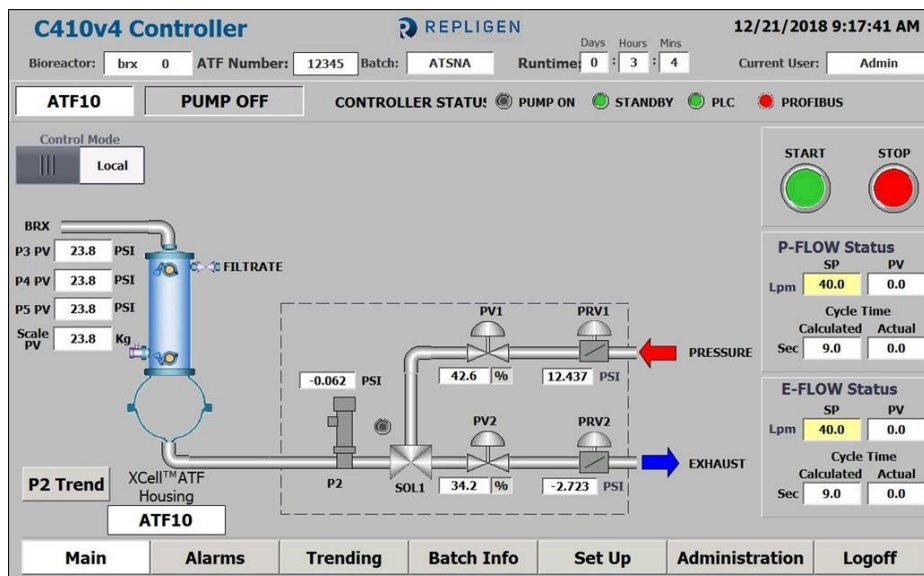

Figure 10. Main screen



The Main screen provides an overview of the XCell ATF® process. It displays a schematic/animation for pneumatic process, a diaphragm movement /cycle, valve transition between pressure and exhaust cycles and flow direction. From the Main screen, an operator can:

1. Monitor and control XCell ATF® Device processes. In the Main screen and all subsequent screens, all data fields with a white background are for display only. The operator, based upon security levels, can change data fields with a beige background.
2. Start/Stop diaphragm pump.
 - a. When starting the diaphragm pump, a dialog box will appear to enable the user to start with current settings, start with default settings or cancel and return to the main screen.
 - b. When stopping the diaphragm pump, a dialog box will appear that enables the user to confirm the stop command, or to cancel and return to the main screen.
3. Access other screens based upon password security levels.
4. Observe P2 trending. A P2 Trend button hides /unhides this screen.
5. Observe an animated diaphragm pump showing pressurization (inflation) and exhaust (deflation) cycles of the diaphragm pump.
6. Monitor Overtime condition- displayed in Flow status sub screens, by change of actual cycle time field to red.
7. Monitor Overflow condition- displayed in Flow status sub screens, by change of actual cycle time field to orange.

Table 4. Main screen display parameters

Field	Description
Date/Time	Displays current Date and Time
User ID	Displays current User ID
Entries in Main screen	Field entries by Administrator (or, if authorized, by Engineer) through the Main screen: P-FLOW SP, E- FLOW SP, PV1, PRV1, PV2, PRV2
P-FLOW SP	Displays current P-Flow Set Point (SP) (LPM)
P-FLOW PV	When running, displays pump Flow rate Process Value (PV) of last pump cycle (LPM)
P-FLOW Calculated	Displays current P-Flow calculated cycle time (Sec)
P-FLOW Actual	When running, displays Actual pump flow cycle time of last pump cycle (Sec)
E- FLOW SP	Displays current E-Flow Set Point (SP) (LPM)
E- FLOW PV	When running, displays pump exhaust Flow rate Process Value (PV) of last pump cycle (LPM)
E-FLOW Calculated	Displays current E-Flow Calculated cycle time (Sec)
E-FLOW Actual	When running, displays Actual pump exhaust cycle Time of last pump cycle (Sec)
PV1	Displays current position Set Point of Flow Proportional Valve (0-100%)
PV2	Displays current position Set Point of Exhaust Proportional Valve (0-100%)
PRV1	Displays current setting of automatic pressure regulator (0 to 35psi)
PRV2	Displays current setting of automatic exhaust regulator (-15 to 0 psi)
P2	Displays current pressure between controller and Diaphragm pump (PSI)
Controller status	Displays current controller status: Pump Off Inflating Exhausting Pump Warning Pump Alarm System Stop

Indicator	Description
PLC	Indicates controller PLC is ON and in RUN mode
Pump ON	Indicates diaphragm pump is in RUN mode
Standby	Indicates controller OFF/ON Status
SOL 1	Indicates flow direction Solenoid is OFF/ON
Bioreactor	Connected bioreactor ID (input in set-up basic)
Batch	Batch ID information (input in Batch Info)
Runtime	Time the current batch has been running (reset in Batch Info)
Current user	Displayed username of current login

Button	Description
Start	Press to START diaphragm pump
Stop	Press to STOP diaphragm pump
P2 Trend	Press to toggle view the XCell ATF® Device Cycle (P2 Trend) Popup
All Primary	All Primary screen buttons are displayed to navigate to those screens. Alarms, Trending, Batch Info, Set-up, Administration
Control Mode	Switches the controller from remote to local operation

When starting the diaphragm pump, the following dialog box will appear:

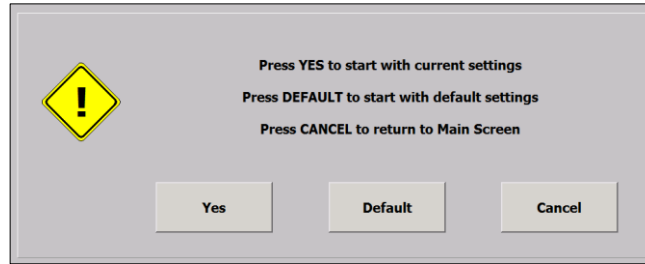

Yes setting is preferred when stopping the diaphragm pump and restarting with the same flow rate or process settings (i.e., same PRV and PV values as when the diaphragm pump last ran).

Default setting is preferred when starting the diaphragm pump with new flow rate settings or new process set-up (e.g., different bioreactor configuration and parameters). This minimizes the number of cycles taken by the controller to reach the desired flow rate. At any selected flow rate, default simply resets the control parameters to factory preset values.

Cancel will return to the main screen without any action taken.

When Stopping the Diaphragm pump, the following dialog box will appear:

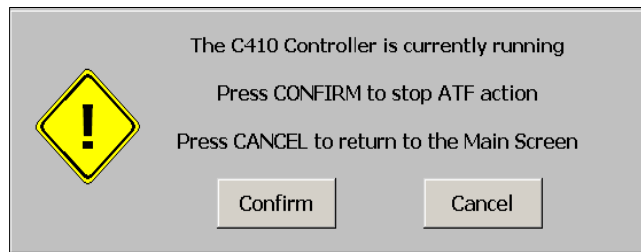

5.5 Set-up

From the Set-up screen, an Engineer/Administrator can make entries in the following:

- Basic Set-up screen
- Help guide
- Advance Set-up screen
- Exit to Primary screens
- Calibration screen
- Navigate to the following Secondary screens

Figure 11. Basic Set-up screen

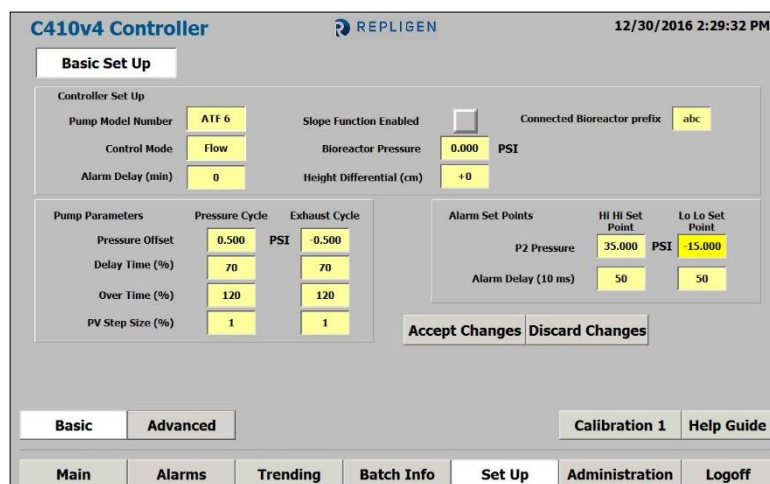

From the Basic Set-up screen, an Engineer/Administrator can:

1. Set initial Controller set-up.
2. Change HiHi and LoLo Alarm setpoints.
3. Change process parameters.
4. Access other screens based upon password security levels.

Table 5. Basic Set-up screen display parameters

Field	Description
Controller Set-up	Groups the following fields:
Pump Model No	Press to select Pump Model No. XCell ATF® 4 Device, XCell ATF® 4MC Device, XCell ATF® 6 Device, XCell ATF® 10 Legacy Device, XCell ATF® 10 Device. These settings apply to both stainless steel and single-use devices.
Control Mode	Press to select Control Set Point units (FLOW or TIME)
Alarm Delay(min)	The amount of time in minutes the controller will stay in warning condition before switching to alarm condition. (If 0 is entered system will remain in warning condition.)
Slope Function Enable	Integrates P2 slope at Delay Time to extrapolate Cycle Switch Pressure.
Bioreactor pressure	Expected bioreactor operating pressure.
Δ height	The height difference between bioreactor liquid level and middle of Diaphragm pump (in cm).
Connected Bioreactor Prefix	The Prefix assigned to the bioreactor connected to the XCell ATF® Device.
P2 limits	Sets P2 upper and lower allowable limits.
HiHi Alarm Set points	Sets a high limit on P2 pressure during the P-Flow Cycle If P2is ≥ HIHI, follow with ALARM and System Stop.
LoLo Alarm Set point	Sets a low limit on P2 pressure during the E-Flow Cycle If P2is ≤ LOL, follow with warning.
Alarm delay (msec)	Delays response to HIHI and LOLO Set point. If the alarm parameter is set for 0 minutes, it will remain in a Warning state. If the field is set 1 - 50 minutes, after that time elapses the system will go into an Alarm state which will put system in a halt condition.
Pump parameters	Groups diaphragm pump parameters.
P-Pressure offset (psi)	Pressure cycle: Pressure offset or-Over pressure set point (P-OSP1) value (psi) above P2 to switch from Flow (or Pressure) cycle to exhaust.
E-Pressure offset (psi)	Exhaust cycle: negative Over pressure Set Point (E-OSP2) value (psi) below P2 to switch from Exhaust cycle to Flow or Pressure cycle.
P-Delay (%)	Sampling point of sP2 during the Pressure cycle (% of total cycle time, preset range 10 - 90%).
E-Delay (%)	Sampling point of sP2 during the Exhaust cycle (% of total cycle time, preset range 10 - 90%).
P-Overtime (%)	Sets the overtime limit to the Pressure cycle (% of calculated cycle time).
E-Overtime (%)	Sets the overtime limit to the Exhaust cycle (% of calculated cycle time).
P-PV Step size (%)	Sets the (%) incremental change in PV1 when PRV1 exceeds its set limits.
E-PV Step size (%)	Sets the (%) incremental change in PV2 when PRV2 exceeds its set limits.

Button	Description
Advance Set-up	Press to switch to Advanced Set-up screen
Help guide	Press to switch to Start-up (Help) Guide screen
Calibration	Instrument calibration
Accept/Discard change	Accept change and discard change to accept or reject any parameter change on the screen.
All Primary	All Primary Screen buttons are displayed to navigate to those screens

Figure 12. Advanced Set-up

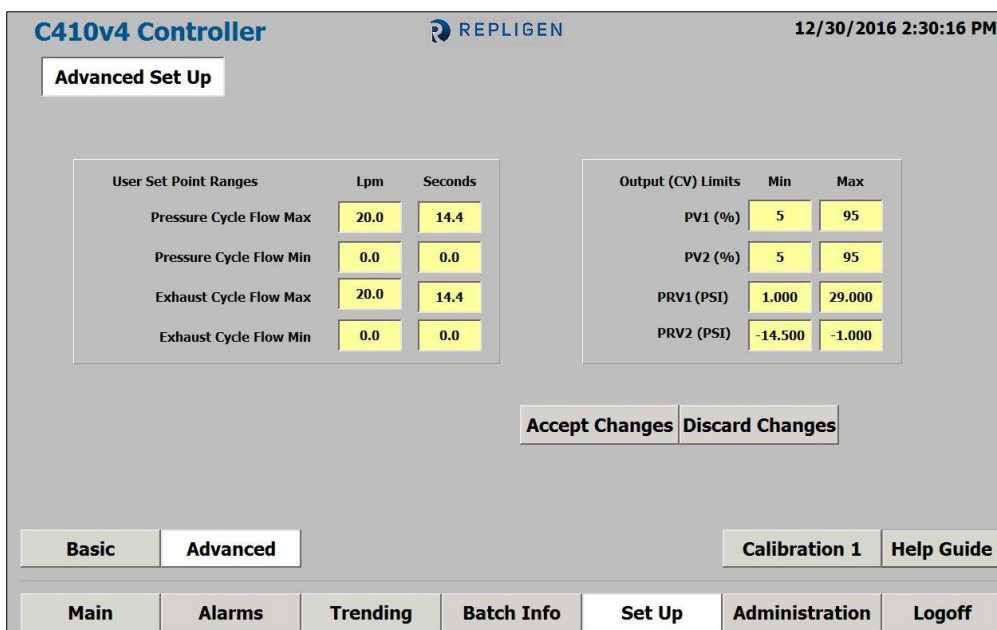

From the Advanced Set-up Engineer/Administrator can set the following diaphragm pump parameters:

Table 6. Advanced Set-up screen display parameters

Field	Description
Max P-FLOW (LPM)	Maximum limit for Pressure FLOW set point (LPM)
Max P-FLOW (sec.)	Maximum limit for Pressure FLOW set point (Seconds)
Min P-FLOW (LPM)	Minimum limit for Pressure FLOW set point (LPM)
Min P-FLOW (sec.)	Minimum limit for Pressure FLOW set point (Seconds)
Max E-FLOW (LPM)	Maximum limit for Exhaust FLOW set point (LPM)
Max E-FLOW (sec.)	Maximum limit for Exhaust FLOW set point (Seconds)
Min E-FLOW (LPM)	Minimum limit for Exhaust FLOW set point (LPM)
Min E-FLOW (sec.)	Minimum limit for Exhaust FLOW set point (Seconds)
PV1 Max (%)	Maximum operating limit for PV1 (%)
PV1 Min (%)	Minimum operating limit for PV1 (%)
PV2 Max (%)	Maximum operating limit for PV2 (%)
PV2 Min (%)	Minimum operating limit for PV2 (%)
PRV1 Max (psi)	Maximum operating limit for PRV1 (psi)
PRV1 Min (psi)	Minimum operating limit for PRV1 (psi)
PRV2 Max (psi)	Maximum operating limit for PRV2 (psi)
PRV2 Min (psi)	Minimum operating limit for PRV2 (psi)

Button	Description
Basic Set-up	Press to switch to Basic Set-up screen
Help guide	Press to switch to Start-up Guide screen
Calibration	Instrument calibration
Accept/Discard change	Accept change and discard change to accept or reject any parameter change on the screen.
All Primary	All Primary screen buttons are displayed to navigate to those screens

Figure 13. Start-up Guide

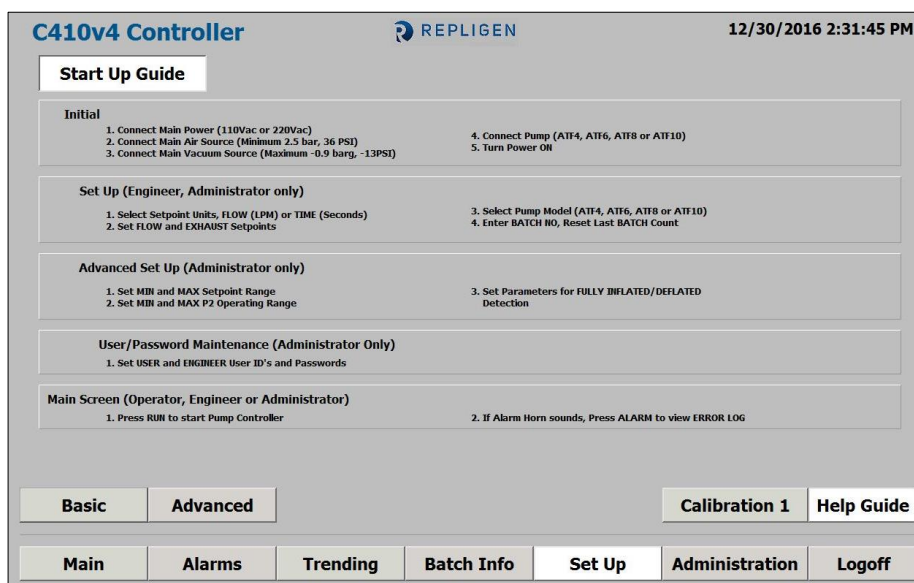

The Start-up Guide page shows a quick reference guide for the operator. This information should be reviewed by all Users before operating the XCell™ C410:V4B Controller. The Start-up Guide screen does not display parameters.

Table 7. Start-up Guide navigation buttons

Button	Description
Basic Set-up	Press to switch to Basic Set-up screen
Advanced Set-up	Press to switch to Advanced Set-up screen
Calibration 1	Equipment calibration
All Primary	All Primary screen buttons are displayed to navigate to those screens

Figure 14. Calibration screen

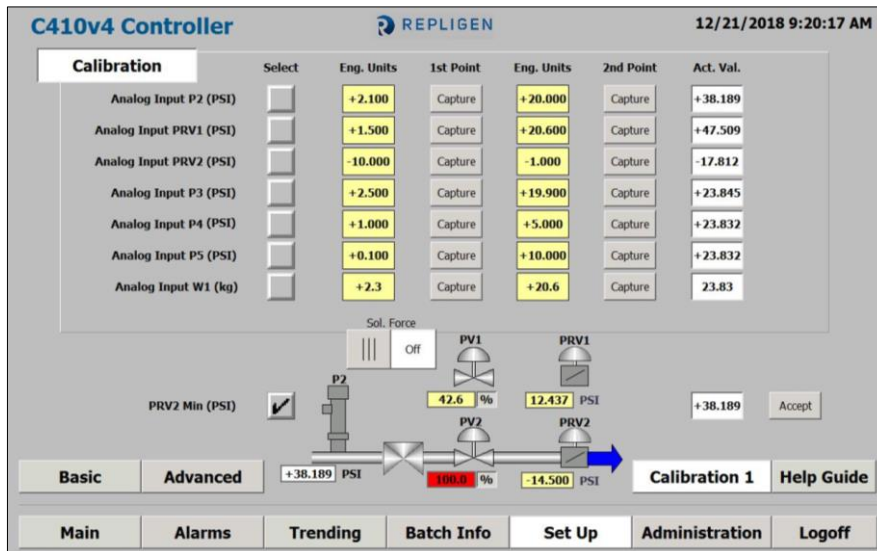

Analog Input Configuration/Calibration: Only accessible to the Administrator and Engineer Login. The Analog Input Configuration/Calibration screen allows for the set-up of analog inputs. For each analog input the Administrator and Engineer will be able to configure the Engineering Units, the minimum engineering value, the maximum engineering value, and perform a two-point calibration (or linear scaling).

Table 8. Calibration screen display parameters

Field	Description
Entries on screen	Field entries: (14) Eng. Units, PV1, PRV1, PV2, PRV2
Eng. Units (14 places)	Enter the minimum engineering value for the selected analog input to the left of 1 st point; and the maximum value to the left of 2 nd point
Actual Value	Displays input value after the two-point calibration is performed.
PV1	Displays current position set point of flow proportional valve (0 - 100%)
PV2	Displays current position set point of exhaust proportional valve (0 - 100%)
PRV1	Displays current setting of automatic pressure regulator (0 - 35psi)
PRV2	Displays current setting of automatic exhaust regulator (-15 - 0 psi)
P2	Displays current pressure between controller and diaphragm pump (PSI)

Button	Description
Analog Input select	This button enables which of the Analog Inputs is selected for 2-point linear scaling.
Capture (1st Point)	This button captures the raw input value for the first point for the selected analog input.
Capture (2nd Point)	This button captures the raw input value for the second point for the selected analog input
Accept settings	This button will enable the new settings. Exiting the screen without accepting the settings will discard them. It is only visible after both 1 st point and 2 nd point have been captured. Applies to calibrating (scaling) the above 7 analog inputs.
Sol. Force	Allows manual control of flow control valve, SOL1; with that controlling flow direction of pneumatic system.
PRV2 Min Check box	While checked, the following is set: 1. The solenoid is set to the vacuum position 2. PV2 is commanded to 100% 3. PRV2 is commanded max vacuum The readout of the P2 sensor is displayed to the right
Accept	This button provides the measured P2 value to the controller (also displayed on the advanced Set-up screen) as the minimum PRV2 setting. Pressing this accept button also unchecks the above check box, setting the solenoid, PV2 and PRV2 to their previous values.
Basic Set-up	Press to switch to Basic Set-up screen
Advanced Set-up	Press to switch to Advanced Set-up screen
Help Guide	Press to switch to Start-up Guide screen
All Primary	All Primary screen buttons are displayed to navigate to those screens

The pump must be off with the controller in Local mode to reach this screen.



WARNING: Do not turn the Sol. Force to the ON position when the XCell ATF® Device is connected to the Pneumatic Enclosure (with air pressure utility). Doing so may over expand the diaphragm causing potential breach.

Figure 15. Trending screen

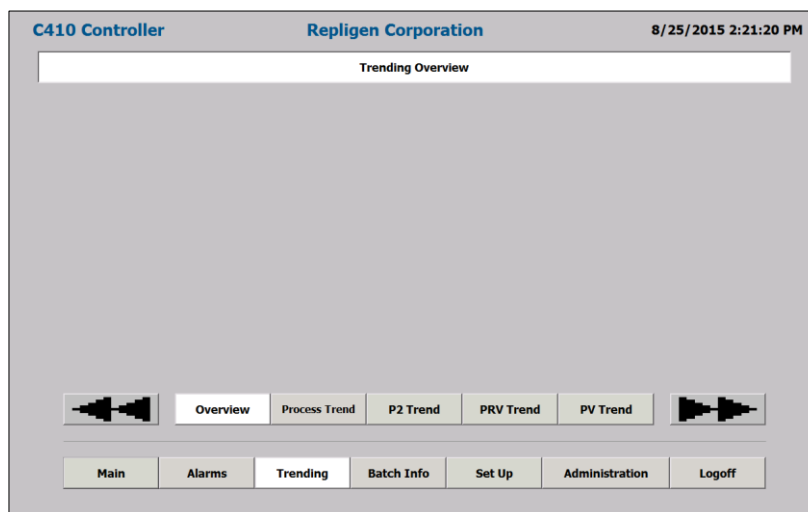

The Trending screen displays an Overview screen from where the following trends are selected.

Figure 16. Process Trend screen

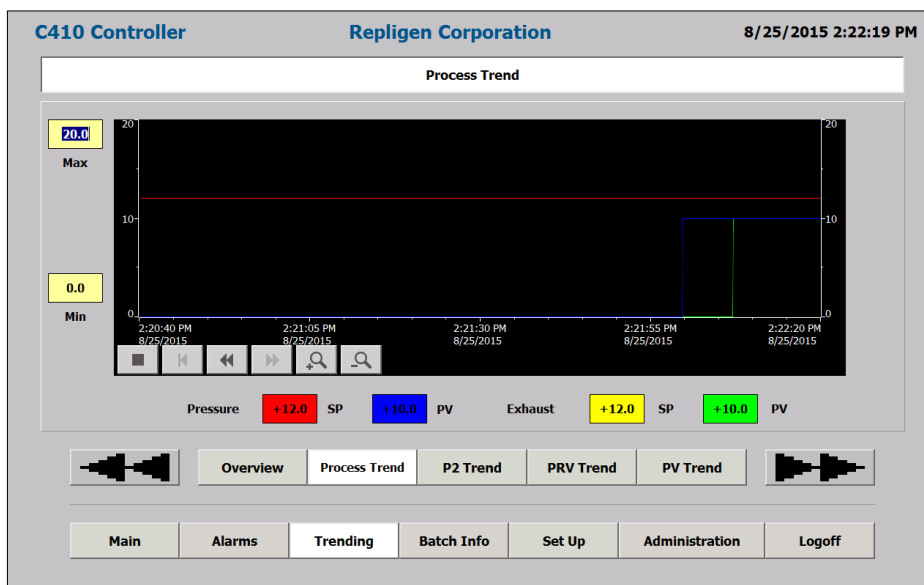

This screen monitors, in real time, the Flow and Exhaust Set Points and Process Values in liters per minute (LPM).

The Process Trend screen monitors, in real time, the Flow and Exhaust Set Points and Process Values in LPM.

Table 9. Process Trend screen control options

Field	Description
Max	Enter maximum value for the chart Y axis
Min	Enter minimum value for the chart Y axis

Button	Description
	Scrolls back to the beginning of the trend recording. The start values, with which the trend recording started, are displayed
	Zooms into the displayed time section
	Zooms out of the displayed time section
	Scrolls back one display width
	Scrolls forward one display width
	Starts or continues trend recording
	Stops trend recording
Primary screens	All Primary screen buttons are displayed to navigate to those screens

Figure 17. PV, PRV, P2, P3, P4, P5, W1 Trend screen



These screens monitor, in real time, the specific analog signal. Trend buttons select trend to display see [Table 9](#).

Weight trend

Available in the Trending screen.

During the XCell ATF® Device cycle, the weight of the filtration assembly changes in response to the liquid flow to and from diaphragm pump. The weight profile is directly proportional to the position of the diaphragm within the diaphragm pump which drives how much liquid is in the diaphragm pump. This provides useful real time information on the position of the diaphragm within the diaphragm pump, which is indicative of the cycle time and the effectiveness of the pressure and vacuum cycles.

That information may be used to:

- Monitor if the diaphragm cycles its full stroke
- Display the position of the diaphragm in the diaphragm pump

The operator can view the XCell™ C410:V4B Controller Warnings and Alarm conditions. All Alarms/Warnings are displayed with Time/Date stamping and full description of condition. Both Alarms and Warnings will activate the audible horn located inside the XCell™ C410:V4B Controller

cabinet. An Alarm condition will automatically stop the pump cycling action, while a Warning condition allows the pumping cycling action to continue. Warning and Alarm conditions are described in the following section.

Table 10. Alarm display parameters

Field	Description
Time	Indicates time of alarm
Date	Indicates date of alarm
Text	Describes alarm

Button	Description
Horn Acknowledge	Press to turn off horn
	Select Highlight Warning/Alarm message and press to remove
All Primary	All Primary screen buttons are displayed to navigate to those screens

Table 11. Two (2) pump controller status relay states

XCell ATF® Device states	State #	Relay #1	Relay #2
Power Off/Alarm	A	Off	Off
Power On/Standby	B	Off	ON
Power On/Running	C	On	On
Power On/Warning	D	On	Off

Table 12. Two (2) pump interlock relay states

Harvest Pump state	Relay #3	Relay #4
Active	On	On
Not Active	Off	Off

An isolated Form C contact for each relay is provided for the end user to connect to any remote monitoring system. The Harvest pump is activated to Run mode, only and only if Relay #1 is ON, i.e., in Power On/Running state #C or Power On/Warning state #D.

The following is a list of the XCell™ C410:V4B Controller warnings that can occur during normal operation:

- Flow Set Point cannot be reached. P-Flow Regulator (PV1) above maximum operating setting.
- Flow Set Point cannot be reached. P-Flow Regulator (PV1) below minimum operating setting.
- Exhaust Set Point cannot be reached. E-Flow Regulator (PV2) above maximum operating setting.
- Exhaust Set Point cannot be reached. E-Regulator (PV2) below minimum operating setting.
- P2 Pressure below LoLo limit.

The following is a list of XCell™ C410:V4B Controller alarms that can occur during normal operation:

- XCell ATF® Device warning has not been acknowledged. XCell ATF® Device function halted.
- Main power loss (120/220) while diaphragm pump was running.
- P2 Pressure above HiHi limit

5.6 Admin

Great care should be exercised when altering parameters located on the screens described in this section. Only accessible to the Administrator who can navigate to the following screens:

Figure 18. Users

User	Password	Group	Logoff time
Admin	*****	Administrators	5
Eng1	*****	Engineers	5
Oper1	*****	Operators	5
PLC User	*****	Unauthorized	5

The screen allows creation/amending of User ID's and passwords.

There are three (3) levels of security:

1. Administrators
2. Engineer
3. Operator
 - One (1) Administrator Level User [Admin]
 - Several Engineer Level User [Eng1], [User22], [User23], [User24], [User76]
 - Several Operator Level User [Oper1], [User1], [User10], [User11], [User21]

Only administrators have security access to add/edit/delete all other User ID's by touching the appropriate fields.

Each User ID includes a field for Logoff time (in minutes). When the time of inactivity is reached, the current user will automatically be logged off. Access to other screens will prompt the user to log in again. To disable this feature, a time value of 0 can be entered into the Logoff time field.

Table 13. Administration screen display parameters

Field	Description
User	Enter User ID
Password	Enter password
Group	Enter Group No. to define security level
Log Off Time	Set the amount of time in minutes before current user is automatically logged out. A value of zero will disable this feature

Button	Description
All Primary	All Primary screen buttons are displayed to navigate to those screens
Basic	Navigates to Admin basic screens

Each level of security allows different levels of access to the XCell™ C410:V4B Controller control functionality please refer to [Appendix 2](#) for details.

Figure 19. Basic

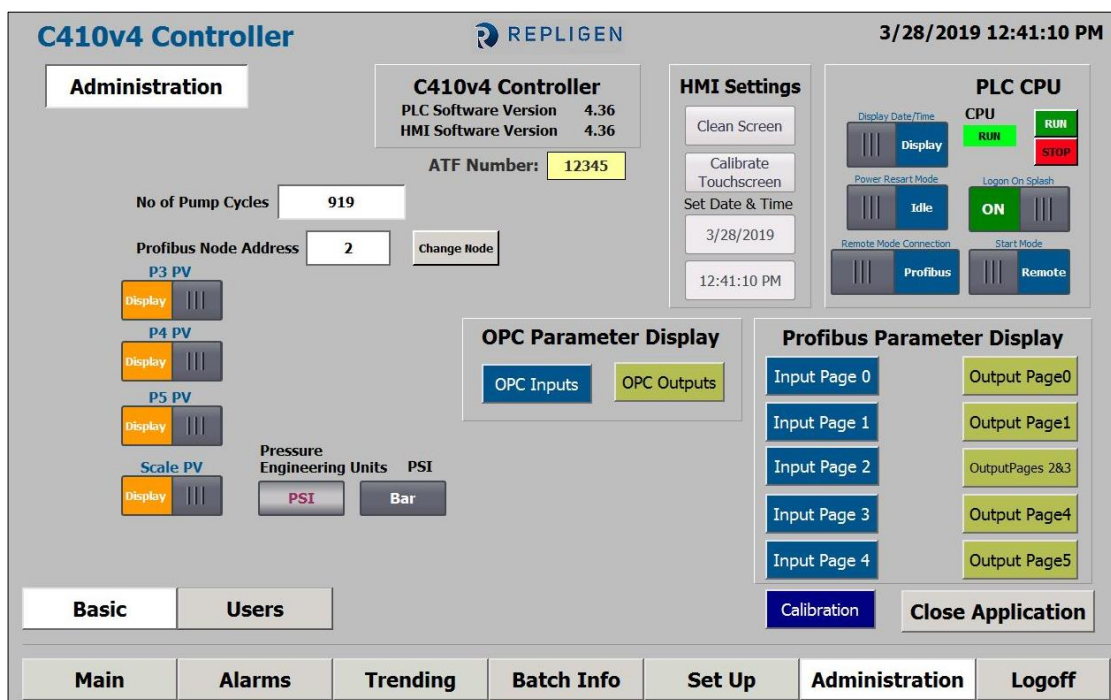

Table 14. Administration screen display parameters

Field	Description
Software Version	Both PLC 4.36 (as shown) and HMI 4.36 (as shown) version numbers are displayed
XCell ATF® Device Number	Numerical entry allowing end users to identify XCell™ C410:V4B Controller
Number of Pump Cycles	Total number of pump cycles of all batches since reset
Profibus Node Address	Defaulted to 2. This entry field allows for selecting alternate node addresses
Pressure Engineering Units	Either PSI (as shown) or Bar
Display Date/Time	Either Display (as shown) or Hide. Selecting Hide removes the Date/Time display from all screens. This was installed in the event that the system time had lost time synchronization with a central manufacturing system, but customer request. <i>This value is retained during a power loss of the controller, making this selection permanent.</i>
CPU	Either RUN (as shown) or Stop

Field	Description
Power Restart Mode	Either Idle (as shown) or Resume. This directs controller activity upon controller power up. Resume will direct the controller to attempt to continue XCell ATF® pumping [after complete boot up] at the last known flow setpoint. Idle will not attempt to start the pump. <i>Repligen recommends leaving this idle for safety reasons.</i>
Logon On Splash	Either ON (as shown) or OFF. Selecting OFF will not display the Logon button on the Initial screen. This retained value should only be set to OFF if users expect complete remote operations. Once this is set to OFF, it cannot be returned to the on state except by Repligen personnel. <i>Repligen recommends leaving this in the factory set state.</i>
Remote Mode connection	Either Profibus (as shown) or OPC. This slider switch selects which type of connection is in command the PLC when in remote mode. All soft outputs are provided to both sources and may be read from the PLC, however only one of these shall be in command of the PLC.
Start Mode	Either Remote (as shown) or Local. This slider switch selects whether the system will start-up in (after power up) in remote control or local (HMI) control.

Button	Description
Clean Screen	Siemens Touch Panel (HMI) utility which temporarily deactivates the touch screen. Intended to allow cleaning of the screen without activating any buttons
Calibrate Touchscreen	Siemens Touch Panel (HMI) utility fine tunes the touch locations on the screen
Set Date	Allows direct date setting without closing the XCell ATF® application
Set Time	Allows direct time setting without closing the XCell ATF® application
Display Date/Time	Selector switch: Described in Field Description
CPU RUN	Places the PLC in RUN mode
CPU STOP	Places the PLC in STOP mode
Power Restart mode	Selector switch: Described in Field Description
Logon On Splash	Selector switch: Described in Field Description
Remote Mode Connection	Selector switch: Described in Field Description
Start Mode	Selector switch: Described in Field Description
Change Node	Changes the Profibus node to the value entered to the right. This should only be changed by authorized personnel
P3 PV	Selector switch: Display or Hide Input value on Main screen
P4 PV	Selector switch: Display or Hide Input value on Main screen

Button	Description
P5 PV	Selector switch: Display or Hide Input value on Main screen
Scale PV	Selector switch: Display or Hide Input value on Main screen
PSI or BAR buttons	Only visible in local mode, when XCell ATF® Device pump is stopped, and no calibration activities are enabled. Select one to display alternate engineering units.
OPC Inputs	Displays user defined OPC input parameters, addresses and values
OPC Outputs	Displays pop-up screen of OPC output parameters, addresses and values
Input Page 0-4	Displays user defined Profibus inputs by page of parameters, addresses, values, and feedback values
Output Page 0-5	Displays Profibus outputs by page of parameters, addresses and values
Calibration	Displays calibration settings in the PLC
Users	Navigate to the Users screen
All Primary	All Primary screen buttons are displayed to navigate to those screens
Close Application	Exits the HMI program; allow access to Windows CE settings screen

5.7 Batch info

Display batch information is on the following screens:

Figure 20. Batch Info Overview screen

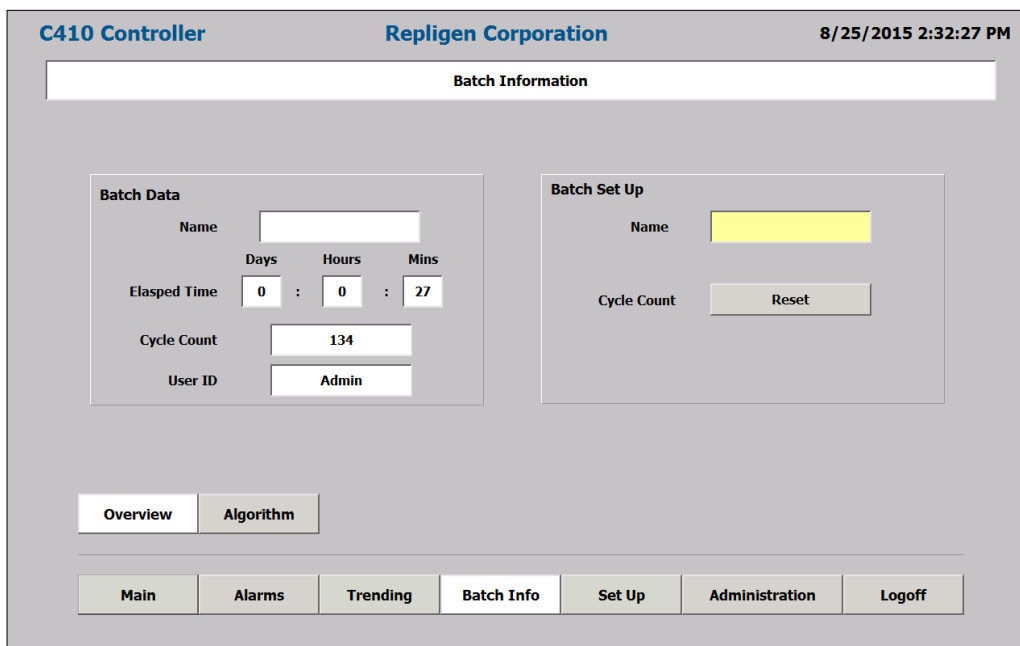
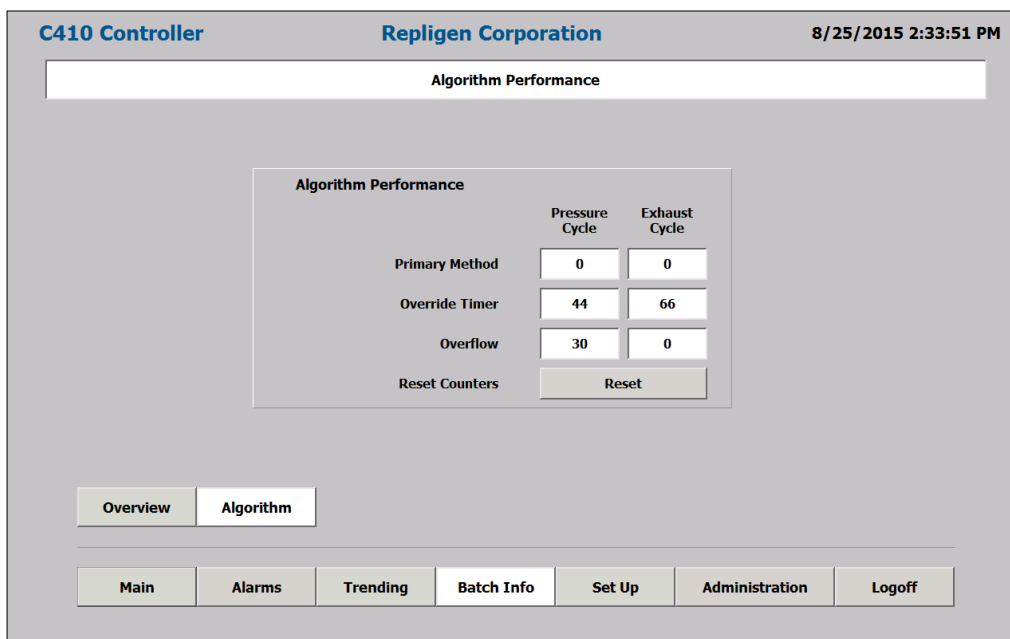

Table 15. Batch Info Overview screen display parameters

Field	Description
Batch Data	Displays current Batch information
Elapsed Time	Displays Elapsed time of current batch run. Time is reset by changing Batch Name
Cycle Count	Displays Diaphragm pump Cycle count of current batch run
User ID	Displays Users ID: Engineer or Administrator
Batch Set-up	Set Batch Name and reset Cycle count
Name	Click on field to change batch name
Button	Description
Cycle Count - Reset	Resets cycle count to zero in Batch Data field
Algorithm	Navigates to Batch Algorithm screens
All Primary	All Primary Screen buttons are displayed to navigate to those screens

Figure 21. Algorithm



The XCell ATF® Device cycle change can occur by either of three algorithms. The screen tracks cycle change algorithm performance. The three algorithms are:

1. Set Point - normal process based on Set-up parameters.
2. Overtime - when P2 Set Point is not achieved in within 120% of calculated time.
3. Overflow - When P2 reaches P1 (+/- OSP) within the set delay time.

Table 16. The Batch Info Algorithm screen display parameters

Field	Description
Algorithm performance	Tracks cycle change mechanism
Primary Method	Shows cycle count triggered by Set point method, tracks Pressure cycle and Exhaust cycle counts
Overtime	Shows cycle count triggered by Overtime, tracks Pressure cycle and Exhaust cycle counts
Overflow	Shows cycle count triggered by Overflow, tracks Pressure cycle and Exhaust cycle counts

Button	Description
Reset Count	Resets all counts by Set Point, Overtime and Overflow to zero
Overview	Navigates to Batch Overview screens
All Primary	All Primary screen buttons are displayed to navigate to those screens

5.8 Logoff

On user logoff, the controller continues to operate normally. A user must log back on to make changes to setting.

5.9 Start-up

Assembly of the XCell ATF® Device is described in the following sections. This section provides a startup guide for an XCell ATF® Device connected to a bioreactor and ready for use, with the following general conditions:

- An XCell ATF® 6 Device is used in this example.
- An XCell ATF® Device flow of 12L/min is required.
- Bioreactor pressure is 0.0 psi
- Δ height between pump midpoint and vessel liquid level is 0 cm
- Regulated air pressure set to 35 psi
- Vacuum source connected

Following Logon and entry of batch Information, go to the Set-Up screen. Go to the basic Set-Up screen and enter the following field values:

Field	Value
Controller Set-up	
Pump Model No	Select XCell ATF® 6 Device
Control Mode	Select Flow
Slope Function enable	Do not enable
Bioreactor pressure	0
Δ height (cm)	0
Alarm Delay(min)	1
Alarm Set Points	
HiHi Alarm Set Points	7 psi
LoLo Alarm Set Point	-7 psi
Alarm Delay (x10 msec)	50 for both
Pump Parameters	
P-Pressure Offset (psi)	0.5
E-Pressure Offset (psi)	-0.5
P-Delay (%)	70
E-Delay (%)	70
P-Overtime (%)	120
E-Overtime (%)	120
P-PV Step Size (%)	3
E-PV Step Size (%)	3

Press accept changes.

Go to the Advanced Set-up screen and enter the following field values:

Field	Values				
User Set point range	XCell ATF® 4 Device	XCell ATF® 4MC Device	XCell ATF® 6 Device	XCell ATF® 10 Legacy Device	XCell ATF® 10 Device
Max P-FLOW (LPM)	10	10	20	80	100
Min P-FLOW (LPM)	1	1	5	20	20
Max E-FLOW (LPM)	10	10	20	80	100
Min E-FLOW (LPM)	1	1	5	20	20
PV1 Max (%)	95				
PV1 Min (%)	5				
PV2 Max (%)	95				
PV2 Min (%)	5				
Output (CV) limits					
PRV1 Max (psi)	25				
PRV1 Min (psi)	1				
PRV2 Max (psi)	-1				
PRV2 Min (psi)	-12.5				

Note: Min and Max E and P Flow setpoints do not change to Time values when Control Mode is changed to time.

Press Accept changes.

Go to the Main screen entry:

Field	Values
P-FLOW Status	
SP (Lpm)	12
E-FLOW Status	
SP (Lpm)	12

Note that PV and PRV fields are populated.

Check all XCell ATF® Device connections.

Press start.

Once the system begins to cycle, Note the following:

- The deviation of Actual Flow from Set Flow. The deviation between the two should be small. Following a few cycles, the Actual and Set Flows should be similar.

Note: If in P-Flow block, Actual Cycle Time field is flashing Orange or Red; the same for the E-Flow block, Actual Cycle Time field. If not flashing, the system is functioning properly. If flashing remains, stop the controller and recheck all entries and connections than restart.

If problem persists, check the following:

- The ΔP between PRV1-P2 should be greater than P-Pressure Offset and ΔP between PRV2-P2 should be less than E-Pressure Offset. If not, manually lower PV in small increments.
- Flow is too rapid- A flow that is too rapid during the Exhaust Cycle can be readily detected on the P2 trend by a rapid decline in pressure following a stable pressure profile. (The Pump exhausts too rapidly followed by a rapid pressure drop). Decrease PV2 or PRV2 to decrease flow as a corrective measure.

- c. Select the P2 trend in the MAIN screen and observe P2 profile, the P-Pressure Offset and the E-Pressure Offset should be apparent.
- d. Any adjustments in P2 trend on the Main screen are performed from the P2 Trend screens.

5.10 Examples

The XCell ATF® Device process control settings will depend on the process requirements. Each user or process may have its own unique requirements. Hopefully, the example provides a guideline to assist the users in selecting and optimizing operating conditions.

When working with an XCell ATF® Device connected to an unpressurized vessel, refer to [Figure 1](#) for an overview of positioning the filtration assembly, Pneumatic Enclosure and Electronics Enclosure relative to the bioreactor.

Example 1

Using an unpressurized bioreactor with an XCell ATF® 6 Device:

When using a bioreactor that cannot be pressurized such as a glass vessel or a disposable vessel, i.e., SUB, the connection between the Filtration assembly and the SUB will most likely not be an SIP type connection shown in [Figure 1](#). Placement of the Filtration assembly and controller relative to the bioreactor will, however, not change significantly.

Using a vessel that cannot be pressurized, both pressure and vacuum services are needed. See Utility Requirements, [Table 1](#).

Repligen offers custom, disposable connections to most commercial SUBs. The connection procedure between the filtration assembly and vessel are provided separately.

Start

1. Connect the filtration assembly to bioreactor per separate instructions.
2. Place the Pneumatic Enclosure in proximity of the filtration assembly.
3. Connect signal cable between Electronics Enclosure and Pneumatic Enclosure.
4. Connect Electronics Enclosure to an appropriate electrical power source
5. Connect the air line, exhaust line and pump line to their respective ports on the Pneumatic Enclosure. Do not connect the pump line from the XCell™ C410:V4B Controller to the diaphragm pump at this point.
6. Power ON the Electronics Enclosure. Wait for system to boot up and display the XCell ATF® Device Initial screen.
7. After Logon, the Main screen is displayed. Proceed to the Set-up screen.
8. Enter settings.

Note: XCell ATF® Device selection - Select XCell ATF® 6 Device. Note reactor pressure and Δ height-enter 0 and measured difference between Diaphragm pump clamp and vessel liquid level in cm.

1. Power up compressed air and vacuum services, confirm pressure and vacuum services are on by observing the respective pressure gauges.
2. Connect pneumatic pump line to diaphragm pump air filter.
3. Activate the P2 trend on the MAIN screen. (Any setting adjustments in the P2 screen are made from the P2 TREND screen).
4. Press the START button on the MAIN screen.
5. The XCell ATF® Device should begin cycling normally.
6. Observe for conditions described at the end of the last section.

Note: The air purge from the system after start of XCell ATF® Device. Note also the small up and down change in vessel liquid level, indicating XCell ATF® Device cyclic flow.

Changing flow rate:

To change flow rates, simply go to the main screen select P-Flow SP. Enter the new flow rate on the pop-up menu. Press Yes to accept current PV and PRV values or press Default to accept default PV and PRV values. Default is recommended when entering new flow rates. Follow similar procedures to change E-Flow SP. It is recommended to STOP the controller prior to change of flow rate. Following the change, re-START the controller. It will start with the diaphragm in the fully exhausted position.

Filtrate or Harvest:

Start the Filtrate (or Harvest) pump only after the XCell ATF® Device flow has stabilized. Stop the filtrate /harvest pump when stopping the XCell ATF® Device flow; accordingly, the XCell™ C410:V4B Controller provides relay outputs on the Electronics Enclosure for activating or deactivating a filtrate/harvest pump.

Please contact your local Account Manager from Repligen to obtain additional technical assistance with automation/integration related information.

6. Spectrum® Hollow Fiber Module (HFM) and diaphragm replacement

The following is a guideline for replacing a Spectrum® Hollow Fiber Module (HFM) or the diaphragm within the diaphragm pump. Since the procedures for replacing these parts are similar, a generalized description is provided. Where necessary, more specific references and descriptions will be provided.

Example 2

Replacing a HFM in filtration assembly connected to a pressure rated vessel:

Prerequisites: Steam is available and the HFM must be replaced in mid run in a sterile manner. Refer to [Figure 1](#).

6.1 Separating the filtration assembly from the bioreactor

1. Stop the XCell™ C410:V4B Controller.
2. Stop the filtrate /harvest pump.
3. Disconnect Diaphragm pump pneumatic line from the pump air inlet filter.
4. Close or disconnect compressed air and vacuum services from the Pneumatic Enclosure.
5. Disconnect any sensors from the Filtration assembly to Pneumatic Enclosure.
6. If necessary, remove the Pneumatic Enclosure from the proximity of the Filtration assembly.
7. Close and disconnect the filtrate line.

Disconnect the filtration assembly from the vessel as follows:

1. Securely close both bivalves connecting the Filtration assembly to the vessel.
2. Drain liquid from the connection. Optionally, purge the connection with water, steam or some other medium.
3. Disconnect the filtration assembly from vessel between the two bivalves.
4. Remove the filtration assembly to an appropriate work area, i.e., a sink.

6.2 HFM removal

1. Drain the system into an appropriately sized drain or waste vessel.
2. Remove all sensors from the filter housing.
3. Remove air inlet filter connected to the diaphragm pump and any other connections to the XCell ATF® Device.
4. Open the clamp connecting the Filter Housing to the diaphragm pump and separate.
5. Open the clamp connecting the Reducer to the Filter Housing and separate.
6. The HFM may then be removed from the Filter Housing by firmly pressing it from one end.
7. Remove the exposed O-ring at the exposed end of the HFM.

8. Press the HFM in the opposite direction to remove the HFM.
9. Prepare filter housing for cleaning and reuse or for cleaning and setting aside.

6.3 HFM insertion

Prior to use, HFM may require wetting with water or buffer. In general, prior to use, please read the separate Hollow Fiber Module Preparation Instructions that are included with every hollow fiber. There are different preparation methods depending on the module type purchased. Two types of HFMs are available for the XCell ATF® Device; accordingly, two types of Filter Housing are available:

- S-line housing for use with HFM with O-rings on the HFM ends for sealing against the housing inner diameter.
- I-line Housing for use with HFM with no attached O-rings. The O-ring is placed in a recess at the housing ends, between HFM and reducer (or diaphragm pump). Clamping the connection between reducer (or diaphragm pump) and the Filter Housing squeezes the O-ring effectively forcing the O-ring against the filter wall, effectively sealing the three parts.

Figure 22. Types of filter housings

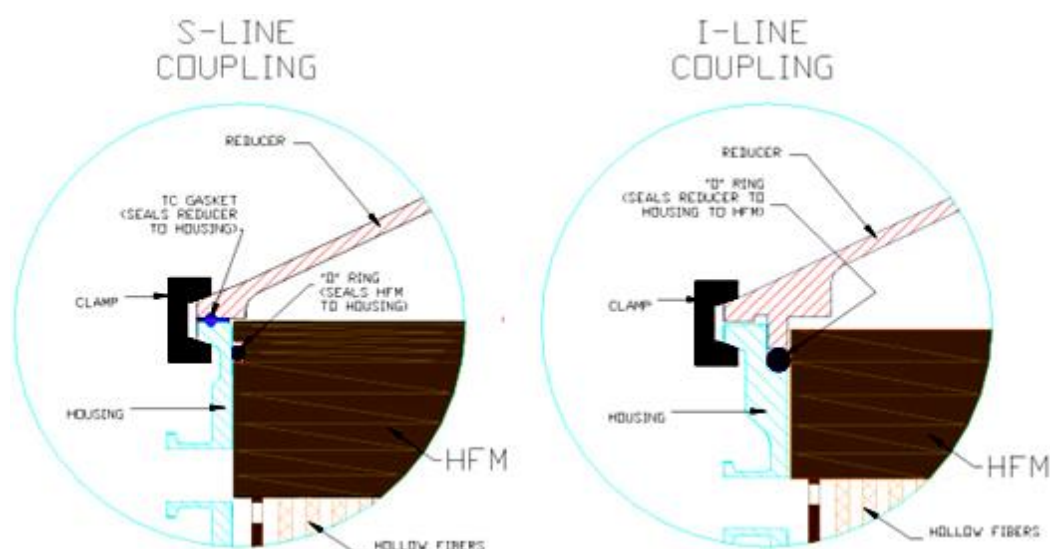

6.3.1 S-Line HFM insertion

1. Lay the filter housing horizontally and insert HFM (without O-rings) into the filter housing. Step 2 is to avoid damage to the O-ring during its insertion and sliding into the housing, to avoid crossing the harvest port opening during insertion, as the drain port is close to the housing end.
2. Expose HFM at the filter housing end distant to drain port, in proximity to the filtrate/harvest port.
3. Place an O-ring in the exposed HFM O-ring groove.
4. Press the HFM with O-ring firmly into the housing. Assure the O-ring is inserted smoothly and uniformly. Lubricate with WFI to facilitate this process.
5. Press until the HFM O-ring groove is exposed at the other end, the drain nozzle end.
6. Place 2nd O-ring on the exposed end.
7. Press the HFM back into the filter housing until both O-rings seal against the housing ID.
8. Assemble the system.

6.3.2 Line HFM insertion

1. Stand the filter housing vertically, with harvest port up.
2. Insert the HFM into the housing.
3. Insert one O-ring into the groove formed between HFM and filter housing end-ferrule wall.
4. Place the reducer onto the end, forcing the O-ring into the groove.
5. Clamp the reducer to the housing, the compressed O-ring is forced against the HFM. A seal is formed between the housing, reducer and HFM.
6. On the other end of the filter housing, Place the second O-ring into the formed groove between HFM and housing end-ferrule.
7. Carefully place the filter housing onto the diaphragm pump, forcing the O-ring deeper into the groove.
8. Clamp the filter housing to the diaphragm pump.
9. Assemble the XCell ATF® Device.

6.4 Screen Module replacement

If the screen module is being used, contact customerserviceUS@repligen.com at Repligen for replacement instructions.

6.5 Diaphragm replacement

Replacement or placement of a diaphragm within the diaphragm pump is part of the diaphragm pump assembly process which differs slightly among the XCell ATF® 4 Device, XCell ATF® 6 Device and XCell ATF® 10 Device.

Diaphragm replacement procedure for the XCell ATF® 4 Device, XCell ATF® 6 Device

Place cleaned diaphragm pump hemispheres, diaphragm, and pump clamp on a tabletop.

1. Place the PL pump hemisphere (hemisphere with a nozzle on the side) with the large opening in the upward position.
2. Place diaphragm, pointing down into the PL pump hemisphere with the nipple of the diaphragm orientated towards the ceiling. Assure the diaphragm gasket O-ring is positioned uniformly about the periphery of the pump O-ring groove.
3. Mate the PA-pump hemisphere, wide opening down, with the diaphragm in PL pump hemisphere. Assure the diaphragm gasket O-ring is positioned uniformly about the periphery of the PA O-ring groove.
4. The two hemispheres, with diaphragm in between, should be equally spaced.
5. Clamp the two hemispheres together.
6. Secure the diaphragm pump to the stand.

Diaphragm Replacement Procedure for the XCell ATF® 10 Device

1. The diaphragm within the diaphragm pump of the XCell ATF® 10 Device contains a short right-angle bend on the diaphragm periphery which mates with a counterpart groove in the PA pump hemisphere flange; therefore, for the XCell ATF® 10 Device, these two parts are assembled first. The two diaphragm pump hemispheres are assembled with the diaphragm pointing into the PL pump hemisphere.
2. Clamp the two hemispheres with the C-clamps, use the three long clamps first, and place 120 degrees to each other about the diaphragm pump periphery.
3. Uniformly and sequentially tighten the clamps, so the diaphragm is compressed evenly about the periphery of the two pump spheres.
4. Add the second set of short C-clamps as described above.
5. Add on the air inlet assembly to the Air inlet nozzle on the PA part.
6. Carefully invert the assembled pump sphere, so it stands on the long C-clamps.
7. One may place the pump onto its stand and/or proceed to assemble the entire system.
8. Torque Settings: ASME clamps: torque to 30 lb-ft, C-clamp assemblies: torque 20 - 25 lb-ft

6.6 Assembly

Fully assemble Diaphragm pump, Filter Housing, reducer and accessories and prepare for Pressure test. See, Pressure testing and sterilization.

6.7 Use

Following successful pressure testing and sterilization reconnect the filtration assembly to the bioreactor.

7. Sterilization



WARNING: These procedures refer to steam sterilization procedures. Steam is supplied at high pressure and at high temperature, over 100° C and can exceed 125° C. All parts of the filtration assembly are rapidly heated. Use similar precautions after removal of a system from an autoclave. Such heated systems should only be handled by qualified personnel taking all proper safety precautions.

7.1 Preparation of filtration assembly for autoclaving

Repligen recommends sterilization of the Filtration assembly by autoclaving. An appropriately sized autoclave is required. Contact Repligen for dimensional analysis of the autoclave. Sterilization of the Filtration assembly by autoclaving is one of the simplest methods to sterilize the system. In addition to the procedure below, please refer to the [XCell ATF® Device Filter Preparation and Autoclave Guide](#) for further details.

Pre-Autoclaving check list:

- Thoroughly wet the HFM with appropriate wetting agent
- Fully assemble filtration assembly as shown in [Figure 23](#).
- Perform a pressure test.
- Vent all ports blocked with 0.2-micron vent filters.

With both the filtrate and retentate sides vented, formation of pressure gradients across the hollow fibers membranes during sterilization is minimized. This assures free flow of steam into the unit and unobstructed pressure equilibration between all compartments within the unit; particularly, the filtrate and retentate sides are at the same pressure during the sterilization and cool down procedures.

Note: Use high-capacity vent filters to allow unobstructed high flow of steam into and from the system.

Figure 23. Filtration assembly prepared for autoclaving

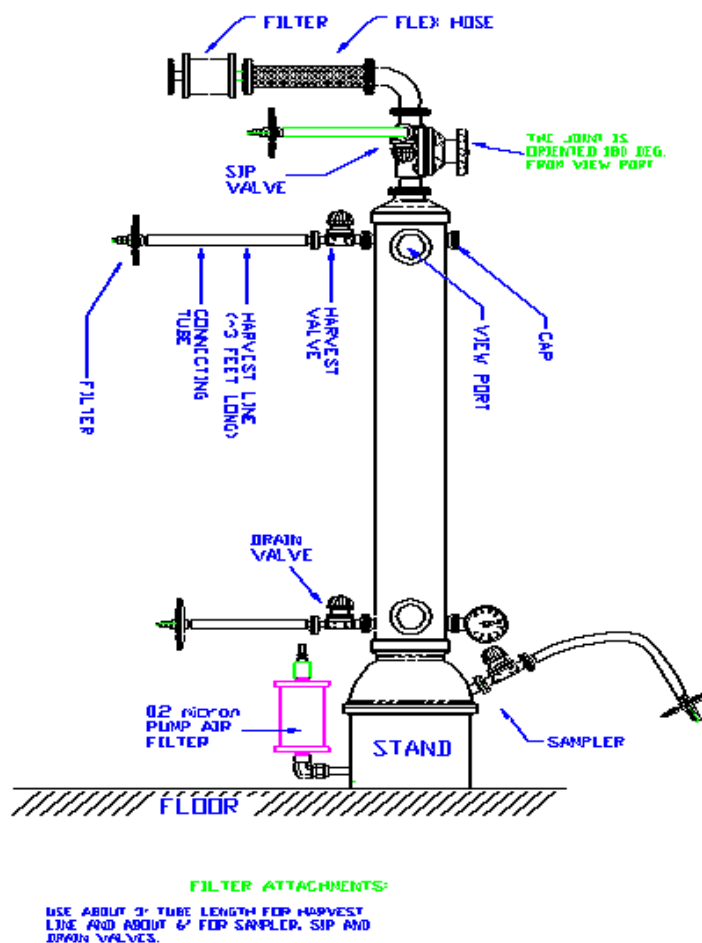

Close all unprotected ports.

- Depending on the size/configuration of the autoclave, the filtration assembly can be placed inside the autoclave either vertically or at an angle if necessary. Most autoclaves are not sufficiently tall for vertical placement.
- Use caution during the procedure so not to damage attached parts or tubing. Avoid kinking or stressing attached tubing.

7.2 Autoclave cycle

The XCell ATF® Device have been designed to be sterilized using an autoclave. The [XCell ATF® Device Filter Preparation and Autoclave Guide](#) provides detailed guidance on the entire procedure including the recommended filter integrity test procedures and specifications. The features of the recommended cycle are intended to ensure that the system will be effectively sterilized and that there is minimal thermal stress imposed on the hollow fiber cartridge that could lead to integrity failures.

The recommended cycle will require custom programming to incorporate a 90 minute preheat and 2 - 3 moderated prevac pulses to control the rate of temperature change within the cartridge to a rate of 1° C/min during the warmup. Repligen recommends that during the cycle development, several thermocouples should be positioned within the assembly to track the rate of temperature change and confirm that all positions are at 121 - 123° C for the duration of the sterilization section of the cycle. While autoclave conditions may vary based on requirements, the following are typical autoclave conditions for the filtration assembly. Please refer to the [XCell ATF® Device Filter Preparation and Autoclave Guide](#) for more details. The entire cycle may take 4 - 5 hours.

- The assembly should be placed in the autoclave at a 45° angle and be allowed to warm up for a period not less than 60 minutes with steam in the jacket, but not in the chamber.
- The active cycle will begin with a 5-minute purge where steam flows through the autoclave directly to the drain with minimal increase in chamber pressure.
- Secondly, there are 2 - 3 vacuum pulses with hold periods in between. These are critical to evacuate all the air within the assembly and ensure that there is a uniform temperature throughout the assembly prior to engaging the ramp up to reach the sterilization temperature.
- Follow with a 1-minute steam purge to about 6psi, and 108 ° C.
- Ramp up slowly, 1C/min, to sterilization temperature / pressure, of 121° C - 123 ° C / 16 psi.
- Sterilize for ~ 55 - 60 min.
- Ramp down slowly, with wet cycle exhaust protocol or 0.5 -1° C/min to 100° C.
- Allow the system to cool to 50° C before handling.

Open autoclave door, inspect the system, re-tighten all clamps (about ¼ turn).

Carefully remove the Filtration assembly from the autoclave.

Preferably, remove the Filtration assembly from autoclave into clean area.

Allow system to cool to room temperature in a clean area.

Pressurize system to about 5psi using sterile air source through one of the retentate vent filters. This step is optional.

After cooling down to room temp or after pressurization of system, close all valves.

The system may be stored until use.

7.3 Sterilization of Filtrate/Harvest line

The Filtrate/Harvest line with end filter will be sterile following autoclave. One must assure however that the Harvest line has been prepared with the appropriate tubing for use with the filtrate/harvest pump. One may also prepare the Filtrate/Harvest line, post autoclaving, using a tube welder. If a tube welder cannot be used, a disposable sterile coupling may be used.

8. Connection of the XCell ATF® Device to a bioreactor

Two types of connections between Filtration assembly and bioreactor are commonly available.

- Hard connection that can be sterilized by SIP
- Soft connection that uses single-use connectors such as the Kleenpak™, AseptiQuik®, Opta, ReadyMate™ DAC, Pure-Fit®, or other connectors now available from various vendors

8.1 Hard connection

The user should verify the following procedure:

- Typically used with stainless steel bioreactor systems where steam is readily available.
- This connection consists of at least two isolation bivalves ([Figure 1](#)). One bivalve attached to the vessel and the second bivalve attached to the Filtration assembly.
- A flexible hose between the main branches of the two valves.
- Steam inlet- The side valve on one of the bivalves may be used for steam inlet.
- Condensate-The side valve on the other bivalve is used for draining condensate. This valve should be the low point valve to assure complete condensate drainage. Attach a steam trap to this valve and connect to a drain.
- Close both Steam inlet and Condensate valves.
- Securely connect a regulated steam source to the steam inlet valve.
- Open steam service.
- Slowly open steam inlet valve.
- Slowly open steam condensate valve.
- Sterilize connection for about 20 min. at 121° C and ~16 psi.
- Cool-down.

- Close the condensate valve.
- Rapidly close the steam inlet valve and immediately open the main valve into the filtration assembly to minimize a pressure drop in the connection.

Note: that following SIP of the connection, the cool-down of the connection post SIP will generate a vacuum within the connection, which must be minimized.

9. Maintenance

9.1 Diaphragm

It is recommended that a new diaphragm be used with each new run. To avoid premature failure, it is important to ensure that the diaphragm is seated in the proper orientation. Use with aqueous liquids only. For use with other fluids contact Repligen for a technical discussion.

When used as instructed in this manual, the diaphragm is designed to last over 500,000 cycles.

9.2 Pump air inlet filter

The replacement of the pump air inlet filter will be determined by how the system is configured. If the air filter is autoclaved with the filtration assembly, it is qualified for 135° C, for 30 minutes, 3 times.

9.3 O-rings, gaskets and quick connects

The O-rings on the ventilation ports and quick connects (XCell ATF® 4 Device and XCell ATF® 6 Device) should be replaced every two or three runs. Replacement kits are available from Repligen. HFM Filter O-rings should be replaced with each new filter. For pump line, air supply, and vacuum source, all O-rings and gaskets should be replaced periodically. An approved lubricant may be used to facilitate coupling of parts containing an O-ring seal.

10. Appendix 1: Cycle vs flow rate

Table 17. Cycle time vs. flow rate

XCell ATF® Device	XCell ATF® 4 and 4 MC Device	XCell ATF® 6 Device	XCell ATF® 10 Device	XCell ATF® 10H Device
Pump volume (L)	0.4	1.2	5.1	6.0
Cycle time (sec)	Flow rate (L/MIN)			
4	6.0	18.8	76.5	90.0
6	4.0	12.5	51.0	60.0
8	3.0	9.4	38.3	45.0
10	2.4	7.5	30.6	36.0
12	2.0	6.3	25.5	30.0
14	1.7	5.4	21.9	25.7
16	1.5	4.7	19.1	22.5
18	1.3	4.2	17.0	20.0
20	1.2	3.8	15.3	18.0

11. Appendix 2: Access levels to the XCell™ C410:V4B Controller

There are 3 User levels. Most restrictive are Operators, then Engineers and finally Administrators. In general:

1. Operators have access to all functions except Algorithm review, Set-up and Administration. Operators and higher can start and stop XCell ATF® Device pumping.
2. Engineers have access to all functions except Administration. Engineers and higher can set flow set points, silence alarms [however, cannot remove alarms from the alarm list]
3. Administrators have unlimited access to all functions.

Table 18. Available permissions for user levels

User level	Screen	Controller function	Parameter	Permissions
Operator	Main	General Access	General	Access Upon Login
		Start/Stop	General Allowed	Allowed
		Remote/Local	Toggle	Allowed
		PFlow status	LMP SP	Not Allowed
			LPM PV	View only
			Sec Calculated	View Only
			Sec Actual	View Only
		E Flow status	LPM SP	Not Allowed
			LPM PV	View Only
			Sec Calculated	View Only
			Sec Actual	View Only
		P2 Trends	Enable	View Only (change range in trends)
		PV1	Input value	Not Allowed
		PRV1	Input value	Not Allowed
		PV2	Input value	Not Allowed
		PRV2	Input value	Not Allowed
		P2	General	View only
	Bioreactor	View	Display only	
	Batch	View	Display only	
	Runtime	View	Display only	
	Current User	View	Display only	
	Alarms	View Only	General	Allowed
		Silence Alarm	General	Not Allowed
		Clear Alarm	General	Not Allowed
	Trending	Process Trend	General	View and allowed to adjust Min and Max
		P2 Trend	General	View and allowed to adjust Min and Max
		PRV Trend	General	View and allowed to adjust Min and Max
		PV Trend	General	View and allowed to adjust Min and Max
P3 Trend		General	View and allowed to adjust Min and Max	
P4 Trend		General	View and allowed to adjust Min and Max	
P5 Trend		General	View and allowed to adjust Min and Max	
WI Trend		General	View and allowed to adjust Min and Max	

User level	Screen	Controller function	Parameter	Permissions	
Operator	Batch Info - Overview	Batch Data	Name	View Only	
			Elapsed time	View Only	
			Cycle Count	View Only	
			User ID	View Only	
	Batch Info - Overview	Batch Set-up	Name	View Only	
			Reset	View Only	
	Batch Info – Algorithm	General Access	General	No Access	
			Algorithm Performance	Primary Method	No Access
				Override Time	No Access
	Set-up Basic	Controller Set-up	Overflow	No Access	
			Pump Model	No Access	
			Control Mode	No Access	
			Alarm Delay	No Access	
			Slope Function Enabled	No Access	
			Bioreactor Pressure	No Access	
			Height Differential	No Access	
		Pump Parameters	Pressure Offset	No Access	
			Delay Time	No Access	
			Over Time	No Access	
			PV Step Size	No Access	
		Alarm Set Points	P2 Pressure	No Access	
			Alarm Delays	No Access	
		Set-up Advanced	User Set Point Ranges	Pressure Cycle Flow	No Access
	Pressure Cycle Flow Max			No Access	
	Pressure Cycle Flow Min			No Access	
	Exhaust Cycle Flow Max			No Access	
	Exhaust Cycle Flow Min			No Access	
	Output (CV) Limits		PV1(%)	No Access	
			PV2(%)	No Access	
			PRV1(psi)	No Access	
			PRV2(psi)	No Access	
			Accept Changes	No Access	
	Set-up Calibration	General Access	Discard Changes	No Access	
View			No Access		
Set-up Help	General Access	View Only	No Access		
Admin	Basic	General Access	Not Allowed		
	Users	General Access	Not Allowed		

User level	Screen	Controller function	Parameter	Permissions
Engineer	Main	General Access	General	Access Upon Login
		Start/Stop	General Allowed	Allowed
		Remote/Local	Toggle	Allowed
		P Flow Status	LMP SP	Allowed to Change
			LPM PV	View only
			Sec Calculated	View Only
			Sec Actual	View Only
		E Flow Status	LMP SP	Allowed to Change
			LPM PV	View Only
			Sec Calculated	View Only
			Sec Actual	View Only
		P2 Trends	Enable	View Only (change range in trends)
		PV1	Input value	Allowed
		PRV1	Input value	Allowed
		PV2	Input value	Allowed
		PRV2	Input value	Allowed
		P2	General	View only
		Bioreactor	View	Display only
		Batch	View	Display only
	Runtime	View	Display only	
	Current User	View	Display only	
	Alarms	View Only	General	Allowed
		Silence Alarm	General	Allowed
		Clear Alarm	General	Not Allowed
	Trending	Process Trend	General	View and allowed to adjust Min and Max
		P2 Trend	General	View and allowed to adjust Min and Max
		PRV Trend	General	View and allowed to adjust Min and Max
		PV Trend	General	View and allowed to adjust Min and Max
		P3 Trend	General	View and allowed to adjust Min and Max
		P4 Trend	General	View and allowed to adjust Min and Max
		P5 Trend	General	View and allowed to adjust Min and Max
		WI Trend	General	View and allowed to adjust Min and Max

User level	Screen	Controller function	Parameter	Permissions			
Engineer	Batch Info - Overview	Batch Data	Name	View Only			
			Elapsed Time	View Only			
			Cycle Count	View Only			
			User ID	View Only			
	Batch Info – Algorithm	Batch Set-up	General Access	Name	Allowed to Change		
				Reset	Allowed		
	Set-up Basic	Set-up Basic	Controller Set-up	View	Allowed		
				Algorithm Performance	Reset	Allowed	
					Pump Parameters	Pump Model	Allowed to Change
						Control Mode	Allowed to Change
						Alarm Delay	Allowed to Change
						Slope Function Enabled	Allowed to Change
						Bioreactor Pressure	Allowed to Change
						Bioreactor Prefix	Allowed to Change
						Height Differential	Allowed to Change
						Pressure Offset	Allowed to Change
						Delay Time	Allowed to Change
						Over Time	Allowed to Change
						PV Step Size	Allowed to Change
						P2 Pressure	Allowed to Change
	Alarm Delays	Allowed to Change					
	Set-up Advanced	Set-up Advanced	User Set Point Ranges	Alarm Set Points		Allowed to Change	
				Output (CV) Limits	Pressure Cycle Flow	Allowed to Change	
					Pressure Cycle Flow Max	Allowed to Change	
					Pressure Cycle Flow Min	Allowed to Change	
					Exhaust Cycle Flow Max	Allowed to Change	
					Exhaust Cycle Flow Min	Allowed to Change	
					PV1(%)	Allowed to Change	
					PV2(%)	Allowed to Change	
					PRV1(psi)	Allowed to Change	
					PRV2(psi)	Allowed to Change	
Accept Changes	Allowed to Change						
Discard Changes	Allowed to Change						
Set-up Calibration	Set-up Calibration	General Access	View	Allowed			
			Calibrate	Select			
			Reference Value	Input Value			
			Accept Calibration	General			
			PV1	Input value			
			PRV1	Input value			
			PV2	Input value			
			PRV2	Input value			
P2	General						
Engineer	Set-up Calibration	Solenoid	Toggle	Allowed			
	Set-up Help	General Access	View Only	Allowed			
	Admin	Basic	General Access	Not Allowed			
	Admin	Users	General Access	Not Allowed			

User level	Screen	Controller function	Parameter	Permissions
Administrator	Main	General Access	General	Access Upon Login
		Start/Stop	General Allowed	Allowed
		Remote/Local	Toggle	Allowed
		P Flow Status	LMP SP	Allowed to Change
			LPM PV	View only
			Sec Calculated	View Only
			Sec Actual	View Only
		E Flow Status	LMP SP	Allowed to Change
			LPM PV	View Only
			Sec Calculated	View Only
			Sec Actual	View Only
		P2 Trends	Enable	View Only(change range in trends)
		PV1	Input value	Allowed
		PRV1	Input value	Allowed
		PV2	Input value	Allowed
		PRV2	Input value	Allowed
		P2	General	View only
	Bioreactor	View	Display only	
	Batch	View	Display only	
	Runtime	View	Display only	
	Current User	View	Display only	
	Alarms	View Only	General	Allowed
		Silence Alarm	General	Allowed
		Clear Alarm	General	Allowed
	Trending	Process Trend	General	View and allowed to adjust Min and Max
		P2 Trend	General	View and allowed to adjust Min and Max
		PRV Trend	General	View and allowed to adjust Min and Max
PV Trend		General	View and allowed to adjust Min and Max	
P3 Trend		General	View and allowed to adjust Min and Max	
P4 Trend		General	View and allowed to adjust Min and Max	
P5 Trend		General	View and allowed to adjust Min and Max	
WI Trend		General	View and allowed to adjust Min and Max	
Administrator	Batch Info - Overview	Batch Data	Name	View Only
			Elapsed Time	View Only
			Cycle Count	View Only

User Level	Screen	Controller Function	Parameter	Permissions
			User ID	View Only
		Batch Set-up	Name	Allowed to Change
			Reset	Allowed
	Batch Info – Algorithm	General Access	View	Allowed
		Algorithm Performance	Reset	Allowed
	Set-up Basic	Controller Set-up	Pump Model	Allowed to Change
			Control Mode	Allowed to Change
			Alarm Delay	Allowed to Change
			Slope Function Enabled	Allowed to Change
			Bioreactor Pressure	Allowed to Change
			Bioreactor Prefix	Allowed to Change
			Height Differential	Allowed to Change
		Pump Parameters	Pressure Offset	Allowed to Change
			Delay Time	Allowed to Change
			Over Time	Allowed to Change
		Alarm Set Points	PV Step Size	Allowed to Change
			P2 Pressure	Allowed to Change
			Alarm Delays	Allowed to Change
	Set-up Advanced	User Set Point Ranges	Pressure Cycle Flow	Allowed to Change
			Pressure Cycle Flow Max	Allowed to Change
			Pressure Cycle Flow Min	Allowed to Change
			Exhaust Cycle Flow Max	Allowed to Change
			Exhaust Cycle Flow Min	Allowed to Change
		Output (CV) Limits	PV1(%)	Allowed to Change
			PV2(%)	Allowed to Change
			PRV1(psi)	Allowed to Change
			PRV2(psi)	Allowed to Change
			Accept Changes	Allowed to Change
			Discard Changes	Allowed to Change
	Set-up Calibration	General Access	View	Allowed
		Calibrate	Select	Allowed
		Reference Value	Input Value	Allowed
Accept Calibration		General	Allowed	
PV1		Input value	Allowed	
PRV1		Input value	Allowed	
PV2		Input value	Allowed	
PRV2		Input value	Allowed	
P2		General	View only	
Solenoid	Toggle	Allowed		

	Set-up Help	General Access	View Only	Allowed
Administrator	Set-up Help	General Access	View Only	Allowed
	Admin Basic	General Access	General Access	Allowed
		No. of Pump Cycles	Reset	Allowed
		Sol. Force	Off/On	Allowed
		Close Application	Access	Allowed
		PLC status	PLC run/stop	Allowed
		No. of Pump Cycles	Reset	Allowed
		Sol. Force	Off/On	Allowed
		Clean Screen	Access	Allowed
		Date/Time	Input Value	Allowed
		Pressure Units	Toggle PSI/Bar	Allowed (when in local mode)
		Logon Splash	Toggle	Allowed
		Profibus 1	Access	Allowed
		Profibus 2	Access	Allowed
		Profinet®	Access	Allowed
	Admin Users	General Access	General Access	Allowed
		User Password/ Maintenance	User	Allowed for all except Admin and PLC User
			Password	Allowed for all except for PLC User
			Group	Allowed for all but Unauthorized
	Logoff time		Allowed	

12. Appendix 3: Controller lists - Alarm, warning, inputs, and outputs

Table 19. Alarms/Warning list

Tag name	Description		Alarm		
			Enable	Condition	Delay
"DB1".ALARM_REG(0)	XCell ATF® Device Warning condition has not been reset within the alarm delay time, XCell ATF® Device function halted.	Pump is Running and Alarm Delay Timer Setpoint is Greater than Zero.	*See note	Number of minute(s). Determined by Alarm Delay parameter on Basic Set-up screen	Alarm, System Stop, Activate System Fault Warning Horn
"DB1".ALARM_REG(1)	Main Power Loss (120/220) while Pump was running	First Scan of PLC on Power Up.	On first scan Pump State is not 0	N/A	Alarm, System Stop, Activate System Fault Warning Horn
"DB1".ALARM_REG(2)	P2 Pressure Above HI HI Limit	Pump is running	P2 pressure is greater than or equal to the P2 Hi HI Pressure alarm setpoint.	P2 Hi Hi Set Point Alarm Delay in 10ms increments.	Alarm, System Stop Activate System Fault Warning Horn
"DB1".WARN_REG(0)	Flow Set Point cannot be reached. P-Flow Regulator (PV1) above maximum operating setting	Pump is running	$PV1 \geq PV1MAX$	N/A	Warning, Activate System Fault Warning Horn
"DB1".WARN_REG(1)	Flow Set Point cannot be reached. P-Flow Regulator (PV1) below minimum operating setting	Pump is running	$PV1 \leq PV1MIN$	N/A	Warning, Activate System Fault Warning Horn
""DB1".WARN_REG(2)	Exhaust Set Point cannot be reached. E-Flow Regulator (PV2) above maximum operating setting	Pump is running	$PV2 \geq PV2MAX$	N/A	Warning, Activate System Fault Warning Horn

Tag name	Description		Alarm		
"DB1".WARN_REG(3)	Exhaust Set Point cannot be reached. E-Regulator (PV2) below minimum operating setting	Pump is running	PV2 <= PV2MIN	N/A	Warning,
"DB1".WARN_REG(4)	P2 Pressure below Lo Lo Limit	Pump is Running	P2_PV <= Pressure Alarm Lo Lo Setpoint	P2 Lo Lo Set Point Alarm Delay in 10ms increments.	Warning Activate System Fault Warning Horn
"DB1".WARN_REG(5)	System Stop Pressed	Always	A Blue system stop buttons are pressed	N/A	Warning, Activate System Fault Warning

***Note:** "DB1".WARN_REG(0) is true, or "DB1".WARN_REG(1) is true, or "DB1".WARN_REG(2) is true, or "DB1".WARN_REG(3) is true, or "DB1".WARN_REG(4) is true.

Table 20. Input/Output list

Tag name	Description	PLC Tag address	Engineering			Valve Fail position	Real Time trend
			Range	Decimal places	Units		
PP1	System Stop	%I0.0	N/A	N/A	N/A	N/A	N/A
PP2	System Stop	%I0.1	N/A	N/A	N/A	N/A	N/A
-	Spare	N/A	N/A	N/A	N/A	N/A	N/A
-	Spare	N/A	N/A	N/A	N/A	N/A	N/A
-	Spare	N/A	N/A	N/A	N/A	N/A	N/A
-	Spare	N/A	N/A	N/A	N/A	N/A	N/A
-	Spare	N/A	N/A	N/A	N/A	N/A	N/A
-	Spare	N/A	N/A	N/A	N/A	N/A	N/A
-	Spare	N/A	N/A	N/A	N/A	N/A	N/A
-	Spare	N/A	N/A	N/A	N/A	N/A	N/A
-	Spare	N/A	N/A	N/A	N/A	N/A	N/A
-	Spare	N/A	N/A	N/A	N/A	N/A	N/A
-	Spare	N/A	N/A	N/A	N/A	N/A	N/A
-	Spare	N/A	N/A	N/A	N/A	N/A	N/A
PL1	System Stop Indicator	%Q0.0	N/A	N/A	N/A	N/A	N/A
HN1	System Fault Warning	%Q0.1	N/A	N/A	N/A	N/A	N/A
SOL1	Pump Inflate/Deflate Solenoid	%Q0.2	N/A	N/A	N/A	N/A	N/A
CR1	Pump Controller Status Relay #1	%Q0.3	N/A	N/A	N/A	N/A	N/A
CR2	Pump Controller Status Relay #2	%Q0.4	N/A	N/A	N/A	N/A	N/A
CR3	Pump Interlock Relay #3	%Q0.5	N/A	N/A	N/A	N/A	N/A
CR4	Pump Interlock Relay #4	%Q0.6	N/A	N/A	N/A	N/A	N/A
PL2	System Stop Indicator	%Q0.7	N/A	N/A	N/A	N/A	N/A
-	Spare	N/A	N/A	N/A	N/A	N/A	N/A
-	Spare	N/A	N/A	N/A	N/A	N/A	N/A
-	Spare	N/A	N/A	N/A	N/A	N/A	N/A
RAW_P2_PV_1	Pump Pressure	%IW96	Note 1 -44.7	1	PSI	N/A	Y
RAW_PRV1_PV_1	Inflation Pressure	%IW98	Note 1 0 - 40	1	PSI	N/A	Y
RAW_PRV2_PV_1	Deflation Pressure	%IW100	Note 1 -15	1	PSI	N/A	Y
RAW_AIW10_PV_1	Spare	N/A	N/A	N/A	N/A	N/A	N/A
RAW_P3_PV_1	Optional Pressure 3	%IW104	Note 1	N/A	PSI	N/A	Y
RAW_P4_PV_1	Optional Pressure 4	%IW106	Note 1	N/A	PSI	N/A	Y
RAW_P5_PV_1	Optional Pressure 5	%IW108	Note 1	N/A	PSI	N/A	Y
RAW_W1_PV_1	Optional Weight	%IW110	Note 1	N/A	LBS	N/A	Y
RAW_PRV1_CV_1	Inflation Pressure	%QW128	0-100	1	%	FC	Y
RAW_PRV2_CV_1	Deflation Pressure	%QW130	0-100	1	%	FO	Y
RAW_PV1_CV_1	Inflation Pressure Proportional	%QW132	0 - 40	1	PSI	N/A	Y
RAW_PV2_CV_1	Deflation Pressure Proportional	%QW134	-15	1	PSI	N/A	Y

Note 1: Depends on calibration.

13. Appendix 4: Profinet® communication

13.1 XCell™ C410:V4B Controller Profinet® set-up and connectivity

Profinet® Platform Infrastructure

The communication link between the Windows environment and the XCell™ C410:V4B Controller is based on the Profinet® platform. The Profinet® platform is an open Industrial Ethernet standard developed by the PROFIBUS Organization and is standard Ethernet (IEEE 802.3). The Profinet® platform communication protocol sends and receives data using the open Ethernet TCP/IP standard at a bandwidth of 100 Mbit/s and functions identical to traditional industrial Ethernet in providing real-time channel for time-critical communications (i.e., process data)

Configuration

The communications interface between the controller HMI and PLC is based on Profinet® (Industrial Ethernet) platform. The controller is factory set to the following IP settings:

IP Address	Subnet Mask	Default Gateway	
HMI 192.168.1.167		255.255.255.0	None
PLC 192.168.1.168		255.255.255.0	None

This factory default setting has the HMI and PLC on the same subnet allowing proper communications to take place. If ##### appears in input fields and the software version is not displayed on the administration screen, the HMI and PLC may not be properly connected, and the connection may need to be reset. See below for instructions on how to set IP Addresses and connections.

Set/Change IP Address of HMI

1. HMI IP Address setting:
 - a. Select settings from the start menu, select network and dial up connections, then select PN_X1.
 - b. From this interface, the IP Address, Subnet Mask and all other ethernet properties can be adjusted.
2. PLC IP Address setting:
 - c. Select settings from the start menu (or go back to the setting screen) and select Service and Commissioning.
 - d. Select IP config by pressing the right arrow to reveal the 5th tab.
 - e. From the Service and Commissioning screen, press the assign IP button.
 - f. On the following screen select network, scan and start. Scan is running appears at the bottom of the window.
 - g. After the scan is complete, the S7-1200 device should appear. Select the S7-1200 device and the device fields populate with the current configuration.
 - h. From this interface, the IP Address, Subnet Mask and all other ethernet properties can be adjusted.
 - i. Once the values have been entered, select device, download and IP to assign the address to the device. IP suite settings could be assigned appears at the bottom of the window.
 - j. Exit out of the assign IP.
3. Set Connection between HMI and PLC:
 - k. From the Service and Commissioning screen, press the set connection button.
 - l. On the following screen press the Find Online button. After the scan is complete, the S7-1200 device should appear. Select it, and the IP Address box below contains the PLC's address. It can also be entered manually.
 - m. Press OK to accept and close the window.
 - n. Press Save to set the connection. Save is successful appears at the bottom of the window.

- o. Close the window to exit.
 - p. Close the Service and Commissioning window.
 - q. Close the Settings window.
 4. Start the program again and ensure that ##### do not appear in the main screen fields.

14. Appendix 5: Profibus communication

The XCell™ C410:V4B Controller is capable of remote operation using a Profibus DP slave card that enables communication to the Profibus DP master (customer). To activate this control mode, the selector switch on the Administrator screen must be toggled to Profibus. See section Basic Administration screen (Remote Mode Connection) selector switch.

14.1 Remote Control Mode

It is possible to set the XCell ATF® Device to Remote Control Mode from the main screen. With the control mode set to Remote, the XCell ATF® Device uses parameters sent from the Profibus master. When set to Local parameters may be entered from the local Human Machine Interface. Instead of using the onboard HMI (operator interface), the Remote control mode is intended to allow another operator interface (provided by the end user) to control XCell ATF® functions, as well as receive feedback from the XCell™ C410:V4B Controller regarding the XCell ATF® status and data acquisition for historical purposes.

14.2 Input signals (from Master to XCell ATF® Device)

The master, a system with a PROFIBUS interface, for example, sends output data to a slave device (XCell ATF® Device) in its configuration, which becomes input for the XCell™ Controller. The input signals from Master to XCell ATF® Device are divided into different pages. The master must set a parameter to define which of the pages is being sent, using the SendingDataPage parameter (InputPage0, InputPage1, InputPage2, InputPage3, InputPage4). When the XCell ATF® receives a new value in SendingDataPage from the Master, a timer is started. After 500ms, the XCell™ C410:V4BController begins copying the values from the Profibus input to the parameters defined in Input Signals (from Master to XCell ATF® Device) tables (provided the system is in remote control mode and the selector switch is set to Profibus). Should a parameter (from the master) be changed without changing page, the value is copied immediately.

When programming commands to the XCell™ C410:V4B Controller, it is recommended that SendingDataPage value remain at the value of the most recently sent command page, until an operator interacts with the master's user interface, requesting a change to the XCell™ C410:V4B Controller state. Examples include Remote set-up, Remote Start, Remote Stop as discussed below. Further, it is recommended to set the SendingDataPage value to 3 or 4 (for infrequent calibration commands) only when XCell ATF® Device is not running, and Repligen service personnel specifically are required to perform calibration activities.

14.3 Output signals (to Master from XCell ATF® Device)

The slave device (XCell ATF® Device) provides output data, which becomes inputs for the master. The output signals from the XCell ATF® Device are divided into different pages. The master must set a parameter to define which of the pages is to be received, using the RequestedDataPage parameter (OutputPage0, OutputPage1, OutputPage2, OutputPage3, OutputPage4). When the XCell ATF® Device receives a new value in Requested Data Page from the Master, the XCell™ C410:V4B Controller begins copying the values from the parameters defined in Output Signals (from XCell ATF® Device to Master) tables to the Profibus outputs.

The master can continuously cycle (in a recommended 1 second interval) the RequestedDataPage parameter to receive all the output data from the XCell ATF® Device. The ActiveDataPage and ATF_Heartbeat is provided on every output page, so the master can continually monitor the communication integrity and verify the data page being provided.

14.4 Profibus configuration for DCS integration

The XCell™ C410:V4B Controller is configured as a slave Profibus node; at node address 2 (default). The Siemens CM-1242-5 Profibus DP slave module's baud-rate is detected automatically when connected to the DP network. It is configured not to exceed 1.5 Mbps and is tested at 187.5 kbps.

Profibus address can be changed from the HMI Admin screen (For HMI-enabled units only, black-box configured controller Profibus address is set at the factory). ProfiBus1 and Profibus2 options on the HMI display Profibus values in the PLC which can be accessed remotely. See Section 6.3 (F2) for details.

14.5 Black-Box configuration

Black-box configuration is similar to remote control mode but allows completely remote operation of the XCell ATF® Device with HMI disabled at the factory. Black-box configuration can be requested at time of ordering a new system.

14.6 Prerequisites

The XCell ATF® Device should be calibrated and connected to a Bioreactor or other vessel. The XCell ATF® Device should be in a Remote Control Mode.

14.7 Remote set-up

The master sends input parameters pages 1 and 2 to XCell ATF® Device or Set-up the parameters locally. The Start/Stop parameter should be 0.

14.8 Remote start

The master sends analog input parameters page 0 to XCell ATF® Device. Initially, the Start/Stop bit should be reset to 0. The master starts the filtration by setting the Start/Stop bit to 1. It is recommended that unless operator intervention is required, SendingDataPage should remain at 0.

14.9 Remote stop

The master stops the filtration by resetting the Start/Stop bit to 0. The XCell ATF® Device stops running. It is recommended that unless operator intervention is required, SendingDataPage should remain at 0.

14.10 Remote running

During a run it is possible to change all parameters remotely. If the XCell ATF® Device is changed from Remote Control Mode to Local Control Mode, it continues to run, and it is possible to stop the run from the HMI. If the filtration has been stopped locally and is then changed back to Remote Control Mode, it will not restart. To restart the filtration the master must reset the Start/stop bit to 0 and then back to 1.

14.11 System-stop

If the XCell ATF® Device is stopped by the System-stop (one of 2 blue buttons on either the Pneumatic Enclosure or Electronics Enclosure), and the System-stop is reset, the XCell ATF® will not restart until the master has to reset Start/stop to 0 and then set back to 1. System-stop is indicated

visually with the buttons illuminated and indicated via Profibus by OutputPage0.System Stop Active (%DB31.DBX366.5).

14.12 Calibration process

When not running, calibration activities can be performed. The master sends input parameters pages 3 and 4 to XCell ATF® Device or calibrate locally. As in Remote Set-up, the Start/Stop parameter needs to be 0.

Repligen recommends having a service technician perform calibration activities. Once loop calibration is initiated, it must complete the calibration process. There is currently no means to disable an enabled calibration without completing the process via remote commands. Only one input loop shall be calibrated at a time. Each loop shall be calibrated in its entirety by itself, without enabling (or initiating) the calibration of another loop. The process of calibration is a 2-point linear scaling process, where a technician first confirms all required utilities, external pressure gauge and loop wiring is connected. The following steps are performed:

1. An enable bit is momentarily asserted. Controller is enabled in calibration mode for a particular analog input.
2. Pneumatic devices are set to produce a minimum setting. The pressure in the system approaches the minimum value commanded. Pressure gauge reading is allowed to stabilize.
3. The pressure gauge reading is provided to the controller. A minimum capture bit is momentarily asserted.
4. Pneumatic devices are set to produce a maximum setting. The value on the pressure gauge is allowed to stabilize.
5. The pressure gauge reading is provided to the controller. A maximum capture bit is momentarily asserted.
6. Once both minimum and maximum points are captured, the linear scaling calculation can be performed by the PLC. This calculation is initiated by setting an accept bit (momentarily asserted). Controller performs the linear scaling calculation and resets the controller's internal calibration enable bit.

14.13 Calibration example

Technician calibrates the P2 pressure sensor.

1. Assert enable bit:
 - a. Set SendingDataPage = 3
 - b. Set InputPage3.P2_Cal_Enable = 1 until the OutputPage4.P2_Cal_Enable bit is received.
 - Wait for the RequestedDataPage to be equal to 4; since cycling through output data pages is recommended.
 - Examine OutputPage4.P2_Cal_Enable. When true.
 - c. Reset InputPage3.P2_Cal_Enable = 0.
 - d. Controller is enabled in calibration mode for P2 analog input.
2. Pneumatic devices are set to produce a minimum setting. (PV2=100%, PRV2=-5.00 PSI, Solenoid=0 [vacuum]).
 - a. While SendingDataPage is still equal to 3.
 - b. Set InputPage3.PV2_SP = 100. Confirmed by examining OutputPage2.PV2.
 - c. Set InputPage3.PRV2_SP = -5. Confirmed by examining OutputPage1.PRV2
 - d. Reset InputPage3.Force_Solenoid = 0. Confirmed by examining OutputPage4.Solenoid_Forced.
 - e. The pressure in the system approaches the minimum value commanded. Pressure gauge reading is allowed to stabilize.

Note: OutputPage0.P2_PV and OutputPage0.PRV2_PV should be within ± 0.5 PSIG of the value on the external pressure gauge.

3. Pressure gauge reading is provided to the controller.
 - a. Programmer provides a data entry location for technician to enter the pressure value.
 - b. While SendingDataPage is still equal to 3.
 - c. Set InputPage3.P2_P1_EU = the pressure value from the data entry location.
 - d. Set InputPage3.P2_P1_Capture = 1 until the OutputPage4.P2_P1_Captured bit is received.
 - Wait for the RequestedDataPage to be equal to 4; since cycling through output data pages is recommended.
 - Examine OutputPage4.P2_P1_Capture. When true.
 - e. Reset InputPage3.P2_P1_Capture = 0; the minimum capture bit is momentarily asserted.
4. Pneumatic devices are set to produce a maximum setting. (PV1=100%, PRV1=20.00 PSI, Solenoid=1 [pressure or air]).
 - a. While SendingDataPage is still equal to 3.
 - b. Set InputPage3.PV1_SP = 100. Confirmed by examining OutputPage1.PV1.
 - c. Set InputPage3.PRV1_SP = 20. Confirmed by examining OutputPage1.PRV1.
 - d. Set InputPage3.Force_Solenoid = 1 Confirmed by examining Outputpage4.Solenoid_Forced.
 - e. The pressure in the system approaches the maximum value commanded. Pressure gauge reading is allowed to stabilize.

Note: *OutputPage0.P2_PV and OutputPage0.PRV1_PV should be within ± 0.5 PSIG of the value on the external pressure gauge.*

5. Pressure gauge reading is provided to the controller.
 - a. Programmer provides another data entry location for technician to enter the pressure value.
 - b. While SendingDataPage is still equal to 3.
 - c. Set InputPage3.P2_P2_EU = the pressure value from the data entry location.
 - d. Set InputPage3.P2_P2_Capture = 1 until the OutputPage4.P2_Cal_Enable bit is received.
 - e. Wait for the RequestedDataPage to be equal to 4; since cycling through output data pages is recommended.
 - Examine OutputPage4.P2_P2_Capture. When true.
 - f. Reset InputPage3.P2_P2_Capture = 0; the maximum capture bit is momentarily asserted.
6. Assert accept bit:
 - a. While SendingDataPage is still equal to 3.
 - b. Set InputPage3.P2_Accept = 1 until the OutputPage4.P2_Accept bit is received.
 - Wait for the RequestedDataPage to be equal to 4; since cycling through output data pages is recommended.
 - Examine OutputPage4.P2_Accept. When true.
 - c. Reset InputPage3.P2_Accept = 0.
 - d. Controller performs the linear scaling calculation and resets the controller's internal calibration enable bit.
7. Clean up: After all calibration activities are complete, be sure to perform the following:
 - a. Reset parameters that were set during the calibration process.
 - b. Set SendingDataPage = 0 to prepare for next XCell ATF® run commands.

14.14 Profibus input signals (from Master to XCell™ ATF Controller)

The following parameters can be sent from Profibus Master to command the XCell ATF®.

Table 21. Input Page 0

Profibus Address		Tagname plc in DB31		PLC Address	Definition	Units	Data type
Byte #	Bit #	Structure	Tagname in structure				
0	0	InputPageX	PB_ATF_START_STOP	%DB31.DBX128.0	Start/Stop		Byte
	1	InputPageX	PB_ATF_Ack_Alarms	%DB31.DBX128.1	Acknowledge Alarms		
	2	InputPageX	PB_Reset_Counters	%DB31.DBX128.2	Reset Algorithm Counters		
	3	InputPageX	PB_ATF_Control_Mode	%DB31.DBX128.3	Control Mode		
	4	InputPageX	PB_ATF_Slope_Enabled	%DB31.DBX128.4	Enable Slope Function		
	5			%DB31.DBX128.5			
	6			%DB31.DBX128.6			
	7			%DB31.DBX128.7			
1		InputPageX	RequestedDataPage	%DB31.DBW130	Requested Data Page		Int-16
2							
3		InputPageX	SendingDataPage	%DB31.DBW132	Sending Data Page		Int-16
4							
5		InputPage0	ATF_Connected_Bioreactor	%DB31.DBW134	XCell ATF® Connected Bioreactor		Int-16
6							
7		InputPage0	SpareBytes1[0]				Byte
8			SpareBytes1[1]				Byte
9			SpareBytes1[2]				Byte
10			SpareBytes1[3]				Byte
11			SpareBytes1[4]				Byte
12			SpareBytes1[5]				Byte
13			SpareBytes1[6]				Byte
14		InputPage0	PFLOWSP	%DB31.DBD144	Pressure Flow Setpoint LPM	LPM	Real
15							
16							
17							
18		InputPage0	PTIMESP	%DB31.DBD148	Pressure Flow Setpoint Time	SEC	Real
19							
20							
21							
22		InputPage0	EFLOWSP	%DB31.DBD152	Exhaust Flow Setpoint LPM	LPM	Real
23							
24							
25							
26		InputPage0	ETIMESP	%DB31.DBD156	Exhaust Flow Setpoint Time	SEC	Real
27							
28							
29							
30		InputPage0	PRV1	%DB31.DBD160	Flow Regulator Setpoint	BAR/PSI	Real
31							
32							
33							
34		InputPage0	PRV2	%DB31.DBD164	Exhaust Regulator Setpoint	BAR/PSI	Real
35							
36							
37							
38		InputPage0	PV1	%DB31.DBD168	Flow Proportional Valve Setpoint	%	Real
39							
40							
41							
42		InputPage0	PV2	%DB31.DBD172	Exhaust Proportional Valve Setpoint	%	Real
43							
44							
45							
46		InputPage0	BatchName[0]	%DB31.DBB176	Batch Name		ASCII
47			BatchName[1]	%DB31.DBB177			ASCII
48			BatchName[2]	%DB31.DBB178			ASCII
49			BatchName[3]	%DB31.DBB179			ASCII
50			BatchName[4]	%DB31.DBB180			ASCII
51..63			Unused				

Table 22. Input Page 1

Profibus Address		Tagname plc in DB31		PLC Address	Definition	Units	Data type
Byte #	Bit #	Structure	Tagname in structure				
0	0	InputPageX	PB_ATF_START_STOP	%DB31.DBX128.0	AFT 1=Start/0=Stop		Byte
	1	InputPageX	PB_ATF_Ack_Alarms	%DB31.DBX128.1	Acknowledge Alarms		
	2	InputPageX	PB_Reset_Counters	%DB31.DBX128.2	Reset Algorithm Counters		
	3	InputPageX	PB_ATF_Control_Mode	%DB31.DBX128.3	Control Mode		
	4	InputPageX	PB_ATF_Slope_Enabled	%DB31.DBX128.4	Enable Slope Function		
	5						
	6						
	7						
1		InputPageX	RequestedDataPage	%DB31.DBW130	Requested Data Page		Int-16
2							
3		InputPageX	SendingDataPage	%DB31.DBW132	Sending Data Page		Int-16
4							
5		InputPage1	Model_Num_HMI	%DB31.DBW194	XCell ATF® Model Number 0=ATF 4, 1= ATF 4 MC, 2=ATF6, 3=ATF 10 Legacy, 4=ATF10		Int-16
6							
7		InputPage1	WATSP	%DB31.DBW196	Warning / Alarm Timer SP	MIN	Int-16
8							
9		InputPage1	Bioreactor_Backpressure	%DB31.DBD198	Bioreactor Pressure	BAR/PSI	Real
10							
11							
12							
13		InputPage1	Height_Differential	%DB31.DBW202	Height Differential	CM	Int-16
14							
15		InputPage1	FDFOFST	%DB31.DBD204	Flow Driving Force Offset for Switching	BAR/PSI	Real
16							
17							
18							
19		InputPage1	Press_Cycle_Delay_Time_SP	%DB31.DBW208	Pressure Cycle Delay Time SP	%	Int-16
20							
21		InputPage1	Press_Cycle_Over_Time_SP	%DB31.DBW210	Pressure Cycle Over Time SP	%	Int-16
22							
23		InputPage1	Pres_Cycl_PV_Step_Size	%DB31.DBD212	Pressure Cycle - PV Step Size - %	%	Real
24							
25							
26							
27		InputPage1	EDFOFST	%DB31.DBD216	Exhaust Driving Force Offset for switching	BAR/PSI	Real
28							
29							
30							
31		InputPage1	Vac_Cycle_Delay_Time_SP	%DB31.DBW220	Vaccum Cycle Delay Time SP	%	Int-16
32							
33		InputPage1	Vac_Cycle_Over_Time_SP	%DB31.DBW222	Vaccum Cycle Over Time SP	%	Int-16
34							
35		InputPage1	Exhs_Cycl_PV_Step_Size	%DB31.DBD224	Exhaust Cycle – PV Step Size	%	Real
36							
37							
38							
39		InputPage1	P2_Pressure_Alarm_Hi_Hi_SP	%DB31.DBD228	P2 - Alarm SP – High	BAR/PSI	Real
40							
41							
42							
43		InputPage1	P2_Alarm_Hi_Hi_TMR_SP	%DB31.DBW232	P2 - Alarm Delay SP - High	10MSEC	Int-16
44							

Profibus Address		Tagname plc in DB31		PLC Address	Definition	Units	Data type
Byte #	Bit #	Structure	Tagname in structure				
45 46 47 48		InputPage1	P2_Pressure_Alarm_Lo_Lo_SP	%DB31.DBD234	P2 - Alarm SP – Low	BAR/PSI	Real
49 50		InputPage1	P2_Alarm_Lo_Lo_TMR_SP	%DB31.DBW238	P2 - Alarm Delay SP - Low	10MSEC	Int-16
51 52 53 54		InputPage1	PFLOWMAXSP	%DB31.DBD240	Max Pressure Flow Setpoint	LPM	Real
55 56 57 58		InputPage1	PFLOWMINSP	%DB31.DBD244	Min Pressure Flow Setpoint	LPM	Real
59 60 61 62		InputPage1	EFLOWMAXSP	%DB31.DBD248	Max Exhaust Flow Setpoint	LPM	Real
63			Unused				

Table 23. Input Page 2

Profibus Address		Tagname plc in DB31		PLC Address	Definition	Units	Data type
Byte #	Bit #	Structure	Tagname in structure				
0	0	InputPageX	PB_ATF_START_STOP	%DB31.DBX128.0	AFT 1=Start/0=Stop		Byte
	1	InputPageX	PB_ATF_Ack_Alarms	%DB31.DBX128.1	Acknowledge Alarms		
	2	InputPageX	PB_Reset_Counters	%DB31.DBX128.2	Reset Algorithm Counters		
	3	InputPageX	PB_ATF_Control_Mode	%DB31.DBX128.3	Control Mode		
	4	InputPageX	PB_ATF_Slope_Enabled	%DB31.DBX128.4	Enable Slope Function		
	5						
	6						
	7						
1	0	InputPageX	RequestedDataPage	%DB31.DBW130	Requested Data Page		Int-16
2	0						
3	0	InputPageX	SendingDataPage	%DB31.DBW132	Sending Data Page		Int-16
4	0						
5		InputPage2	EFLOWMINSP	%DB31.DBD252	Min Exhaust Flow Setpoint	LPM	Real
6							
7							
8							
9		InputPage2	PTIMEMAXSP	%DB31.DBD256	Max Pressure Flow Setpoint	SEC	Real
10							
11							
12							
13		InputPage2	PTIMEMINSP	%DB31.DBD260	Min Pressure Flow Setpoint	SEC	Real
14							
15							
16							
17		InputPage2	ETIMEMAXSP	%DB31.DBD264	Max Exhaust Flow Setpoint	SEC	Real
18							
19							
20							
21		InputPage2	ETIMEMINSP	%DB31.DBD268	Min Exhaust Flow Setpoint	SEC	Real
22							
23							
24							
25		InputPage2	PV1MAX	%DB31.DBD272	Flow Proportional Valve Max Value	%	Real
26							
27							
28							
29		InputPage2	PV1MIN	%DB31.DBD276	Flow Proportional Valve Min Value	%	Real
30							
31							
32							
33		InputPage2	PV2MAX	%DB31.DBD280	Exhaust Proportional Valve Max Value	%	Real
34							
35							
36							
37		InputPage2	PV2MIN	%DB31.DBD284	Exhaust Proportional Valve Min Value	%	Real
38							
39							
40							
41		InputPage2	PRV1MAX	%DB31.DBD288	Pressure Regulator Maximum Value	BAR/PSI	Real
42							
43							
44							
45		InputPage2	PRV1MIN	%DB31.DBD292	Pressure Regulator Minimum Value	BAR/PSI	Real
46							
47							
48							
49		InputPage2	PRV2MAX	%DB31.DBD296	Exhaust Regulator Maximum Value	BAR/PSI	Real
50							
51							
52							
53		InputPage2	PRV2MIN	%DB31.DBD300	Exhaust Regulator Minimum Value	BAR/PSI	Real
54							
55							
56							
57..63			Unused				

Table 24. Input Page 3

Profibus Address		Tagname plc in DB31		PLC Address	Definition	Units	Data type
Byte #	Bit #	Structure	Tagname in structure				
0	0	InputPageX	P2_Cal_Enable	%DB31.DBX376.0	P2 Cal Select Button		Byte
	1	InputPageX	PRV1_Cal_Enable	%DB31.DBX376.1	PRV1 Cal Select Button		
	2	InputPageX	PRV2_Cal_Enable	%DB31.DBX376.2	PRV2 Cal Select Button		
	3	InputPageX	P3_Cal_Enable	%DB31.DBX376.3	P3 Cal Select Button		
	4	InputPageX	P4_Cal_Enable	%DB31.DBX376.4	P4 Cal Select Button		
	5	InputPageX	P5_Cal_Enable	%DB31.DBX376.5	P5 Cal Select Button		
	6	InputPageX	W1_Cal_Enable	%DB31.DBX376.6	W1 Cal Select Button		
	7						
1		InputPageX	RequestedDataPage	%DB31.DBW378	Requested Data Page		Int-16
2							
3		InputPageX	SendingDataPage	%DB31.DBW380	Sending Data Page		Int-16
4							
5		InputPage3	PV1_SP	%DB31.DBD382	PV1 Setpoint Value	%	Real
6							
7							
8							
9		InputPage3	PV2_SP	%DB31.DBD386	PV2 Setpoint Value	%	Real
10							
11							
12							
13		InputPage3	PRV1_SP	%DB31.DBD390	PRV1 Setpoint Value	PSI/Bar	Real
14							
15							
16							
17		InputPage3	PRV2_SP	%DB31.DBD394	PRV2 Setpoint Value	PSI/Bar	Real
18							
19							
20							
21		InputPage3	P2_P1_EU	%DB31.DBD398	P2 First Point Cal Engineering Units	PSI/Bar	Real
22							
23							
24							
25		InputPage3	P2_P2_EU	%DB31.DBD402	P2 Second Point Cal Engineering Units	PSI/Bar	Real
26							
27							
28							
29		InputPage3	PRV1_P1_EU	%DB31.DBD406	PRV1 First Point Cal Engineering Units	PSI/Bar	Real
30							
31							
32							
33		InputPage3	PRV1_P2_EU	%DB31.DBD410	PRV1 Second Point Cal Engineering Units	PSI/Bar	Real
34							
35							
36							
37		InputPage3	PRV2_P1_EU	%DB31.DBD414	PRV2 First Point Cal Engineering Units	PSI/Bar	Real
38							
39							
40							
41		InputPage3	PRV2_P2_EU	%DB31.DBD418	PRV2 Second Point Cal Engineering Units	PSI/Bar	Real
42							
43							
44							
45		InputPage3	P3_P1_EU	%DB31.DBD422	P3 First Point Cal Engineering Units	PSI/Bar	Real
46							
47							
48							
49		InputPage3	P3_P2_EU	%DB31.DBD426	P3 Second Point Cal Engineering Units	PSI/Bar	Real
50							
51							
52							

Profibus Address		Tagname plc in DB31		PLC Address	Definition	Units	Data type
Byte #	Bit #	Structure	Tagname in structure				
53	0	InputPage3	P2_P1_Capture	%DB31.DBD430.0			
	1		P2_P2_Capture	%DB31.DBD430.1			
	2		P2_Accept	%DB31.DBD430.2			
	3		PRV1_P1_Capture	%DB31.DBD430.3			
	4		PRV1_P2_Capture	%DB31.DBD430.4			
	5		PRV1_Accept	%DB31.DBD430.5			
	6		PRV2_P1_Capture	%DB31.DBD430.6			
	7		PRV2_P2_Capture	%DB31.DBD430.7			
54	0	InputPage3	PRV2_Accept	%DB31.DBD431.0			
	1		P3_P1_Capture	%DB31.DBD431.1			
	2		P3_P2_Capture	%DB31.DBD431.2			
	3		P3_Accept	%DB31.DBD431.3			
	4		Force_Solenoid	%DB31.DBD431.4			
	5						
	6						
	7						
55..63			Unused				

Table 25. Input Page 4

Profibus Address		Tagname plc in DB31		PLC Address	Definition	Units	Data type
Byte #	Bit #	Structure	Tagname in structure				
0	0	InputPageX	P2_Cal_Enable	%DB31.DBX432.0	P2 Cal Select Button		Byte
	1	InputPageX	PRV1_Cal_Enable	%DB31.DBX432.1	PRV1 Cal Select Button		
	2	InputPageX	PRV2_Cal_Enable	%DB31.DBX432.2	PRV2 Cal Select Button		
	3	InputPageX	P3_Cal_Enable	%DB31.DBX432.3	P3 Cal Select Button		
	4	InputPageX	P4_Cal_Enable	%DB31.DBX432.4	P4 Cal Select Button		
	5	InputPageX	P5_Cal_Enable	%DB31.DBX432.5	P5 Cal Select Button		
	6	InputPageX	W1_Cal_Enable	%DB31.DBX432.6	W1 Cal Select Button		
	7						
1		InputPageX	RequestedDataPage	%DB31.DBW434	Requested Data Page		Int-16
2							
3		InputPageX	SendingDataPage	%DB31.DBW436	Sending Data Page		Int-16
4							
5		InputPage4	PV1_SP	%DB31.DBD438	PV1 Setpoint Value	%	Real
6							
7							
8							
9		InputPage4	PV2_SP	%DB31.DBD442	PV2 Setpoint Value	%	Real
10							
11							
12							
13		InputPage4	PRV1_SP	%DB31.DBD446	PRV1 Setpoint Value	PSI/Bar	Real
14							
15							
16							
17		InputPage4	PRV2_SP	%DB31.DBD450	PRV2 Setpoint Value	PSI/Bar	Real
18							
19							
20							
21		InputPage4	P4_P1_EU	%DB31.DBD454	P4 First Point Cal Engineering Units	PSI/Bar	Real
22							
23							
24							
25		InputPage4	P4_P2_EU	%DB31.DBD458	P4 Second Point Cal Engineering Units	PSI/Bar	Real
26							
27							
28							
29		InputPage4	P5_P1_EU	%DB31.DBD462	P5 First Point Cal Engineering Units	PSI/Bar	Real
30							
31							
32							
33		InputPage4	P5_P2_E	%DB31.DBD466	P5 Second Point Cal Engineering Units	PSI/Bar	Real
34							
35							
36							
37		InputPage4	W1_P1_EU	%DB31.DBD470	W1 First Point Cal Engineering Units	PSI/Bar	Real
38							
39							
40							
41		InputPage4	W1_P2_EU	%DB31.DBD474	W1 Second Point Cal Engineering Units	KG	Real
42							
43							
44							
45		0	InputPage4	P4_P1_Capture	%DB31.DBD478.0		Byte
		1	InputPage4	P4_P2_Capture	%DB31.DBD478.1		
		2	InputPage4	P4_Accept	%DB31.DBD478.2		
		3	InputPage4	P5_P1_Capture	%DB31.DBD478.3		
		4	InputPage4	P5_P2_Capture	%DB31.DBD478.4		
		5	InputPage4	P5_Accept	%DB31.DBD478.5		
		6	InputPage4	W1_P1_Capture	%DB31.DBD478.6		
		7	InputPage4	W1_P2_Capture	%DB31.DBD478.7		

Profibus Address		Tagname plc in DB31		PLC Address	Definition	Units	Data type
Byte #	Bit #	Structure	Tagname in structure				
46	0	InputPage4	W1_Accept	%DB31.DBD479.0			Byte
	1	InputPage4	Force_Solenoid	%DB31.DBD479.1			
	2			%DB31.DBD479.2			
	3			%DB31.DBD479.3			
	4			%DB31.DBD479.4			
	5			%DB31.DBD479.5			
	6			%DB31.DBD479.6			
	7			%DB31.DBD479.7			
47							
48							
49							
50							
51							
52							
53							
54							
55..63			Unused				

14.15 Profibus output signals (from XCell ATF® Device to Master)

The following parameters can be read by the Profibus Master. The XCell™ C410:V4B Controller sends parameters with the system in remote or local control mode. The heartbeat signal toggles every 1000 ms.

Table 26. Output Page 0

Profibus Address		Tagname plc in DB31		PLC Address	Definition	Units	Data type
Byte #	Bit #	Structure	Tagname in structure				
0		OutputPageX	ActiveDataPage	%DB31.DBW310	Active Data Page		Int-16
1							
2	0	OutputPageX	ATF_HeartBeat	%DB31.DBX312.0	XCell ATF® Heartbeat		Byte
	1	OutputPageX	Rem_Profibus	%DB31.DBX312.1	XCell ATF® Remote Mode (Profibus)		
	2	OutputPageX	ATF_Trouble	%DB31.DBX312.2	XCell ATF® Common Trouble Alarm		
	3	OutputPageX	ATF_Running	%DB31.DBX312.3	XCell ATF® Run Status		
	4	OutputPageX	Pump_Alarm_0	%DB31.DBX312.4	Pump Alarm		
	5	OutputPageX	Pump_Alarm_1	%DB31.DBX312.5	Power Loss While Pump Running Alarm		
	6	OutputPageX	Pump_Alarm_2	%DB31.DBX312.6	P2 High Pressure Alarm		
	7						
3		OutputPage0	PFLOW	%DB31.DBD314	XCell ATF® Pressure Cycle Flow	LPM	Real
4							
5							
6							
7		OutputPage0	PTIME	%DB31.DBD318	XCell ATF® Pressure Cycle Time	SEC	Real
8							
9							
10							
11		OutputPage0	EFLOW	%DB31.DBD322	XCell ATF® Exhaust Cycle Flow	LPM	Real
12							
13							
14							
15		OutputPage0	ETIME	%DB31.DBD326	XCell ATF® Exhaust Cycle Time	SEC	Real
16							
17							
18							
19		OutputPage0	PV1	%DB31.DBD330	XCell ATF® Pressure Proportional Valve (PV1) Position	%	Real
20							
21							
22							
23		OutputPage0	PV2	%DB31.DBD334	XCell ATF® Exhaust Proportional Valve (PV2) Position	%	Real
24							
25							
26							
27		OutputPage0	PRV1_PV	%DB31.DBD338	XCell ATF® Pressure at PRV1	BAR/PSI	Real
28							
29							
30							
31		OutputPage0	PRV2_PV	%DB31.DBD342	XCell ATF® Pressure at PRV2	BAR/PSI	Real
32							
33							
34							
35		OutputPage0	P2_PV	%DB31.DBD346	XCell ATF® Pressure at P2	BAR/PSI	Real
36							
37							
38							
39		OutputPage0	APC_PFlowPrimary	%DB31.DBW350	Algorithm Performance Counter - P-Flow - Primary		Int-16
40							

Profibus Address		Tagname plc in DB31		PLC Address	Definition	Units	Data type
Byte #	Bit #	Structure	Tagname in structure				
41 42		OutputPage0	APC_PFlowOverride	%DB31.DBW352	Algorithm Performance Counter - P-Flow - Override		Int-16
43 44		OutputPage0	APC_PFlowOvertime	%DB31.DBW354	Algorithm Performance Counter - P-Flow - Overtime		Int-16
45 46		OutputPage0	APC_VFlowPrimary	%DB31.DBW356	Algorithm Performance Counter - V-Flow - Primary		Int-16
47 48		OutputPage0	APC_VFlowOverride	%DB31.DBW358	Algorithm Performance Counter - V-Flow - Override		Int-16
49 50		OutputPage0	APC_VFlowOvertime	%DB31.DBW360	Algorithm Performance Counter - V-Flow - Overtime		Int-16
51 52 53 54		OutputPage0	P3_PV	%DB31.DBD362	XCell ATF® Pressure at P3	BAR/PSI	Real
55	0	OutputPage0	Warning_0	%DB31.DBX366.0	PV1>=PV1Max		Byte
	1	OutputPage0	Warning_1	%DB31.DBX366.1	PV1<=PV1Min		
	2	OutputPage0	Warning_2	%DB31.DBX366.2	PV2>=PV2Max		
	3	OutputPage0	Warning_3	%DB31.DBX366.3	PV2<=PV2Min		
	4	OutputPage0	Warning_4	%DB31.DBX366.4	P2<=P2 Low Setpoint		
	5	OutputPage0	System Stop Active	%DB31.DBX366.5	Set when SS pressed, reset when XCell ATF® start or first scan		
	6	OutputPage0		%DB31.DBX366.6			
	7	OutputPage0		%DB31.DBX366.7			
56	0	OutputPage0	PB_ATF_START_STOP	%DB31.DBX367.0	AFT Start/Stop		Byte
	1	OutputPage0	PB_ATF_Ack_Alarms	%DB31.DBX367.1	XCell ATF® Acknowledge Alarms		
	2						
	3						
	4						
	5						
	6						
57 58		OutputPage0	ATF_Connected_Bioreactor	%DB31.DBW368	XCell ATF® Connected Bioreactor		Int-16
59 60 61 62 63		OutputPage0	BatchName[0] BatchName[1] BatchName[2] BatchName[3] BatchName[4]	%DB31.DBB370 %DB31.DBB371 %DB31.DBB372 %DB31.DBB373 %DB31.DBB374	Batch Name		ASCII ASCII ASCII ASCII ASCII

Table 27. Output Page 1

Profibus Address		Tagname plc in DB31		PLC Address	Definition	Units	Data type
Byte #	Bit #	Structure	Tagname in structure				
0		OutputPageX	ActiveDataPage	%DB31.DBW310	Active Data Page		Int-16
1							
2	0	OutputPageX	ATF_HeartBeat	%DB31.DBX312.0	XCell ATF® Heartbeat		Byte
	1	OutputPageX	Rem_Profibus	%DB31.DBX312.1	XCell ATF® Remote Mode (Profibus)		
	2	OutputPageX	ATF_Trouble	%DB31.DBX312.2	XCell ATF® Common Trouble Alarm		
	3	OutputPageX	ATF_Running	%DB31.DBX312.3	XCell ATF® Run Status		
	4	OutputPageX	Pump_Alarm_0	%DB31.DBX312.4	Pump Alarm		
	5	OutputPageX	Pump_Alarm_1	%DB31.DBX312.5	Power Loss While Pump Running Alarm		
	6	OutputPageX	Pump_Alarm_2	%DB31.DBX312.6	P2 High Pressure Alarm		
	7						
3		OutputPage1	P2_PV	%DB31.DBD480	XCell ATF® Pressure at P2	PSI/Bar	Real
4							
5							
6							
7		OutputPage1	PRV1_PV	%DB31.DBD484	XCell ATF® Pressure at PRV1	PSI/Bar	Real
8							
9							
10							
11		OutputPage1	PRV2_PV	%DB31.DBD488	XCell ATF® Pressure at PRV2	PSI/Bar	Real
12							
13							
14							
15		OutputPage1	P3_PV	%DB31.DBD492	XCell ATF® Pressure at P3	PSI/Bar	Real
16							
17							
18							
19		OutputPage1	P4_PV	%DB31.DBD496	XCell ATF® Pressure at P4	PSI/Bar	Real
20							
21							
22							
23		OutputPage1	P5_PV	%DB31.DBD500	XCell ATF® Pressure at P5	PSI/Bar	Real
24							
25							
26							
27		OutputPage1	W1_PV	%DB31.DBD504	Force at Loadcell W1	KG	Real
28							
29							
30							
31	0	OutputPage1	SOL_1	%DB31.DBD508.0	Turn On Solenoid 1		Byte
	1		Bar_Mode	%DB31.DBD508.1			
	2		PSI_Mode	%DB31.DBD508.2			
	3		AIW04_Cal_Enable	%DB31.DBD508.3			
	4		AIW04_Cal_Accept_Vis	%DB31.DBD508.4			
	5		AIW06_Cal_Enable	%DB31.DBD508.5			
	6		AIW06_Cal_Accept_Vis	%DB31.DBD508.6			
	7		AIW08_Cal_Enable	%DB31.DBD508.7			
32	0	OutputPage1	AIW08_Cal_Accept_Vis	%DB31.DBD509.0			
	1		AIW12_Cal_Enable	%DB31.DBD509.1			
	2		AIW12_Cal_Accept_Vis	%DB31.DBD509.2			
	3		AIW14_Cal_Enable	%DB31.DBD509.3			
	4		AIW14_Cal_Accept_Vis	%DB31.DBD509.4			
	5		AIW16_Cal_Enable	%DB31.DBD509.5			
	6		AIW16_Cal_Accept_Vis	%DB31.DBD509.6			
	7		AIW18_Cal_Enable	%DB31.DBD509.7			

Profibus Address		Tagname plc in DB31		PLC Address	Definition	Units	Data type
Byte #	Bit #	Structure	Tagname in structure				
33	0	OutputPage1	AIW18_Cal_Accept_Vis	%DB31.DBD510.0			
	1			%DB31.DBD510.1			
	2			%DB31.DBD510.2			
	3			%DB31.DBD510.3			
	4			%DB31.DBD510.4			
	5			%DB31.DBD510.5			
	6			%DB31.DBD510.6			
	7			%DB31.DBD510.7			
34							
35		OutputPage1	PFLOWSP	%DB31.DBD512	Pressure Flow Setpoint LPM	LPM	Real
36							
37							
38							
39		OutputPage1	PTIMESP	%DB31.DBD516	Pressure Flow Setpoint Time	SEC	Real
40							
41							
42							
43		OutputPage1	EFLOWSP	%DB31.DBD520	Exhaust Flow Setpoint LPM	LPM	Real
44							
45							
46							
47		OutputPage1	ETIMESP	%DB31.DBD524	Exhaust Flow Setpoint Time	SEC	Real
48							
49							
50							
51		OutputPage1	PRV1	%DB31.DBD528	Flow Regulator Setpoint	BAR/PS I	Real
52							
53							
54							
55		OutputPage1	PRV2	%DB31.DBD532	Exhaust Regulator Setpoint	BAR/PS	Real
56							
57							
58							
59		OutputPage1	PV1	%DB31.DBD536	Flow Proportional Valve Setpoint	%	Real
60							
61							
62							
63							

Table 28. Output Page 2

Profibus Address		Tagname plc in DB31		PLC Address	Definition	Units	Data type
Byte #	Bit #	Structure	Tagname in structure				
0		OutputPageX	ActiveDataPage	%DB31.DBW310	Active Data Page		Int-16
1							
2	0	OutputPageX	ATF_HeartBeat	%DB31.DBX312.0	XCell ATF® Heartbeat		Byte
	1	OutputPageX	Rem_Profibus	%DB31.DBX312.1	XCell ATF® Remote Mode (Profibus)		
	2	OutputPageX	ATF_Trouble	%DB31.DBX312.2	XCell ATF® Common Trouble Alarm		
	3	OutputPageX	ATF_Running	%DB31.DBX312.3	XCell ATF® Run Status		
	4	OutputPageX	Pump_Alarm_0	%DB31.DBX312.4	Pump Alarm		
	5	OutputPageX	Pump_Alarm_1	%DB31.DBX312.5	Power Loss While Pump Running Alarm		
	6	OutputPageX	Pump_Alarm_2	%DB31.DBX312.6	P2 High Pressure Alarm		
	7						
3		OutputPage2	PV2	%DB31.DBD542	Exhaust Proportional Valve Setpoint	%	Real
4							
5							
6							
7		OutputPage2	Model_Num_HMI	%DB31.DBW546	XCell ATF® Model Number 0=XCell ATF® 4, 1=XCell ATF® 4MC, 2=XCell ATF® 6, 3=XCell ATF® 10 Legacy 4=XCell ATF® 10		Int-16
8							
9		OutputPage2	WATSP	%DB31.DBW548	Warning/Alarm Timer SP	MIN	Int-16
10							
11		OutputPage2	Bioreactor_Backpressure	%DB31.DBD550	Bioreactor Pressure	BAR/PSI	Real
12							
13							
14							
15		OutputPage2	Height_Differential	%DB31.DBW554	Height Differential	CM	Int-16
16							
17		OutputPage2	FDFOFST	%DB31.DBD556	Flow Driving Force Offset for Switching	BAR/PSI	Real
18							
19							
20							
21		OutputPage2	Press_Cycle_Delay_Time_SP	%DB31.DBW560	Pressure Cycle Delay Time SP	%	Int-16
22							
23		OutputPage2	Press_Cycle_Over_Time_SP	%DB31.DBW562	Pressure Cycle Over Time SP	%	Int-16
24							
25		OutputPage2	Pres_Cycl_PV_Step_Size	%DB31.DBD564	Pressure Cycle - PV Step Size - %	%	Real
26							
27							
28							
29		OutputPage2	EDFOFST	%DB31.DBD568	Exhaust Driving Force Offset for switching	BAR/PSI	Real
30							
31							
32							
33		OutputPage2	Vac_Cycle_Delay_Time_SP	%DB31.DBW572	Vaccum Cycle Delay Time SP	%	Int-16
34							
35		OutputPage2	Vac_Cycle_Over_Time_SP	%DB31.DBW574	Vaccum Cycle Over Time SP	%	Int-16
36							
37		OutputPage2	Exhs_Cycl_PV_Step_Size	%DB31.DBD576	Exhaust Cycle - PV Step Size	%	Real
38							
39							
40							

Profibus Address Byte #	Tagname plc in DB31		PLC Address	Definition	Units	Data type
	Bit #	Structure				
41 42 43 44		OutputPage2	P2_Pressure_Alarm_Hi_Hi_SP	%DB31.DBD580	P2 - Alarm SP - High	BAR/PSI Real
45 46		OutputPage2	P2_Alarm_Hi_Hi_TMR_SP	%DB31.DBW584	P2 - Alarm Delay SP - High	10MSEC Int-16
47 48 49 50		OutputPage2	P2_Pressure_Alarm_Lo_Lo_SP	%DB31.DBD586	P2 - Alarm SP - Low	BAR/PSI Real
51 52		OutputPage2	P2_Alarm_Lo_Lo_TMR_SP	%DB31.DBW590	P2 - Alarm Delay SP - Low	10MSEC Int-16
53 54 55 56		OutputPage2	PFLOWMAXSP	%DB31.DBD592	Max Pressure Flow Setpoint	LPM Real
57 58 59 60		OutputPage2	PFLOWMINSP	%DB31.DBD596	Min Pressure Flow Setpoint	LPM Real
61 62 63		OutputPage2	LastSentInputPage	%DB31.DBW600	Last Sending Data Page Number	Int-16
				%DB31.DBX602		

Table 29. Output Page 3

Profibus Address		Tagname plc in DB31		PLC Address	Definition	Units	Data type
Byte #	Bit #	Structure	Tagname in structure				
0		OutputPageX	ActiveDataPage	%DB31.DBW310	Active Data Page		Int-16
1							
2	0	OutputPageX	ATF_HeartBeat	%DB31.DBX312.0	XCell ATF® Heartbeat		Byte
	1	OutputPageX	Rem_Profibus	%DB31.DBX312.1	XCell ATF® Remote Mode (Profibus)		
	2	OutputPageX	ATF_Trouble	%DB31.DBX312.2	XCell ATF® Common Trouble Alarm		
	3	OutputPageX	ATF_Running	%DB31.DBX312.3	XCell ATF® Run Status		
	4	OutputPageX	Pump_Alarm_0	%DB31.DBX312.4	Pump Alarm		
	5	OutputPageX	Pump_Alarm_1	%DB31.DBX312.5	Power Loss While Pump Running Alarm		
	6	OutputPageX	Pump_Alarm_2	%DB31.DBX312.6	P2 High Pressure Alarm		
	0						
3		OutputPage3	EFLOWMAXSP	%DB31.DBD604	Max Exhaust Flow Setpoint	LPM	Real
4							
5							
6							
7		OutputPage3	EFLOWMINSP	%DB31.DBD608	Min Exhaust Flow Setpoint	LPM	Real
8							
9							
10							
11		OutputPage3	PTIMEMAXSP	%DB31.DBD612	Max Pressure Flow Setpoint	SEC	Real
12							
13							
14							
15		OutputPage3	PTIMEMINSP	%DB31.DBD616	Min Pressure Flow Setpoint	SEC	Real
16							
17							
18							
19		OutputPage3	ETIMEMAXSP	%DB31.DBD620	Max Exhaust Flow Setpoint	SEC	Real
20							
21							
22							
23		OutputPage3	ETIMEMINSP	%DB31.DBD624	Min Exhaust Flow Setpoint	SEC	Real
24							
25							
26							
27		OutputPage3	PV1MAX	%DB31.DBD628	Flow Proportional Valve Max Value	%	Real
28							
29							
30							
31		OutputPage3	PV1MIN	%DB31.DBD632	Flow Proportional Valve Min Value	%	Real
32							
33							
34							
35		OutputPage3	PV2MAX	%DB31.DBD636	Exhaust Proportional Valve Max Value	%	Real
36							
37							
38							
39		OutputPage3	PV2MIN	%DB31.DBD640	Exhaust Proportional Valve Min Value	%	Real
40							
41							
42							
43		OutputPage3	PRV1MAX	%DB31.DBD644	Pressure Regulator Maximum Value	BAR/PSI	Real
44							
45							
46							

Profibus Address		Tagname plc in DB31		PLC Address	Definition	Units	Data type
Byte #	Bit #	Structure	Tagname in structure				
47		OutputPage3	PRV1MIN	%DB31.DBD648	Pressure Regulator Minimum Value	BAR/PSI	Real
48							
49							
50							
51		OutputPage3	PRV2MAX	%DB31.DBD652	Exhaust Regulator Maximum Value	BAR/PSI	Real
52							
53							
54							
55		OutputPage3	PRV2MIN	%DB31.DBD656	Exhaust Regulator Minimum Value	BAR/PSI	Real
56							
57							
58							
59		OutputPage3	ATF_Number	%DB31.DBD660	Identification number of ATF System		Dint
60							
61							
62							
63				%DB31.DBX664			

Table 30. Output Page 4

Profibus Address		Tagname plc in DB31		PLC Address	Definition	Units	Data type
Byte #	Bit #	Structure	Tagname in structure				
0		OutputPageX	ActiveDataPage	%DB31.DBW310	Active Data Page		Int-16
1							
2	0	OutputPageX	ATF_HeartBeat	%DB31.DBX312.0	XCell ATF® Heartbeat		Byte
	1	OutputPageX	Rem_Profibus	%DB31.DBX312.1	XCell ATF® Remote Mode (Profibus)		
	2	OutputPageX	ATF_Trouble	%DB31.DBX312.2	XCell ATF® Common Trouble Alarm		
	3	OutputPageX	ATF_Running	%DB31.DBX312.3	XCell ATF® Run Status		
	4	OutputPageX	Pump_Alarm_0	%DB31.DBX312.4	Pump Alarm		
	5	OutputPageX	Pump_Alarm_1	%DB31.DBX312.5	Power Loss While Pump Running Alarm		
	6	OutputPageX	Pump_Alarm_2	%DB31.DBX312.6	P2 High Pressure Alarm		
	7						
3	0	OutputPage4	P2_Cal_Enable	%DB31.DBX666.0	P2 Cal Select Button		Byte
	1	OutputPage4	PRV1_Cal_Enable	%DB31.DBX666.1	PRV1 Cal Select Button		
	2	OutputPage4	PRV2_Cal_Enable	%DB31.DBX666.2	PRV2 Cal Select Button		
	3	OutputPage4	P3_Cal_Enable	%DB31.DBX666.3	P3 Cal Select Button		
	4	OutputPage4	P4_Cal_Enable	%DB31.DBX666.4	P4 Cal Select Button		
	5	OutputPage4	P5_Cal_Enable	%DB31.DBX666.5	P5 Cal Select Button		
	6	OutputPage4	W1_Cal_Enable	%DB31.DBX666.6	W1 Cal Select Button		
	7			%DB31.DBX666.7			
4							
5		OutputPage4	P2_P1_EU	%DB31.DBD668	P2 First Point Cal Engineering Units	PSI/Bar	Real
6							
7							
8							
9		OutputPage4	P2_P2_EU	%DB31.DBD672	P2 Second Point Cal Engineering Units	PSI/Bar	Real
10							
11							
12							
13		OutputPage4	PRV1_P1_EU	%DB31.DBD676	PRV1 First Point Cal Engineering Units	PSI/Bar	Real
14							
15							
16							
17		OutputPage4	PRV1_P2_EU	%DB31.DBD680	PRV1 Second Point Cal Engineering Units	PSI/Bar	Real
18							
19							
20							
21		OutputPage4	PRV2_P1_EU	%DB31.DBD684	PRV2 First Point Cal Engineering Units	PSI/Bar	Real
22							
23							
24							
25		OutputPage4	PRV2_P2_EU	%DB31.DBD688	PRV2 Second Point Cal Engineering Units	PSI/Bar	Real
26							
27							
28							
29		OutputPage4	P3_P1_EU	%DB31.DBD692	P3 First Point Cal Engineering Units	PSI/Bar	Real
30							
31							
32							

Profibus Address		Tagname plc in DB31		PLC Address	Definition	Units	Data type
Byte #	Bit #	Structure	Tagname in structure				
33 34 35 36		OutputPage4	P3_P2_EU	%DB31.DBD696	P3 Second Point Cal Engineering Units	PSI/Bar	Real
37 38 39 40		OutputPage4	P4_P1_EU	%DB31.DBD700	P4 First Point Cal Engineering Units	PSI/Bar	Real
41 42 43 44		OutputPage4	P4_P2_EU	%DB31.DBD704	P4 Second Point Cal Engineering Units	PSI/Bar	Real
45 46 47 48		OutputPage4	P5_P1_EU	%DB31.DBD708	P5 First Point Cal Engineering Units	PSI/Bar	Real
49 50 51 52		OutputPage4	P5_P2_E	%DB31.DBD712	P5 Second Point Cal Engineering Units	PSI/Bar	Real
53 54 55 56		OutputPage4	W1_P1_EU	%DB31.DBD716	W1 First Point Cal Engineering Units	PSI/Bar	Real
57 58 59 60		OutputPage4	W1_P2_EU	%DB31.DBD720	W1 Second Point Cal Engineering Units	KG	Real
61	0	OutputPage4	P2_P1_Capture	%DB31.DBX724.0			
	1		P2_P2_Capture	%DB31.DBX724.1			
	2		P2_Accept	%DB31.DBX724.2			
	3		PRV1_P1_Capture	%DB31.DBX724.3			
	4		PRV1_P2_Capture	%DB31.DBX724.4			
	5		PRV1_Accept	%DB31.DBX724.5			
	6		PRV2_P1_Capture	%DB31.DBX724.6			
	7		PRV2_P2_Capture	%DB31.DBX724.7			
62	0	OutputPage4	OutputPage4	%DB31.DBX725.0			
	1		PRV2_Accept	%DB31.DBX725.1			
	2		P3_P1_Capture	%DB31.DBX725.2			
	3		P3_P2_Capture	%DB31.DBX725.3			
	4		P3_Accept	%DB31.DBX725.4			
	5		P4_P1_Capture	%DB31.DBX725.5			
	6		P4_P2_Capture	%DB31.DBX725.6			
	7		P4_Accept	%DB31.DBX725.7			
63	0	OutputPage4	P5_P2_Capture	%DB31.DBX726.0			
	1		P5_Accept	%DB31.DBX726.1			
	2		W1_P1_Capture	%DB31.DBX726.2			
	3		W1_P2_Capture	%DB31.DBX726.3			
	4		W1_Accept	%DB31.DBX726.4			
	5		Solenoid_Forced	%DB31.DBX726.5			
	6			%DB31.DBX726.6			
	7			%DB31.DBX726.7			

Table 31. Output Page 5

Profibus Address		Tagname plc in DB31		PLC Address	Definition	Units	Data type
Byte #	Bit #	Structure	Tagname in structure				
0		OutputPageX	ActiveDataPage	%DB31.DBW310	Active Data Page		Int-16
1							
2		OutputPageX	ATF_HeartBeat	%DB31.DBX312.0	XCell ATF® Heartbeat		Byte
0		OutputPageX	Rem_Profibus	%DB31.DBX312.1	XCell ATF® Remote Mode (Profibus)		
0		OutputPageX	ATF_Trouble	%DB31.DBX312.2	XCell ATF® Common Trouble Alarm		
0		OutputPageX	ATF_Running	%DB31.DBX312.3	XCell ATF® Run Status		
0		OutputPageX	Pump_Alarm_0	%DB31.DBX312.4	Pump Alarm		
0		OutputPageX	Pump_Alarm_1	%DB31.DBX312.5	Power Loss While Pump Running Alarm		
0		OutputPageX	Pump_Alarm_2	%DB31.DBX312.6	P2 High Pressure Alarm		
0		OutputPageX	Rem_OPC	%DB31.DBX312.7	XCell ATF® Remote Mode (OPC)		
3		OutputPage5	FCCT	%DB31.DBD728	Flow Calculated Cycle Time		Real
4							
5							
6							
7		OutputPage5	FACT	%DB31.DBD732	Flow Actual Cycle Time		Real
8							
9							
10							
11		OutputPage5	ECCT	%DB31.DBD736	Exhaust Calculated Cycle Time		Real
12							
13							
14							
15		OutputPage5	EACT	%DB31.DBD740	Exhaust Actual Cycle Time		Real
16							
17							
18							
19		OutputPage5	TRENDTIME	%DB31.DBD744	Trend Time Base		Real
20							
21							
22							
23		OutputPage5	S2TMREAL	%DB31.DBD748	STATE 2 Timer		Real
24							
25							
26							
27		OutputPage5	S5TMREAL	%DB31.DBD752	STATE 5 Timer		Real
28							
29							
30							
31		OutputPage5	S2DUR	%DB31.DBD756	STATE 2 Duration		Int-32
32							
33							
34							
35		OutputPage5	S5DUR	%DB31.DBD760	STATE 5 Duration		Int-32
36							
37							
38							
39		OutputPage5	CYCLENO	%DB31.DBD764	Batch Cycle Count		Int-32
40							
41							
42							

Profibus Address		Tagname plc in DB31		PLC Address	Definition	Units	Data type
Byte #	Bit #	Structure	Tagname in structure				
43		OutputPage5	TOTAL_CYCLEN0	%DB31.DBD768	Total Cycle Count (Can only be reset by service)		Int-32
44							
45							
46							
47		OutputPage5	APC_PFlowPrimary	%DB31.DBD772	Algorithm Performance Counter - P-Flow - Primary		Int-32
48							
49							
50							
51		OutputPage5	APC_VFlowPrimary	%DB31.DBD776	Algorithm Performance Counter - V-Flow - Primary		Int-32
52							
53							
54							
55							
56							
57							
58							
59							
60							
61							
62							
63							

15. Appendix 6: Delta V example configuration

This example shows a Siemens CM 1242-5 card (slave module) being added to a Delta V controller configuration.

15.1 Install the GSD File in Delta V Explorer

Open under the DeltaV_System, Library > Device Definitions > Profibus Devices. Select Add Device Definition.

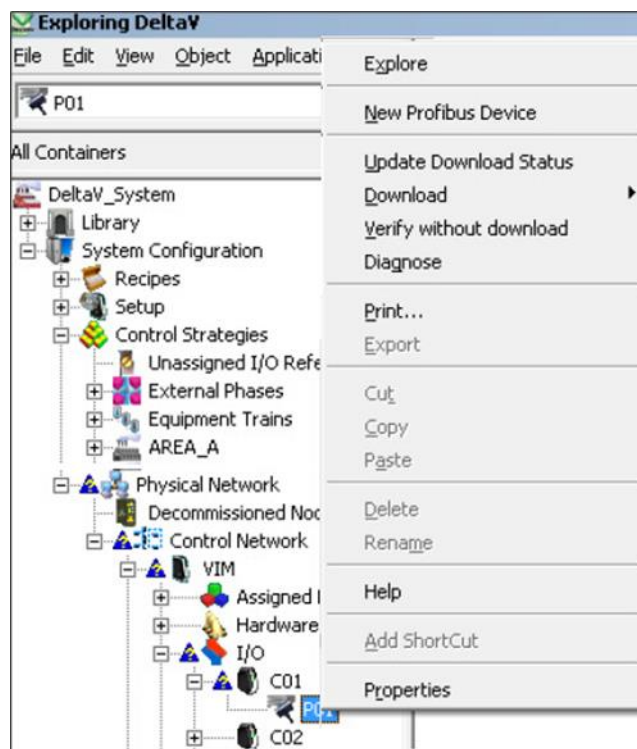

15.2 Add new Profibus Device

Open under the DeltaV_System, System Configuration > Physical Network > Control Network > VIM > I/O > C01 > P01. Select New Profibus Device.

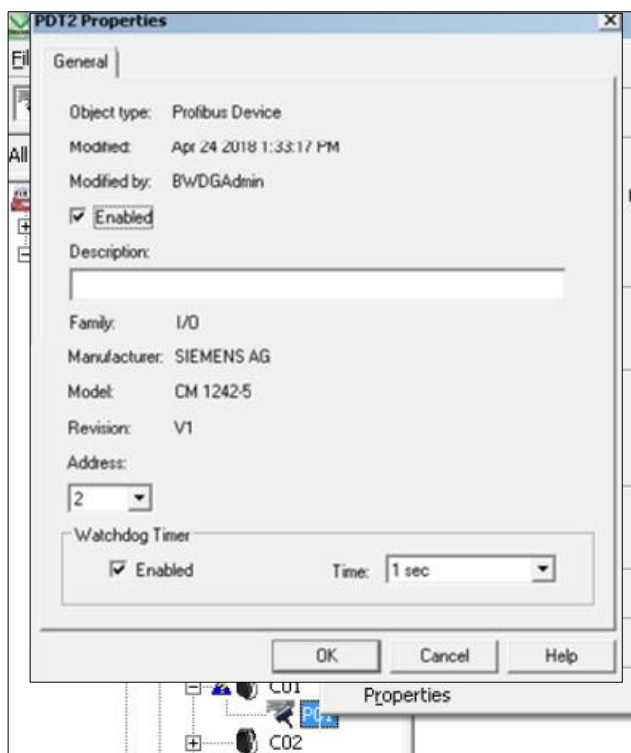

15.3 Select Profibus Device type

Select the correct Profibus type (Generated by the GSD file). In this case a Siemens CM 1242-5 card is shown.

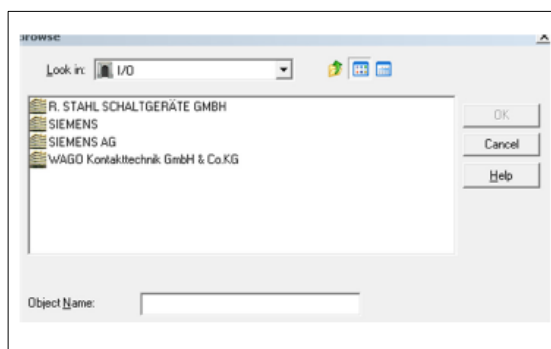

15.4 Address Setting

Verify that the Enabled checkbox is checked and the Address field matches the Address set on the Admin page on the HMI.

Confirm and Select OK button.

15.5 Verify Enabled

If this is the first device on the Profibus Card, reopen the port and verify that the enabled checkbox is checked.

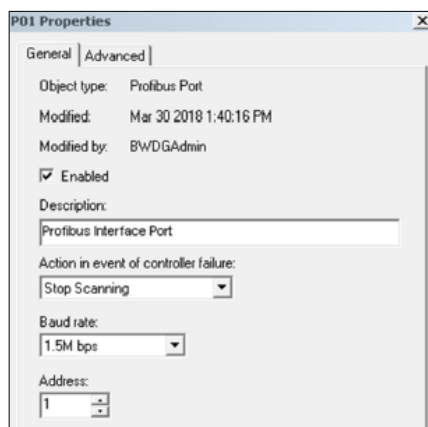

15.6 Create Slot

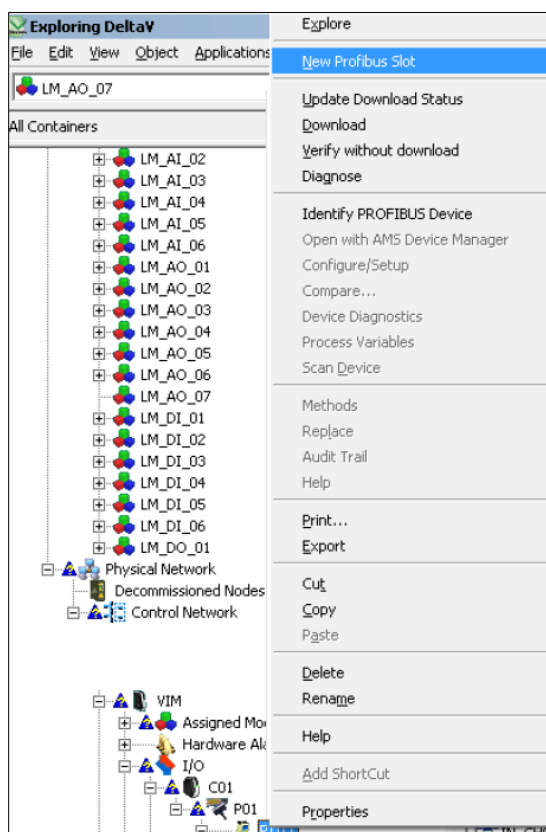

Create a New Profibus Slot for the new Profibus Device.

15.7 Set Slot size

In Delta V the Slot size can be 1, 2, 4, 8, 16, 20 or 64 bytes or words. The largest is 64 words (or 128 bytes). For the XCell ATF® Technology:

- Slot 1 (Module number 1) needs to be a 64 Byte Output (or XCell™ C410:V4B Controller Inputs)
- Slot 2 (Module number 2) needs to be a 64 Byte Input (or XCell™ C410:V4B Controller Outputs)

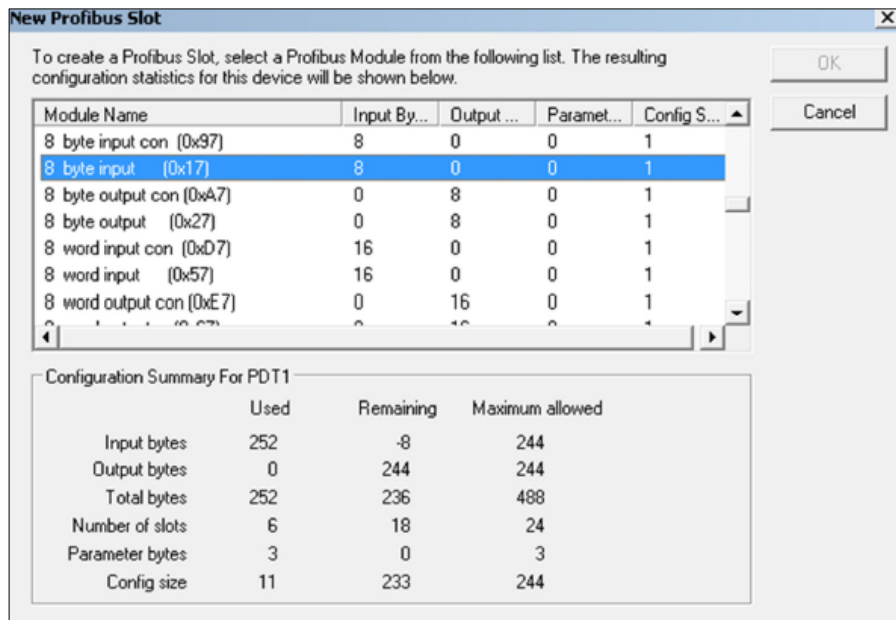

15.8 Verify communications are functioning

With the systems powered up and the Profibus cables connected, communication can be established and confirmed.

Figure 24. Siemens Indication



Green LED(s) illuminate on the slave device(s) even if signals are not created in the slot.

15.9 Create signals

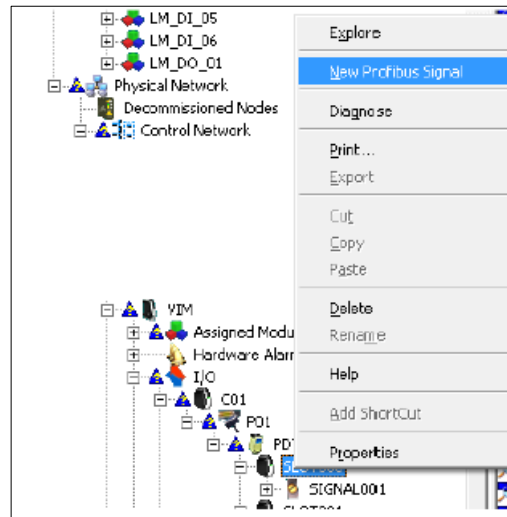

In the Delta V Slot, create a New Profibus Signal.

15.10 Create a Real datatype tag

For a Real tag to be read from the XCell™ C410:V4B Controller, select the Data Type: Floating Point.

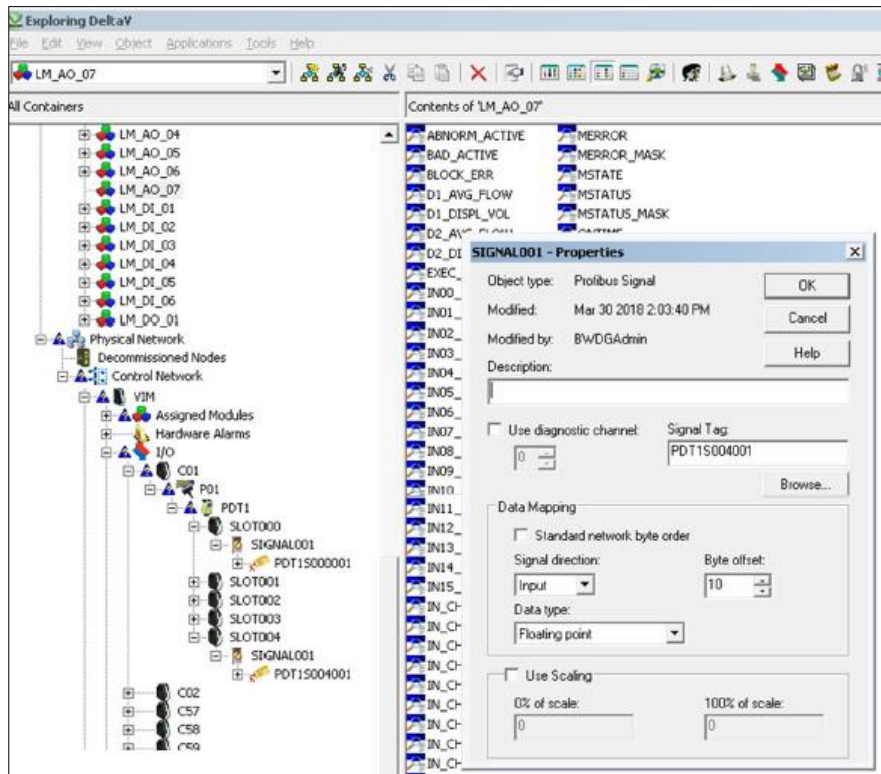

Standard network Byte order should be **checked for Siemens** to provide the correct endian order for Delta V.

This Appendix is intended to provide some limited guidance to an experience Delta V controls professional to avoid standard configuration inquiries which has been experienced by previous integrators.

16. Appendix 7: OPC communication

XCell ATF® Operations- Remote Monitoring and Data Acquisition

The following diagram shows the network architecture for controlling the XCell ATF® Device from an OPC Server and OPC Client Software over a Profinet® (or Ethernet) Cable provided:

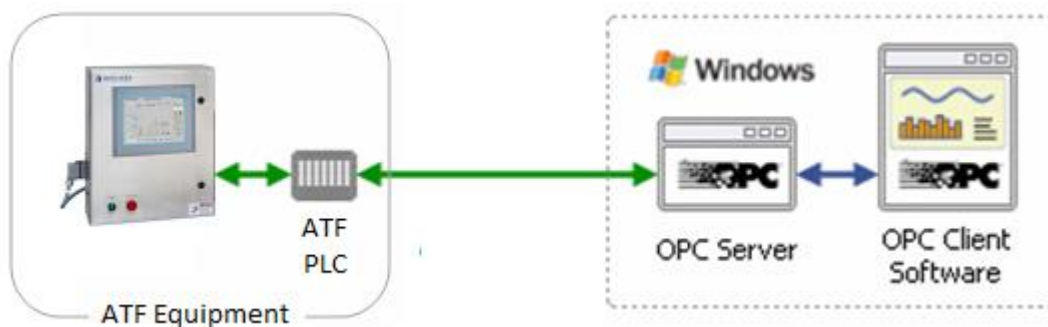

The OPC Client Software is any OPC capable program that will connect through the OPC Server to the XCell ATF® Technology. The OPC Client Software will Control the XCell ATF® Technology remotely and/or read the status of the XCell ATF® Device. Examples of OPC Client Software include Microsoft Excel, WinCC HMI by Siemens, and FactoryTalk® View HMI by Rockwell Automation.

- The acronym OPC comes from OLE (Object Linking and Embedding) for Process Control. Since OLE is based on the Windows COM (Component Object Model) standard, under the hood OPC is essentially COM. Over a network, OPC relies on DCOM (Distributed COM), which was not designed for real-time industrial applications and is often set aside in favor of OPC tunneling.
- OPC is implemented in Server/Client pairs. The OPC Server is a software application that bridges the communication of the PLC with the Windows environment and then with the OPC Client Software application. Some common OPC Server program suppliers include Delta Logic (OPC Server and Data Logger) and Siemens (WinCC Siemens).
- OPC is currently known as Open Platform Communications. The XCell™ C410:V4B Controller uses the provided Ethernet (Profinet®) platform port to connect to an OPC server (master).
- OPC also comprises several standards including OPC Data Access (OPC DA) and other standards for alarms and events, historical data, batch data and XML.

The XCell™ C410:V4B Controller is capable of remote operation using the standard Ethernet (Profinet®) port onboard, enabling communication to an OPC server (master customer). To activate this control mode, the selector switch on the Administrator screen must be toggled to OPC. See *section F.2 Basic Administration Screen (Remote Mode Connection) selector switch*.

16.1 Remote Control Mode

It is possible to set the XCell ATF® Device to Remote Control Mode from the main screen. With the control mode set to Remote, the XCell ATF® Device uses parameters sent from the OPC server master. When set to Local parameters may be entered from the local Human Machine Interface. Instead of using the onboard HMI (operator interface), the Remote con XCell ATF® Device functions, as well as receive feedback from the XCell™ C410:V4B Controller regarding the XCell ATF® Device status and data acquisition for historical purposes.

16.2 Input Signals (from Master to XCell ATF®)

The master, a system with an OPC server sends output data to the slave device (XCell ATF® Device) in its configuration, which becomes input for the XCell™ C410:V4B Controller. The input signals from Master to XCell ATF® Device are directly written to the Input data block parameters defined in Input Signals (from Master to XCell ATF® Device) tables (provided the system is in remote control mode and the selector switch is set to OPC). Unlike the Profibus communications, which is divided into several pages, all OPC parameters are contained within one data block and each parameter can be sent individually. When programming commands to the XCell™ C410:V4B Controller, it is recommended to leave parameters at their previous values to avoid sudden changes.

16.3 Output Signals (to Master from XCell ATF® Device)

The slave device (XCell ATF® Device) provides output data, which becomes inputs for the master. The output signals from the XCell ATF® Device are updated every PLC scan. The parameters are defined in Output Signals (from XCell ATF® Device to Master) tables to the OPC outputs. The XCell ATF® heartbeat is provided, so the Master can continually monitor the communication integrity.

16.4 OPC Configuration for DCS integration

The XCell™ C410:V4B Controller is configured as a slave OPC client; at the (default) IP address stated in the Profinet® section of this user guide. The XCell™ C410:V4B Controller is Siemens S7-1200 PLC.

The IP address can be changed to match customer requirements. Both the PLC and HMI IP address must be on the same subnet and be set to communicate with each other. For factory default settings and method to make changes.

16.5 Black-Box configuration

Black-box configuration is similar to remote control mode but allows completely remote operation of the XCell ATF® Device with HMI disabled at the factory. Black-box configuration can be requested at time of ordering a new system.

16.6 Prerequisites

The XCell ATF® Device should be calibrated and connected to a bioreactor or other vessel. The XCell ATF® Device should be in a Remote-Control Mode.

16.7 Remote Set-up

The master sends input command and Set-up parameters to XCell ATF® Device or Set-up the parameters locally (on the HMI). The start parameter should be 0. Command parameters are highlighted in light blue in the OPC inputs Table after this section. For the XCell™ C410:V4B Controller to accept these parameters, the CommandApply bit must be set. Similarly, set-up parameters are highlighted in light red and the ConfigurationSave bit must be set.

16.8 Remote Start

The master must send at least values in PFLOWSP, EFLOWSP, PRV1, PRV2, PV1 and PV2 (command parameters) to XCell ATF® Device. The Command Apply bit must be set to 1 for these values to be accepted by the XCell™ C410:V4B Controller. Initially, the Start and Stop bits should be reset 0. The master starts the filtration by setting the Start bit to 1. The XCell ATF® Device starts running. The Start bit can be reset to 0 after the ATF_Running bit is set and received from the XCell™ C410:V4B Controller.

16.9 Remote Stop

The master stops the filtration by setting the Stop bit to 1. The XCell ATF® Device stops running. The Stop bit can be reset to 0 after the ATF_Running bit is reset and received from the XCell™ C410:V4B Controller.

16.10 Remote running

During a run it is possible to change all parameters remotely.

If the XCell ATF® Device is changed from Remote Control Mode to Local Control Mode, it continues to run, and it is possible to stop the run from the HMI. If the filtration has been stopped locally and then changed back to Remote Control Mode, it will not restart. To restart the filtration the master must perform the items listed in Remote Start described earlier in this section.

16.11 System-stop

If the XCell ATF® Device is stopped by the System-stop (one of 2 blue buttons on either the Pneumatic Enclosure or Electronics Box), and the System-stop is reset, the XCell ATF® Device will not restart. The master must perform the items listed in Remote Start described earlier in this section to restart the filtration. System-stop is indicated visually with the buttons illuminated, via `DL_WARN_REG[5] = true`. The `DL_WARN_REG[5]` is not reset until a new start sequence is performed as described in the Remote Start section.

16.12 Calibration process

When not running, calibration activities can be performed.

calibration parameters and commands are found on the second OPC Inputs (continued) page. The master sends enable, capture and accept commands as well as high and low scaling parameters to perform calibration activities, or calibration can be performed via the HMI. Repligen recommends

having a service technician perform calibration activities. Once loop calibration is initiated, it must complete the calibration process. There is currently no means to disable an enabled calibration without completing the process via remote commands. Only one input loop shall be calibrated at a time. Each loop shall be calibrated in its entirety by itself, without enabling (or initiating) the calibration of another loop. The process of calibration is a 2-point linear scaling process, where a technician first confirms all required utilities, external pressure gauge and loop wiring is connected. The following steps are performed:

1. An enable bit is momentarily asserted. Controller is enabled in calibration mode for a particular analog input.
2. Pneumatic devices are set to produce a minimum setting. The pressure in the system approaches the minimum value commanded. Pressure gauge reading is allowed to stabilize.
3. The pressure gauge reading is provided to the controller. A minimum capture bit is momentarily asserted.
4. Pneumatic devices are set to produce a maximum setting. The value on the pressure gauge is allowed to stabilize.
5. The pressure gauge reading is provided to the controller. A maximum capture bit is momentarily asserted.
6. Once both minimum and maximum points are captured, the linear scaling calculation can be performed by the PLC. This calculation is initiated by setting an accept bit (momentarily asserted). Controller performs the linear scaling calculation and resets the controller's internal calibration enable bit.

16.13 Calibration example

Technician calibrates the P2 pressure sensor.

1. Assert enable bit:
 - a. Set P2_Cal_Enable (input command bit) = 1 until P2_Cal_Enable (output response bit) is set (= 1) and is received. When true.
 - b. Reset P2_Cal_Enable = 0.
 - c. Controller is enabled in calibration mode for P2 analog input.
2. Pneumatic devices are set to produce a minimum setting. (PV2=100%, PRV2=-5.00 PSI, Solenoid=0 [vacuum].)
 - d. While SendingDataPage is still equal to 3...
 - e. Set PV2_SP (input) = 100 Confirmed by examining DL_PV2 (output).
 - f. Set PRV2_SP (input) = -5. Confirmed by examining DL_PRV2 (output).
 - g. Reset Force_Solenoid (input) = 0. Confirmed by examining Solenoid_Forced (output)
 - h. The pressure in the system approaches the minimum value commanded. Pressure gauge reading is allowed to stabilize.

Note: P2_PV and PRV2_PV should be very near the value on the external pressure gauge.

3. Pressure gauge reading is provided to the controller.
 - i. Programmer provides a data entry location for technician to *enter the pressure value*.
 - j. Set P2_P1_EU = *the pressure value from the data entry location*.
 - k. Set P2_P1_Capture = 1 until P2_P1_Captured bit is received. When true.
 - l. Reset P2_P1_Capture = 0; *the minimum capture bit is momentarily asserted*.
4. Pneumatic devices are set to produce a maximum setting. (PV1=100%, PRV1=20.00 PSI, Solenoid=1 [pressure or air]).
 - m. Set PV1_SP = 100. Confirmed by examining DL_PV1.
 - n. Set PRV1_SP = 2. Confirmed by examining DL_PRV1.
 - o. Set Force_Solenoid = . Confirmed by examining Solenoid_Forced.
 - p. The pressure in the system approaches the maximum value commanded. Pressure gauge reading is allowed to stabilize.

Note: *P2_PV and PRV1_PV should be very near the value on the external pressure gauge.*

5. Pressure gauge reading is provided to the controller.
 - q. Programmer provides another data entry location for technician to *enter the pressure value.*
 - r. Set P2_P2_EU = *the pressure value from the data entry location.*
 - s. Set P2_P2_Capture = 1 until the P2_Cal_Enable bit is received. When true.
 - t. Reset P2_P2_Capture = 0; *the maximum capture bit is momentarily asserted.*
6. Assert accept bit:
 - u. Set P2_Accept (input) = 1 until the P2_Accept (output) bit is received. When true.
 - v. Reset P2_Accept = 0.
 - w. Controller performs the linear scaling calculation and resets the controller's internal calibration enable bit.
7. Clean up: After all calibration activities are complete, be sure to reset parameters that were set during the calibration process.

Table 32. OPC Inputs

Tagname plc in DB41		PLC Address	Definition	Units	Data type
Structure	Tagname in structure				
"DB41".	ATF_START	%DB41.DBX0.0	Command Word – XCell ATF® Start		Bool
"DB41".	ATF_STOP	%DB41.DBX0.1	Command Word – XCell ATF® Stop		Bool
"DB41".	AFT_Ack_Alarms	%DB41.DBX0.2	Command Word - Acknowledge Alarms		Bool
"DB41".	Reset_Counters	%DB41.DBX0.3	Command Word - Algorithm Performance Counters Reset		Bool
"DB41".	ATF_Control_Mode	%DB41.DBX0.4	Command Word – XCell ATF® - Control Mode (Flow/Time)		Bool
"DB41".	ATF_Slope_Enabled	%DB41.DBX0.5	Command Word – XCell ATF® - Slope Enable		Bool
"DB41".	CommandApply	%DB41.DBX0.6	Command Word - Command Apply		Bool
"DB41".	ConfigSave	%DB41.DBX0.7	Command Word - Configuration Save		Bool
"DB41".	ATF_ConnectedBR	%DB41.DBW2	Connected Bioreactor (INT number)		Int
"DB41".	PFLOWSP	%DB41.DBD4	Pressure Flow Setpoint LPM	LPM	Real
"DB41".	PTIMESP	%DB41.DBD8	Pressure Flow Setpoint SEC	SEC	Real
"DB41".	EFLOWSP	%DB41.DBD12	Exhaust Flow Setpoint LPM	LPM	Real
"DB41".	ETIMESP	%DB41.DBD16	Exhaust Flow Setpoint SEC	SEC	Real
"DB41".	PRV1	%DB41.DBD20	Flow Regulator Setpoint (bar)	bar/PSI	Real
"DB41".	PRV2	%DB41.DBD24	Exhaust Regulator Setpoint (bar)	bar/PSI	Real
"DB41".	PV1	%DB41.DBD28	Flow Prop Valve Setpoint (%)	% Open	Real
"DB41".	PV2	%DB41.DBD32	Exhaust Prop Valve Setpoint (%)	% Open	Real
"DB41".	BatchName[0]	%DB41.DBB36	Batch name, 5 Char (bytes)		Char
"DB41".	BatchName[1]	%DB41.DBB37	Batch name, 5 Char (bytes)		Char
"DB41".	BatchName[2]	%DB41.DBB38	Batch name, 5 Char (bytes)		Char
"DB41".	BatchName[3]	%DB41.DBB39	Batch name, 5 Char (bytes)		Char
"DB41".	BatchName[4]	%DB41.DBB40	Batch name, 5 Char (bytes)		Char
"DB41".	Model_Num_HMI	%DB41.DBW42	Model Number SP		Int
"DB41".	WATSP	%DB41.DBW44	Warning/Alarm Acknowledge Delay Time SP	Min	Int
"DB41".	Bioreactor_Backpressure	%DB41.DBD46	Bioreactor Backpressure	bar/PSI	Real
"DB41".	Height_Differential	%DB41.DBW50	Height Differential SP	CM	Int
"DB41".	FDFOFST	%DB41.DBD52	Flow Driving Force Offset for switching	bar/PSI	Real
"DB41".	Press_Cycle_Delay_Time_SP	%DB41.DBW56	Pressure Cycle Delay Time SP	Stroke %	Int
"DB41".	Press_Cycle_Over_Time_SP	%DB41.DBW58	Pressure Cycle Over Time SP	Stroke %	Int
"DB41".	Pres_Cycl_PV_Step_Size	%DB41.DBD60	Pressure Cycle - PV Step Size - %	Stroke %	Real
"DB41".	EDFOFST	%DB41.DBD64	Exhaust Driving Force Offset for switching	bar/PSI	Real
"DB41".	Vac_Cycle_Delay_Time_SP	%DB41.DBW68	Vacuum Cycle Delay Time SP	Stroke %	Int
"DB41".	Vac_Cycle_Over_Time_SP	%DB41.DBW70	Vacuum Cycle Over Time SP	Stroke %	Int
"DB41".	Exhs_Cycl_PV_Step_Size	%DB41.DBD72	Exhaust Cycle - PV Step Size - %	Stroke %	Real
"DB41".	P2_Pressure_Alarm_Hi_Hi_SP	%DB41.DBD76	P2 Alarm Limit Hi Set Point	bar/PSI	Real
"DB41".	P2_Alarm_Hi_Hi_TMR_SP	%DB41.DBW80	P2 Pressure Alarm Hi - Timer SP	SEC	Int
"DB41".	P2_Pressure_Alarm_Lo_Lo_SP	%DB41.DBD82	P2 Alarm Limit Lo Set Point	bar/PSI	Real
"DB41".	P2_Alarm_Lo_Lo_TMR_SP	%DB41.DBW86	P2 Pressure Alarm Lo - Timer SP	SEC	Int
"DB41".	PFLOWMAXSP	%DB41.DBD88	Max Pressure Flow Setpoint LPM	LPM	Real
"DB41".	PFLOWMINSP	%DB41.DBD92	Min Pressure Flow Setpoint LPM	LPM	Real
"DB41".	EFLOWMAXSP	%DB41.DBD96	Max Exhaust Flow Setpoint LPM	LPM	Real
"DB41".	EFLOWMINSP	%DB41.DBD100	Min Exhaust Flow Setpoint LPM	LPM	Real
"DB41".	PTIMEMAXSP	%DB41.DBD104	Max Pressure Flow Setpoint SEC	SEC	Real
"DB41".	PTIMEMINSP	%DB41.DBD108	Min Pressure Flow Setpoint SEC	SEC	Real
"DB41".	ETIMEMAXSP	%DB41.DBD112	Max Exhaust Flow Setpoint SEC	SEC	Real
"DB41".	ETIMEMINSP	%DB41.DBD116	Min Exhaust Flow Setpoint SEC	SEC	Real
"DB41".	PV1MAX	%DB41.DBD120	Flow Prop Valve Max Value (%)	% Open	Real
"DB41".	PV1MIN	%DB41.DBD124	Flow Prop Valve Min Value (%)	% Open	Real
"DB41".	PV2MAX	%DB41.DBD128	Exhaust Prop Valve Max Value (%)	% Open	Real
"DB41".	PV2MIN	%DB41.DBD132	Exhaust Prop Valve Min Value (%)	% Open	Real
"DB41".	PRV1MAX	%DB41.DBD136	Flow Regulator Max Value (bar)	bar/PSI	Real
"DB41".	PRV1MIN	%DB41.DBD140	Flow Regulator Min Value (bar)	bar/PSI	Real
"DB41".	PRV2MAX	%DB41.DBD144	Exhaust Regulator Max Value (bar)	bar/PSI	Real
"DB41".	PRV2MIN	%DB41.DBD148	Exhaust Regulator Min Value (bar)	bar/PSI	Real

Light Blue highlighted inputs are activated when CommandApply bit is set.

Light Red highlighted inputs are activated when ConfigurationSave bit is set.

Tagname plc in DB41		PLC Address	Definition	Units	Data type
Structure	Tagname in structure				
"DB41".	P2_Cal_Enable	%DB41.DBX152.0			Bool
"DB41".	PRV1_Cal_Enable	%DB41.DBX152.1			Bool
"DB41".	PRV2_Cal_Enable	%DB41.DBX152.2			Bool
"DB41".	P3_Cal_Enable	%DB41.DBX152.3			Bool
"DB41".	P4_Cal_Enable	%DB41.DBX152.4			Bool
"DB41".	P5_Cal_Enable	%DB41.DBX152.5			Bool
"DB41".	W1_Cal_Enable	%DB41.DBX152.6			Bool
"DB41".	P2_P1_Capture	%DB41.DBX152.7			Bool
"DB41".	P2_P2_Capture	%DB41.DBX153.0			Bool
"DB41".	P2_Accept	%DB41.DBX153.1			Bool
"DB41".	PRV1_P1_Capture	%DB41.DBX153.2			Bool
"DB41".	PRV1_P2_Capture	%DB41.DBX153.3			Bool
"DB41".	PRV1_Accept	%DB41.DBX153.4			Bool
"DB41".	PRV2_P1_Capture	%DB41.DBX153.5			Bool
"DB41".	PRV2_P2_Capture	%DB41.DBX153.6			Bool
"DB41".	PRV2_Accept	%DB41.DBX153.7			Bool
"DB41".	P3_P1_Capture	%DB41.DBX154.0			Bool
"DB41".	P3_P2_Capture	%DB41.DBX154.1			Bool
"DB41".	P3_Accept	%DB41.DBX154.2			Bool
"DB41".	P4_P1_Capture	%DB41.DBX154.3			Bool
"DB41".	P4_P2_Capture	%DB41.DBX154.4			Bool
"DB41".	P4_Accept	%DB41.DBX154.5			Bool
"DB41".	P5_P1_Capture	%DB41.DBX154.6			Bool
"DB41".	P5_P2_Capture	%DB41.DBX154.7			Bool
"DB41".	P5_Accept	%DB41.DBX155.0			Bool
"DB41".	W1_P1_Capture	%DB41.DBX155.1			Bool
"DB41".	W1_P2_Capture	%DB41.DBX155.2			Bool
"DB41".	W1_Accept	%DB41.DBX155.3			Bool
"DB41".	Force_Solenoid	%DB41.DBX155.4			Bool
"DB41".	PV1_SP	%DB41.DBD156			Real
"DB41".	PV2_SP	%DB41.DBD160			Real
"DB41".	PRV1_SP	%DB41.DBD164			Real
"DB41".	PRV2_SP	%DB41.DBD168			Real
"DB41".	P2_P1_EU	%DB41.DBD172	Calibration - AIW04 - Point 1 - Engineering Value	bar	Real
"DB41".	P2_P2_EU	%DB41.DBD176	Calibration - AIW04 - Point 2 - Engineering Value	bar	Real
"DB41".	PRV1_P1_EU	%DB41.DBD180	Calibration - AIW06 - Point 1 - Engineering Value	bar	Real
"DB41".	PRV1_P2_EU	%DB41.DBD184	Calibration - AIW06 - Point 2 - Engineering Value	bar	Real
"DB41".	PRV2_P1_EU	%DB41.DBD188	Calibration - AIW08 - Point 1 - Engineering Value	bar	Real
"DB41".	PRV2_P2_EU	%DB41.DBD192	Calibration - AIW08 - Point 2 - Engineering Value	bar	Real
"DB41".	P3_P1_EU	%DB41.DBD196	Calibration - AIW12 - Point 1 - Engineering Value	bar	Real
"DB41".	P3_P2_EU	%DB41.DBD200	Calibration - AIW12 - Point 2 - Engineering Value	bar	Real
"DB41".	P4_P1_EU	%DB41.DBD204	Calibration - AIW14 - Point 1 - Engineering Value	bar	Real
"DB41".	P4_P2_EU	%DB41.DBD208	Calibration - AIW14 - Point 2 - Engineering Value	bar	Real
"DB41".	P5_P1_EU	%DB41.DBD212	Calibration - AIW16 - Point 1 - Engineering Value	bar	Real
"DB41".	P5_P2_EU	%DB41.DBD216	Calibration - AIW16 - Point 2 - Engineering Value	Kg	Real
"DB41".	W1_P1_EU	%DB41.DBD220	Calibration - AIW18 - Point 1 - Engineering Value	Kg	Real

Table 33. OPC Outputs

Structure	Tagname plc in DB40		PLC Address	Definition	Units	Data type
	Tagname in structure					
"DB40".	DB40_DataLog.DL_BATCH_NO		P#DB40.DBX0.0	Batch Number		String
"DB40".	DB40_DataLog.DL_CYCLEN0		%DB40.DBD256	Batch Cycle Count		DInt
"DB40".	DB40_DataLog.DL_TOTAL_CYCLEN0		%DB40.DBD260	Total Cycle Count (resettable by Service)		DInt
"DB40".	DB40_DataLog.DL_ALARM_REG[0]		%DB40.DBX264.0			Bool
"DB40".	DB40_DataLog.DL_ALARM_REG[1]		%DB40.DBX264.1			Bool
"DB40".	DB40_DataLog.DL_ALARM_REG[2]		%DB40.DBX264.2			Bool
"DB40".	DB40_DataLog.DL_WARN_REG[0]		%DB40.DBX266.0			Bool
"DB40".	DB40_DataLog.DL_WARN_REG[1]		%DB40.DBX266.1			Bool
"DB40".	DB40_DataLog.DL_WARN_REG[2]		%DB40.DBX266.2			Bool
"DB40".	DB40_DataLog.DL_WARN_REG[3]		%DB40.DBX266.3			Bool
"DB40".	DB40_DataLog.DL_WARN_REG[4]		%DB40.DBX266.4			Bool
"DB40".	DB40_DataLog.DL_WARN_REG[5]		%DB40.DBX266.5			Bool
"DB40".	DB40_DataLog.DL_PLC_Version		%DB40.DBD268	PLC Software Version		Real
"DB40".	DB40_DataLog.DL_PRV1		%DB40.DBD272	Flow Regulator Value	bar/PSI	Real
"DB40".	DB40_DataLog.DL_PRV1MAX		%DB40.DBD276	Flow Regulator Value Max Value	bar/PSI	Real
"DB40".	DB40_DataLog.DL_PRV1MIN		%DB40.DBD280	Flow Regulator Value Min Value	bar/PSI	Real
"DB40".	DB40_DataLog.DL_PV1		%DB40.DBD284	Flow Prop Valve Value	% Open	Real
"DB40".	DB40_DataLog.DL_PV1MAX		%DB40.DBD288	Flow Prop Valve Max Value	% Open	Real
"DB40".	DB40_DataLog.DL_PV1MIN		%DB40.DBD292	Flow Prop Valve Max Value	% Open	Real
"DB40".	DB40_DataLog.DL_PRV2		%DB40.DBD296	Flow Prop Valve Max Value	bar/PSI	Real
"DB40".	DB40_DataLog.DL_PRV2MAX		%DB40.DBD300	Flow Prop Valve Max Value	bar/PSI	Real
"DB40".	DB40_DataLog.DL_PRV2MIN		%DB40.DBD304	Flow Prop Valve Max Value	bar/PSI	Real
"DB40".	DB40_DataLog.DL_PV2		%DB40.DBD308	Exhaust Prop Valve Value	% Open	Real
"DB40".	DB40_DataLog.DL_PV2MAX		%DB40.DBD312	Exhaust Prop Valve Max Value	% Open	Real
"DB40".	DB40_DataLog.DL_PV2MIN		%DB40.DBD316	Exhaust Prop Valve Min Value	% Open	Real
"DB40".	DB40_DataLog.DL_PFLOW		%DB40.DBD320	Pressure Flow LPM	LPM	Real
"DB40".	DB40_DataLog.DL_PFLOWSP		%DB40.DBD324	Pressure Flow Setpoint LPM	LPM	Real
"DB40".	DB40_DataLog.DL_PFLOWMAXSP		%DB40.DBD328	Max Pressure Flow Setpoint LPM	LPM	Real
"DB40".	DB40_DataLog.DL_PFLOWMINSP		%DB40.DBD332	Min Pressure Flow Setpoint LPM	LPM	Real
"DB40".	DB40_DataLog.DL_EFLOW		%DB40.DBD336	Exhaust Flow LPM	LPM	Real
"DB40".	DB40_DataLog.DL_EFLOWSP		%DB40.DBD340	Exhaust Flow Setpoint LPM	LPM	Real
"DB40".	DB40_DataLog.DL_EFLOWMAXSP		%DB40.DBD344	Max Exhaust Flow Setpoint LPM	LPM	Real
"DB40".	DB40_DataLog.DL_EFLOWMINSP		%DB40.DBD348	Min Exhaust Flow Setpoint LPM	LPM	Real
"DB40".	DB40_DataLog.DL_PTIME		%DB40.DBD352	Pressure Flow SEC	SEC	Real
"DB40".	DB40_DataLog.DL_PTIMESP		%DB40.DBD356	Pressure Flow Setpoint SEC	SEC	Real
"DB40".	DB40_DataLog.DL_PTIMEMAXSP		%DB40.DBD360	Max Pressure Flow Setpoint SEC	SEC	Real
"DB40".	DB40_DataLog.DL_PTIMEMINSP		%DB40.DBD364	Min Pressure Flow Setpoint SEC	SEC	Real
"DB40".	DB40_DataLog.DL_ETIME		%DB40.DBD368	Exhaust Flow SEC	SEC	Real
"DB40".	DB40_DataLog.DL_ETIMESP		%DB40.DBD372	Exhaust Flow Setpoint SEC	SEC	Real
"DB40".	DB40_DataLog.DL_ETIMESP		%DB40.DBD372	Exhaust Flow Setpoint SEC	SEC	Real
"DB40".	DB40_DataLog.DL_ETIMEMINSP		%DB40.DBD380	Min Exhaust Flow Setpoint SEC	SEC	Real
"DB40".	DB40_DataLog.DL_TRENDTIME		%DB40.DBD384	Trend Time Base		Real
"DB40".	DB40_DataLog.DL_S2TMREAL		%DB40.DBD388	STATE 2 Timer (Real)		Real
"DB40".	DB40_DataLog.DL_S5TMREAL		%DB40.DBD392	STATE 5 Timer (Real)		Real
"DB40".	DB40_DataLog.DL_S2DUR		%DB40.DBD396	STATE 2 Duration (10ms)	10msec	DInt
"DB40".	DB40_DataLog.DL_S5DUR		%DB40.DBD400	STATE 5 Duration (10ms)	10msec	DInt
"DB40".	DB40_DataLog.DL_FDFOFST		%DB40.DBD404	Flow Driving Force Offset for switching	bar/PSI	Real
"DB40".	DB40_DataLog.DL_EDFOFST		%DB40.DBD408	Exhaust Driving Force Offset for switching	bar/PSI	Real
"DB40".	DB40_DataLog.DL_FCCT		%DB40.DBD412	Flow Calculated Cycle Time	SEC	Real
"DB40".	DB40_DataLog.DL_FACT		%DB40.DBD416	Flow Actual Cycle Time	SEC	Real
"DB40".	DB40_DataLog.DL_ECCT		%DB40.DBD420	Exhaust Calculated Cycle Time	SEC	Real
"DB40".	DB40_DataLog.DL_EACT		%DB40.DBD424	Exhaust Actual Cycle Time	SEC	Real
"DB40".	DB40_DataLog.DL_FDRVFORCESP		%DB40.DBD428	Flow Driving Pressure SP	bar/PSI	Real
"DB40".	DB40_DataLog.DL_EDRVFORCESP		%DB40.DBD432	Exhaust Driving Pressure SP	bar/PSI	Real
"DB40".	DB40_DataLog.DL_FSOTSP		%DB40.DBD436	Flow Switch Override Timer SP	SEC	DInt
"DB40".	DB40_DataLog.DL_FDFDTSP		%DB40.DBD440	Flow DF Detect Timer SP	SEC	DInt

Structure	Tagname plc in DB40 Tagname in structure	PLC Address	Definition	Units	Data type
"DB40".	DB40_DataLog.DL_ESOTSP	%DB40.DBD444	Exhaust Switch Override Timer SP	SEC	DInt
"DB40".	DB40_DataLog.DL_EDFDTSP	%DB40.DBD448	Exhaust DF Detect Timer SP	SEC	DInt
"DB40".	DB40_DataLog.DL_APC_PFlowPrimary	%DB40.DBW452	Algorithm Performance Counter 0		Int
"DB40".	DB40_DataLog.DL_APC_PFlowOverride	%DB40.DBW454	Algorithm Performance Counter 1		Int
"DB40".	DB40_DataLog.DL_APC_PFlowOvertime	%DB40.DBW456	Algorithm Performance Counter 2		Int
"DB40".	DB40_DataLog.DL_APC_VFlowPrimary	%DB40.DBW458	Algorithm Performance Counter 3		Int
"DB40".	DB40_DataLog.DL_APC_VFlowOverride	%DB40.DBW460	Algorithm Performance Counter 4		Int
"DB40".	DB40_DataLog.DL_APC_VFlowOvertime	%DB40.DBW462	Algorithm Performance Counter 5		Int
"DB40".	DB40_DataLog.DL_P2_PV	%DB40.DBD464	P2 - Process Value	Bar/PSI	Real
"DB40".	DB40_DataLog.DL_PRV1_PV	%DB40.DBD468	PRV1 - Process Value	Bar/PSI	Real
"DB40".	DB40_DataLog.DL_PRV2_PV	%DB40.DBD472	PRV2 - Process Value	Bar/PSI	Real
"DB40".	DB40_DataLog.DL_SPARE_PV	%DB40.DBD476	Spare - Process Value		Real
"DB40".	DB40_DataLog.DL_P3_PV	%DB40.DBD480	P3 - Process Value	Bar/PSI	Real
"DB40".	DB40_DataLog.DL_P4_PV	%DB40.DBD484	P4 - Process Value	Bar/PSI	Real
"DB40".	DB40_DataLog.DL_P5_PV	%DB40.DBD488	P5 - Process Value	Bar/PSI	Real
"DB40".	DB40_DataLog.DL_W1_PV	%DB40.DBD492	W1 - Process Value	Kg	Real
"DB40".	DB40_DataLog.DL_Bioreactor_Backpressure	%DB40.DBD496	Bioreactor Backpressure	Bar/PSI	Real
"DB40".	DB40_DataLog.DL_Model_Num_HMI	%DB40.DBW500	Model Number SP		Int
"DB40".	DB40_DataLog.DL_Height_Differential	%DB40.DBW502	Height Differential SP	CM	Int
"DB40".	DB40_DataLog.DL_Press_Cycle_Delay_Time_SP	%DB40.DBW504	Pressure Cycle Delay Time SP	SEC	Int
"DB40".	DB40_DataLog.DL_Press_Cycle_Over_Time_SP	%DB40.DBW506	Pressure Cycle Over Time SP	SEC	Int
"DB40".	DB40_DataLog.DL_Vac_Cycle_Delay_Time_SP	%DB40.DBW508	Vacuum Cycle Delay Time SP	SEC	Int
"DB40".	DB40_DataLog.DL_BATCH_NO	P#DB40.DBX0.0	Batch Number		String
"DB40".	ATF_HeartBeat	%DB40.DBX512.0	XCell ATF® Heartbeat 1 Sec Cycle 50% Duty		Bool
"DB40".	Rem_PB	%DB40.DBX512.1	XCell ATF® Remote Profibus Master		Bool
"DB40".	Rem_OPC	%DB40.DBX512.2	XCell ATF® Remote OPC Master		Bool
"DB40".	ATF_Trouble	%DB40.DBX512.3	XCell ATF® Common Trouble Alarm		Bool
"DB40".	ATF_Running	%DB40.DBX512.4	XCell ATF® Status is Running		Bool
"DB40".	ATF_START	%DB40.DBX514.0	AFT Start Command		Bool
"DB40".	ATF_STOP	%DB40.DBX514.1	XCell ATF® Stop Command		Bool
"DB40".	ATF_Ack_Alarms	%DB40.DBX514.2	XCell ATF® Acknowledge Alarms		Bool
"DB40".	Reset_Counters	%DB40.DBX514.3	Algorithm Performance Counters - Reset		Bool
"DB40".	ATF_Control_Mode	%DB40.DBX514.4	Control Mode		Bool
"DB40".	ATF_Slope_Enabled	%DB40.DBX514.5	Slope Function Enabled		Bool
"DB40".	DL_ATF_Connected_Bioreactor	%DB40.DBW516	XCell ATF® Connected Bioreactor		Int
"DB40".	DL_WATSP	%DB40.DBW518	Warning / Alarm Timer SP	Min	Int
"DB40".	DL_Pres_Cycl_PV_Step_Size	%DB40.DBD520	Pressure Cycle - PV Step Size - %	Stroke %	Real
"DB40".	DL_Exhs_Cycl_PV_Step_Size	%DB40.DBD524	Exhaust Cycle - PV Step Size	bar/PSI	Real
"DB40".	DL_P2_Pressure_Alarm_Hi_Hi_SP	%DB40.DBD528	P2 - Alarm SP - High	bar/PSI	Real
"DB40".	DL_P2_Alarm_Hi_Hi_TMR_SP	%DB40.DBW532	P2 - Alarm Delay SP - High	SEC	Int
"DB40".	DL_P2_Pressure_Alarm_Lo_Lo_SP	%DB40.DBD534	P2 - Alarm SP - Low	bar/PSI	Real
"DB40".	DL_P2_Alarm_Lo_Lo_TMR_SP	%DB40.DBW538	P2 - Alarm Delay SP - Low	SEC	Int

Table 34. OPC Outputs (Calibration parameters)

Structure	Tagname plc in DB40		PLC Address	Definition	Units	Data Type
	Tagname in structure					
"DB40".	P2_Cal_Enabled		%DB40.DBX540.0	P2 Cal Select Button		Bool
"DB40".	PRV1_Cal_Enabled		%DB40.DBX540.1	PRV1 Cal Select Button		Bool
"DB40".	PRV2_Cal_Enabled		%DB40.DBX540.2	PRV2 Cal Select Button		Bool
"DB40".	P3_Cal_Enabled		%DB40.DBX540.3	P3 Cal Select Button		Bool
"DB40".	P4_Cal_Enabled		%DB40.DBX540.4	P4 Cal Select Button		Bool
"DB40".	P5_Cal_Enabled		%DB40.DBX540.5	P5 Cal Select Button		Bool
"DB40".	W1_Cal_Enabled		%DB40.DBX540.6	W1 Cal Select Button		Bool
"DB40".	P2_P1_Captured		%DB40.DBX540.7			Bool
"DB40".	P2_P2_Captured		%DB40.DBX541.0			Bool
"DB40".	P2_Accepted		%DB40.DBX541.1			Bool
"DB40".	PRV1_P1_Captured		%DB40.DBX541.2			Bool
"DB40".	PRV1_P2_Captured		%DB40.DBX541.3			Bool
"DB40".	PRV1_Accepted		%DB40.DBX541.4			Bool
"DB40".	PRV2_P1_Captured		%DB40.DBX541.5			Bool
"DB40".	PRV2_P2_Captured		%DB40.DBX541.6			Bool
"DB40".	PRV2_Accepted		%DB40.DBX541.7			Bool
"DB40".	P3_P1_Captured		%DB40.DBX542.0			Bool
"DB40".	P3_P2_Captured		%DB40.DBX542.1			Bool
"DB40".	P3_Accepted		%DB40.DBX542.2			Bool
"DB40".	P4_P1_Captured		%DB40.DBX542.3			Bool
"DB40".	P4_P2_Captured		%DB40.DBX542.4			Bool
"DB40".	P4_Accepted		%DB40.DBX542.5			Bool
"DB40".	P5_P1_Captured		%DB40.DBX542.6			Bool
"DB40".	P5_P2_Captured		%DB40.DBX542.7			Bool
"DB40".	P5_Accepted		%DB40.DBX543.0			Bool
"DB40".	W1_P1_Captured		%DB40.DBX543.1			Bool
"DB40".	W1_P2_Captured		%DB40.DBX543.2			Bool
"DB40".	W1_Accepted		%DB40.DBX543.3			Bool
"DB40".	Solenoid_Forced		%DB40.DBX543.4			Bool
"DB40".	Sol_1		%DB40.DBX544.0			Bool
"DB40".	Bar_Mode		%DB40.DBX544.1			Bool
"DB40".	PSI_Mode		%DB40.DBX544.2			Bool
"DB40".	AIW04_Cal_Enabled		%DB40.DBX544.3			Bool
"DB40".	AIW04_Cal_Accepted_Vis		%DB40.DBX544.4			Bool
"DB40".	AIW06_Cal_Enabled		%DB40.DBX544.5			Bool
"DB40".	AIW06_Cal_Accepted_Vis		%DB40.DBX544.6			Bool
"DB40".	AIW08_Cal_Enabled		%DB40.DBX544.7			Bool
"DB40".	AIW08_Cal_Accepted_Vis		%DB40.DBX545.0			Bool
"DB40".	AIW12_Cal_Enabled		%DB40.DBX545.1			Bool
"DB40".	AIW12_Cal_Accepted_Vis		%DB40.DBX545.2			Bool
"DB40".	AIW14_Cal_Enabled		%DB40.DBX545.3			Bool
"DB40".	AIW14_Cal_Accepted_Vis		%DB40.DBX545.4			Bool
"DB40".	AIW16_Cal_Enabled		%DB40.DBX545.5			Bool
"DB40".	AIW16_Cal_Accepted_Vis		%DB40.DBX545.6			Bool
"DB40".	AIW18_Cal_Enabled		%DB40.DBX545.7			Bool
"DB40".	AIW18_Cal_Accepted_Vis		%DB40.DBX546.0			Bool
"DB40".	DL_P2_P1_EU		%DB40.DBD548	P2 First Point Cal Engineering Units	bar/PSI	Real
"DB40".	DL_P2_P2_EU		%DB40.DBD552	P2 Second Point Cal Engineering Units	bar/PSI	Real
"DB40".	DL_PRV1_P1_EU		%DB40.DBD556	PRV1 First Point Cal Engineering Units	bar/PSI	Real
"DB40".	DL_PRV1_P2_EU		%DB40.DBD560	PRV1 Second Point Cal Engineering Units	bar/PSI	Real
"DB40".	DL_PRV2_P1_EU		%DB40.DBD564	PRV2 First Point Cal Engineering Units	bar/PSI	Real
"DB40".	DL_P3_P1_EU		%DB40.DBD572	P3 First Point Cal Engineering Units	bar/PSI	Real
"DB40".	DL_P3_P2_EU		%DB40.DBD576	P3 Second Point Cal Engineering Units	bar/PSI	Real
"DB40".	DL_P4_P1_EU		%DB40.DBD580	P4 First Point Cal Engineering Units	bar/PSI	Real
"DB40".	DL_P4_P2_EU		%DB40.DBD584	P4 Second Point Cal Engineering Units	bar/PSI	Real
"DB40".	DL_P5_P1_EU		%DB40.DBD588	P5 First Point Cal Engineering Units	bar/PSI	Real

Structure	Tagname plc in DB40 Tagname in structure	PLC Address	Definition	Units	Data Type
"DB40".	DL_P5_P2_EU	%DB40.DBD592	P5 Second Point Cal Engineering Units	bar/PSI	Real
"DB40".	DL_W1_P1_EU	%DB40.DBD596	W1 First Point Cal Engineering Units	Kg	Real
"DB40".	DL_W1_P2_EU	%DB40.DBD600	W1 Second Point Cal Engineering Units	Kg	Real

17. Appendix 8: Audit trail (If equipped)

Note: Audit trail functionality is available on systems with HMI software version 4.36 or higher.

The XCell™ C410:V4B Controller can be equipped with software that will enable audit trail recording of HMI inputs. The audit trail will not record inputs from a supervisory control system and is intended primarily for end-users who intend to use the XCell ATF® Device in a standalone fashion. This functionality can be enabled by purchasing the add-on C410-V4B-AT for a nominal fee alongside the purchase of a XCell™ C410:V4B Controller. The audit trail file will be recorded on an SD card included in the HMI. This file has a maximum allowable size of 64 MB. If this file reaches its maximum capacity, an alarm will display on the HMI indicating that the maximum size has been reached and that audit trail recording will no longer be saved unless space is freed up. Changes to the following inputs are recorded in the audit trail:

Description	Name
Command Word – XCell ATF® Start	ATF_START
Command Word – XCell ATF® Stop	ATF_STOP
Command Word - Acknowledge Alarms	AFT_Ack_Alarms
Command Word - XCell ATF® - Control Mode (Flow/Time)	ATF_Control_Mode
Command Word - XCell ATF® - Slope Enable	ATF_Slope_Enabled
Connected Bioreactor (INT number)	ATF_ConnectedBR
Pressure Flow Setpoint LPM	PFLOWSP
Pressure Flow Setpoint SEC	PTIMESP
Exhaust Flow Setpoint LPM	EFLOWSP
Exhaust Flow Setpoint SEC	ETIMESP
Flow Regulator Setpoint (bar)	PRV1
Exhaust Regulator Setpoint (bar)	PRV2
Flow Prop Valve Setpoint (%)	PV1
Exhaust Prop Valve Setpoint (%)	PV2
Batch name, 5 Char (bytes)	BatchName[0]
	BatchName[1]
	BatchName[2]
	BatchName[3]
	BatchName[4]
Bioreactor Backpressure	Bioreactor_Backpressure
Height Differential SP	Height_Differential
Flow Driving Force Offset for switching	FDFOFST
Pressure Cycle Delay Time SP	Press_Cycle_Delay_Time_SP
Pressure Cycle Over Time SP	Press_Cycle_Over_Time_SP
Pressure Cycle - PV Step Size - %	Pres_Cycl_PV_Step_Size
Exhaust Driving Force Offset for switching	EDFOFST
Vacuum Cycle Delay Time SP	Vac_Cycle_Delay_Time_SP
Vacuum Cycle Over Time SP	Vac_Cycle_Over_Time_SP
Exhaust Cycle PV Step Size %	Exhs_Cycl_PV_Step_Size
P2 Alarm Limit Hi Set Point	P2_Pressure_Alarm_Hi_Hi_SP
P2 Pressure Alarm Hi Timer SP	P2_Alarm_Hi_Hi_TMR_SP
P2 Alarm Limit Lo Set Point	P2_Pressure_Alarm_Lo_Lo_SP
P2 Pressure Alarm Lo - Timer SP	P2_Alarm_Lo_Lo_TMR_SP
Max Pressure Flow Setpoint LPM	PFLOWMAXSP
Min Pressure Flow Setpoint LPM	PFLOWMINSP
Max Exhaust Flow Setpoint LPM	EFLOWMAXSP
Min Exhaust Flow Setpoint LPM	EFLOWMINSP

Description	Name
Max Pressure Flow Setpoint SEC	PTIMEMAXSP
Min Pressure Flow Setpoint SEC	PTIMEMINSP
Max Exhaust Flow Setpoint SEC	ETIMEMAXSP
Min Exhaust Flow Setpoint SEC	ETIMEMINSP
Flow Prop Valve Max Value (%)	PV1MAX
Flow Prop Valve Min Value (%)	PV1MIN
Exhaust Prop Valve Max Value (%)	PV2MAX
Exhaust Prop Valve Min Value (%)	PV2MIN
Flow Regulator Max Value (bar)	PRV1MAX
Flow Regulator Min Value (bar)	PRV1MIN
Exhaust Regulator Max Value (bar)	PRV2MAX
Exhaust Regulator Min Value (bar)	PRV2MIN
Calibration Word	
	P2_Cal_Enable
	PRV1_Cal_Enable
	PRV2_Cal_Enable
	P3_Cal_Enable
	P4_Cal_Enable
	P5_Cal_Enable
	W1_Cal_Enable
	P2_Accept
	PRV1_Accept
	PRV2_Accept
	P3_Accept
	P4_Accept
	P5_Accept
	W1_Accept
	Force_Solenoid
	PV1_SP
	PV2_SP
	PRV1_SP
	PRV2_SP
Calibration - AIW04 - Point 1 - Engineering Value	P2_P1_EU
Calibration - AIW04 - Point 2 - Engineering Value	P2_P2_EU
Calibration - AIW06 - Point 1 - Engineering Value	PRV1_P1_EU
Calibration - AIW06 - Point 2 - Engineering Value	PRV1_P2_EU
Calibration - AIW08 - Point 1 - Engineering Value	PRV2_P1_EU
Calibration - AIW08 - Point 2 - Engineering Value	PRV2_P2_EU
Calibration - AIW12 - Point 1 - Engineering Value	P3_P1_EU
Calibration - AIW12 - Point 2 - Engineering Value	P3_P2_EU
Calibration - AIW14 - Point 1 - Engineering Value	P4_P1_EU
Calibration - AIW14 - Point 2 - Engineering Value	P4_P2_EU
Calibration - AIW16 - Point 1 - Engineering Value	P5_P1_EU
Calibration - AIW16 - Point 2 - Engineering Value	P5_P2_EU
Calibration - AIW18 - Point 1 - Engineering Value	W1_P1_EU
Calibration - AIW18 - Point 2 - Engineering Value	W1_P2_EU

The audit trail file is recorded on the SD card in the form of a .csv file. This file can be viewed in Siemens Audit Viewer and includes a validity check to show in Audit Viewer that the file has not been opened. Opening this file in Excel will null the validity check. For each change entered by a user via the HMI, the audit trail will record:

- Parameter changed

- Sequential number of the change
- Time of the change
- User responsible for the change
- Original value of the parameter
- New value of the parameter

This information is shown in Audit Viewer in the screenshot below. The data validity indicator can be seen on the left panel of the Audit Viewer.

Figure 25. Audit Viewer

RecordID	TimeStamp	DeltaToUTC	UserID	ObjectID	Description	Comment
0	01.01.2016 20:40:31	+0:00	System	Application	Runtime start of WinCC Runtime: Advanced V13.00 - SP01 HF9 on ...	
49	01.01.2016 20:40:31	+0:00	System	User administration	User administration imported successfully.	
50	01.01.2016 20:40:31	+0:00	System	Application	Change to operating mode 'online'.	
51	01.01.2016 21:19:59	+0:00	System	User administration	User 'Admin' logged on with group 'Administrators'.	
52	01.01.2016 21:20:40	+0:00	Admin	Tag: START_BIT	Change of the tag value 'START_BIT' from '0' to '-1' by entering '1'.	
53	01.01.2016 21:20:45	+0:00	Admin	Tag: START_BIT	Change of the tag value 'START_BIT' from '0' to '-1' by entering '1'.	
54	01.01.2016 21:21:42	+0:00	Admin	Tag: AIW04_Cal_Select	Change of the tag value 'AIW04_Cal_Select' from '0' to '-1'.	
55	01.01.2016 21:21:42	+0:00	Admin	Tag: AIW04_Cal_Select	Change of the tag value 'AIW04_Cal_Select' from '0' to '-1'.	
56	01.01.2016 21:22:04	+0:00	Admin	Tag: AIW04_Cal_P_1_EU	Change of the tag value 'AIW04_Cal_P_1_EU' from '2.1' to '2.5'.	
57	01.01.2016 21:22:49	+0:00	Admin	Tag: AIW04_Cal_Accept	Change of the tag value 'AIW04_Cal_Accept' from '0' to '-1'.	

18. Appendix 9: General Information and Handling Instructions

1. Repligen XCell ATF® System is rated for acceptable sound levels (60 dBA).
2. Weight of XCell™ C410:V4B Controller: Electronic Box 23 kg (50 lbs), Pneumatic Enclosure 13 kg (28.6 lbs).
3. Complete system visual inspection for damage or potential risk to the operator, surrounding personal, or equipment on a semi-annual basis.
4. Annual safety Inspection.
 - Conduct a vacuum system leak assessment
 - Replace the air filter between the XCell ATF® Device and the XCell™ C410:V4B Controller
 - Inspect air and vacuum connections to the controller
 - Inspect that all components inside of the controller are secured and intact
 - Inspect enclosure for damage, locks and hinges for performance,
 - Inspect the XCell ATF® Device housing components, especially the internal and sealing surfaces for damage, rust, cracks, scoring
 - Perform a pressure hold test of the XCell ATF® Device

Handling Instructions



TRANSPORTATION: The XCell™ C410:V4B Controller Electronics Enclosure weighs 23 kg (50 lbs) and the Pneumatic Enclosure weighs 13 kg (29 lbs). Care should be taken when lifting and transporting and use of a cart is recommended.



NOTE: The XCell™ C410:V3 Controller and XCell ATF® 4 Device, XCell ATF® 6 Device, and XCell ATF® 10 Device have been assessed for CE regulations under the current applicable Machinery Directives such as Essential Health and Safety Requirements, the Low Voltage Directive, and the Electromagnetic Compatibility Directive and the Pressure Equipment Directives. Please refer to the Declaration of Conformity letter included with the equipment.



VOLTAGE: Hazardous voltage inside, disconnect power before opening. Device must stay connected to the power cord to function as intended. This product must not be used with a detachable power cord that is not provided by Repligen.



SERVICE: All cords/ wires must be grounded properly per product safety requirements of CE mark.

19. Appendix 10: Spare parts list

Table 35. Spare parts

XCell ATF® Electronics Spares	
C410:EP-AD-CB-NC	Pushbutton, 22 mm metal latch with twist-to-release LED illuminated red, 24 VAC/DC, 40 mm mushroom operator 1 N.C. contact block
C410:E-AD-CB-NO-1252	Selector switch, 22 mm metal 2-position, maintained LED illuminated 24VAC/DC knob operator 1 n.o. contact block
C410:E-AX-MCB	Miniature circuit-breakers - 10 Amp - 2 Pole - characteristic curve B
C410:E-NI-ECF	BUSSMANN - BK/MDL-5-R - electronic cartridge fuse
C2410V3:E-AX-CPU	CPU, SIMATIC S7-1200, 1214C, DC / DC / DC
C410V3:AX-TS	Siemens Simatic HMI TP1200 comfort panel
C410:E-Simatic-I	Module, Simatic s7-1200 analog input, SM1231
C410:E-Simatic-O	Module, Simatic S7-1200 analog output SM1232
C410:E-GC-RP	24VDC relay 1 pole
C410:E-NI-LF	RFI line filter
C410:E-AX-24PS	24VDC Power supply enclosure @ 10 AMPS – TRIO-PS/1AC/24DC/10
C410:E-PR-IA	Standard signal 3-way isolating amplifiers, not configurable. MINI MCR-SL-I-I
XCell ATF® Device:CHIP-C410v4B-HMI	Chip, disaster recovery, HMI, C410v4B
XCell ATF® Device:CHIP-C410v4B-PLC	Chip, disaster recovery, PLC, C410v4B
C2410:P-AX-RD1	SIEMENS S7-200 BATTERY CARTRIDGE
C410:E-PB-MOD	Profibus module for S7-1200
C2410:E-AX-CPU	SIMATIC S7-200 CPU module
XCell ATF® 6 Device Pneumatics Spares	
C410:P6-RF-PM	Pressure manifold for C410:6
C410:P6-RF-EM	Exhaust manifold for C410:6
C410v2:P48-RF-SOL1	ASSEMBLY, 3-way valve - SOL1 for C410 v1 and v2 XCell ATF® 4 Device, XCell ATF® 6 Device
C410:P-KN-PR-0-60	REGULATOR 0-60PSI
C410:P-1.5VG	1.5" vacuum gauge 0-30"Hg CENTER BACK 1/8" NPT,7216-1½-1/8 30/0 FLANGE MOUNT-replaces C410:P-MF-PG-0-30FM
C410:P-1.5PG	1.5" PRESSURE GAGE 0-60PSI CENTER BACK 1/8" NPT, 7216-1½-1/8 0-60 FLANGE MOUNT-replaces C410:P-MF-PG-0-60FM
XCell® ATF46-PRV	Pressure release valve; XCell ATF® 4 Device or XCell ATF® 6 Device
XCell ATF® 10 Device Pneumatics Spares	
C410V2:P10-RF-PM	Pressure Manifold sub-assembly for C410v2 Controller for XCell ATF® 10 Device
C410V2:P10-RF-EM	Exhaust Manifold sub-assembly for C410-v2 controller for XCell ATF® 10 Device, with P2 and SOL1
C410V2:P10-RF-SOL1	ASSEMBLY, 3-way valve - SOL1 for C410v2 XCell™ 10 Controllers
C410:P-KN-PR-0-60	REGULATOR 0-60PSI
C410:P-1.5VG	1.5" Vacuum gauge 0-30"Hg CENTER BACK 1/8" NPT,7216-1½-1/8 30/0 FLANGE MOUNT-replaces C410:P-MF-PG-0-30FM
C410:P-1.5PG	1.5" PRESSURE GAGE 0-60PSI CENTER BACK 1/8" NPT, 7216-1½-1/8 0-60 FLANGE MOUNT-replaces C410:P-MF-PG-0-60FM
C410-P-KN-PR-40-420-P10	PRV assembly replacement part
C410V2:P10-RF-PV	PV1 valve with matching amplifier board for a C410V2:10 pneumatics
XCell ATF® 10 Device-PRV	Pressure release valve; XCell ATF® 10 Device

XCell ATF® Housing Spares	
XCell ATF® 6 Pump Housing Spares	
A6-H1	Filter housing assembly, XCell ATF® 6 Device
A6:R1	Reducer, XCell ATF® 6 Device
XCell ATF® 6 Device: PHLA	Pump Hemisphere, Liquid Side Assembly, XCell ATF® 6 Device
A6-BASE	Pump hemisphere, base plate, assembly, XCell ATF® 6 Device
SG-05-E	Sanitary gasket, 1/2" TC
SG-075-E	Sanitary gasket, 3/4" TC
SG-1.5-E	Sanitary gasket, 1 1/2" TC
O:337-S-GMP	Silicone size 337 70A O-ring
TC:PG:3/4	Pressure gauge, 3/4 TC 30PSI to - 30" Hg
TC-EL1S	Elbow 90 degree -1.0, TC ends
SG-1.0-E	Sanitary gasket 1" TC
TC:W2-1.5	Window, sanitary 1.5"TC, w/Rem. glass insert
TC-CAP-3/4	Sanitary cap 3/4"
V1-S-0.5N	Sanitary diaphragm valve, 1/2" w/TC ends
SC-075	Clamp, sanitary, 1/2"-3/4" TC
SC-1.5	Clamp, sanitary, 1 1/2" TC
A6-BASE-SHCS	1/4-20x3/8 socket head cap screw (4)
SC-3L	Clamp, sanitary, 3.0" TC
SC-6.0	Clamp, sanitary 6.0" TC
TC-BRB1	Sanitary adapter, 3/4" tri-clamp x 1/4" hose barb fitting
XCell ATF® 6 Device: AIR-ASSY	Air inlet assembly, XCell ATF® 6 Device
P3-CPM1.5-TC3/4	Kit, PT, 1.5"CPM fitting, 3/4"TC
XCell ATF® 6 Device PH-AA-AIR	Air hemisphere, XCell ATF® 6 Device w/ XCell ATF® 6 Device: AIR-ASSY
XCell ATF® 10 Pump housing spares	
A10-STAND	Stand, Assembly, XCell ATF® 10 Device
A10RF-C3	ASME clamp, assembly, XCell ATF® 10 Device
A10RF-H1	Filter housing assembly, XCell ATF® 10 Device
A10RF:HA	Lifting handle, assembly, XCell ATF® 10 Device
XCell ATF® 10:PHLA	Pump hemisphere liquid side, Assembly, XCell® ATF 10 Device
A10-R1	Reducer, XCell ATF® 10 Device
A10RF-C3-RELIEF	ASME clamp w/ relief, assembly, XCell ATF® 10 Device
A10:C1-LOCK-A	C clamp w/ Lock-A, assembly, XCell ATF® 10 Device
A10:C1-LOCK-B	C clamp w/ Lock-B, assembly, XCell ATF® 10 Device
SG-05-E	Sanitary gasket, 1/2" TC
SG-075-E	Sanitary gasket, 3/4" TC
SG-1.5-E	Sanitary gasket, 1 1/2" TC
TC-W2-1.5	Window, sanitary 1.5" TC, with / Rem. glass insert 316 L SS/Glass
TC-CAP-3/4	Sanitary cap 3/4"
TC-EL-1.5S	90 Degree ell, 1.5TC
TC-PG-1.5	Pressure gauge, 1.5 TC, 30 psi

XCell ATF® Electronics Spares	
V1-S-0.5N	Sanitary diaphragm valve, 1/2" w/TC ends
SC-075	Clamp, sanitary 1/2-3/4" TC
SC-1.5	Clamp, sanitary, 1 1/2" TC
O-CTM-10H	O-ring, 50 Duro, Clear, 0.295" C/S x 6.835" ID x 7.425" OD
O:349-S-GMP	O:349-S-GMP, "O:349-S-GMP; O-ring for XCell ATF® 10 Device, USP Class VI, package of 2"
XCell ATF® 10:NUT-HVY- 1/2"-13	XCell ATF® Device 10 ASME Monel heavy hex nut 1/2"-13
XCell ATF® 10:NUT-FIN- 1/2"-13	XCell ATF® 10 Device ASME Monel fine hex nut 1/2" -13
A:ST-TS	A:ST-TS, thumb screw for XCell ATF® 10 XCell Device base
XCell ATF® 10:AIR-ASSY	Air inlet assembly, XCell ATF® 10 Device
XCell ATF® 10:PH-AA-AIR	Air hemisphere, XCell ATF® 10 Device w/ XCell ATF® 10 Device :AIR-ASSY
P3-CPM1.5-TC3/4	Kit, PT, 1.5"CPM fitting, 3/4"TC

20. Appendix A: Audit trail and domain user control customizations for the XCell™ ATF Control System C410-V4B-GMP

20.1 Purpose

The purpose of this section is to provide information about the customization of the XCell™ ATF (Alternating Tangential Flo) Control System per CC18034. This document will include background on the additional software, as well as information about additional requirements of the system for successful implementation and small details that may not be easily identified.

20.2 System description

The XCell™ ATF C410V4B Controller is sold by Repligen as a perfusion device to be used with the XCell ATF® pump housings sizes 4 - 10. The system consists of three separate enclosures: a controls enclosure, electric enclosure, and a pneumatic enclosure. The controller operates by utilizing two separate manifolds consisting of proportional and pressure regulation valves connected to a solenoid to switch between pressure and vacuum cycles. This operation inflates and deflates a silicone diaphragm of a known size at a consistent rate to flow retentate through a hollow fiber module. The three enclosures consist of the following components.

- **Controls enclosure:** This enclosure contains the Siemens CPU 1214C DC/DC/DC, SM 1231 AI, Siemens Communication Module CM 1242-5, SM1232 AQ PLC modules, and the Siemens TP1200 Comfort Touch Screen HMI. The function of this box is to control the pneumatic manifolds in the pneumatic enclosure through a control algorithm based on feedback from the P2 pressure transducer.
- **Electric enclosure:** Contained within this enclosure are all components above 50 volts. The function of this enclosure is to separate all high voltage components so the controls and pneumatics enclosures can be opened without exposing personnel to electric shock hazards.
- **Pneumatic enclosure:** This enclosure houses the two manifold assemblies connected to the solenoid which control the vacuum and exhaust flow rates into the diaphragm. These manifolds differ with the size of the XCell ATF® Filter housing the controller supports and the valves are controlled by signals from the controls enclosure.

This system also includes an integrated HMI for operators to control the system. At the completion of CC18034, this HMI will include an optional audit trail and Windows user administration for customers to request during purchase in addition to all of the original functionality.

20.3 References

The following documents support the generation and execution of this document:

- XCell ATF® System with C410V4B Controller User Guide
- Siemens Logging Process Values and Alarms – WinCC (TIA Portal)/V14/HMI Operator Panels document
- Siemens Simatic WinCC (TIA Portal) V13 Guidelines for Implementing Automation Projects in a GMP Environment
- Siemens Simatic - Simatic Logon Configuration Manual

20.4 Software background

Below describes each software addition that will be used for implementing Windows User Administration and an audit trail. Information includes detailed information that will assist in implementation.

20.5 TIA Portal



TIA Portal is the application used to create and download programs to the XCell™ ATF Controller. TIA Portal was used to program both the PLC and the HMI. Two Siemens licenses are required to use TIA Portal, one for the PLC and one for the HMI. The license version must be 16 or greater. The licenses are managed in the license manager.

1. TIA Portal opens in a Portal View. Click the Project view button in the lower left.

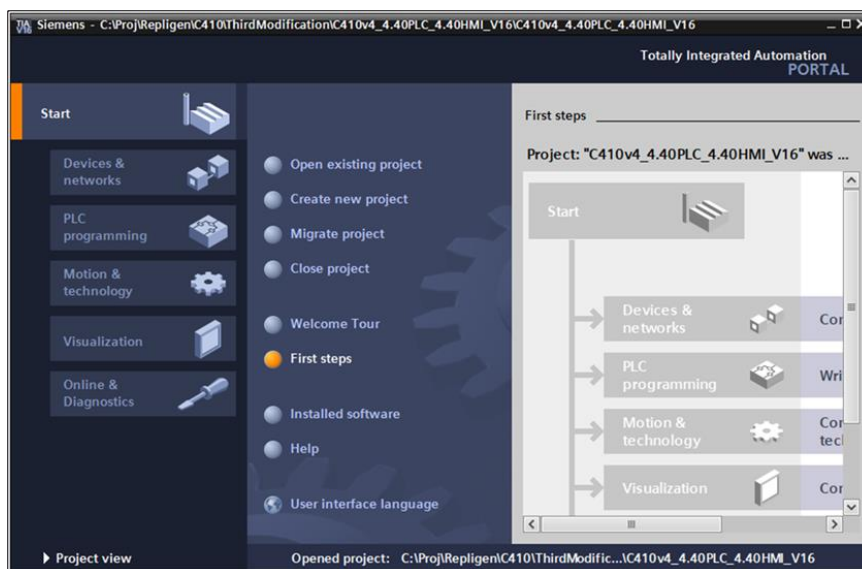

2. In the project view, select Project > Open... from the top left,

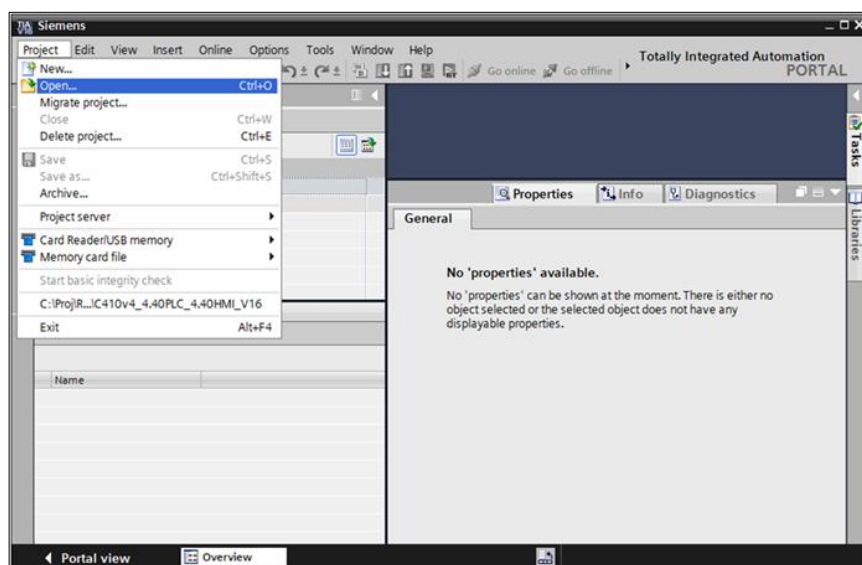

- The first time, select Browse and open the Repligen provided .zap16 archive file. Afterwards, the project will be in the Recently used area and can just be selected. Then press Open.

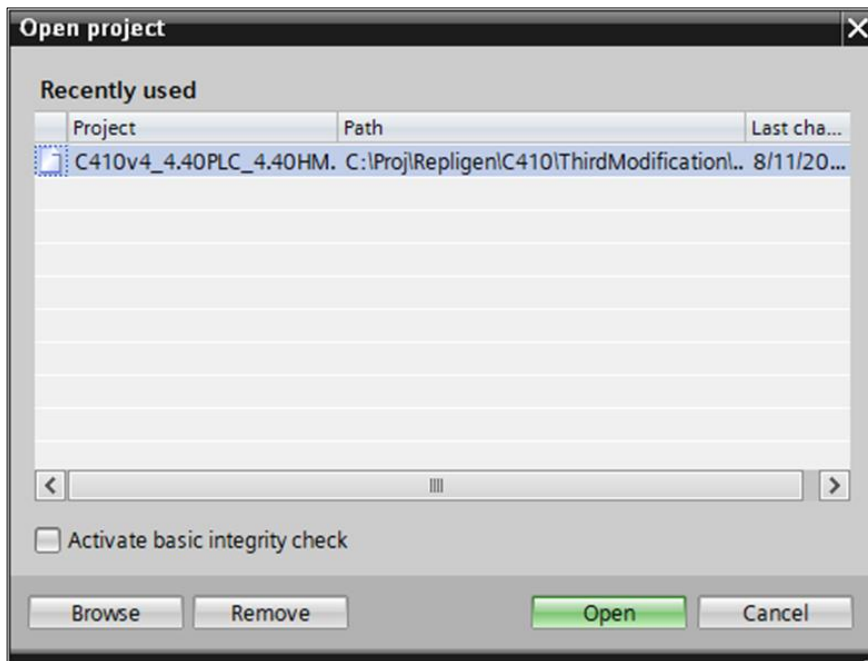

- To connect the XCell™ ATF Controller, connect an ethernet cable between your computer and the controller's ethernet port. Then right click on the project and select Go Online:

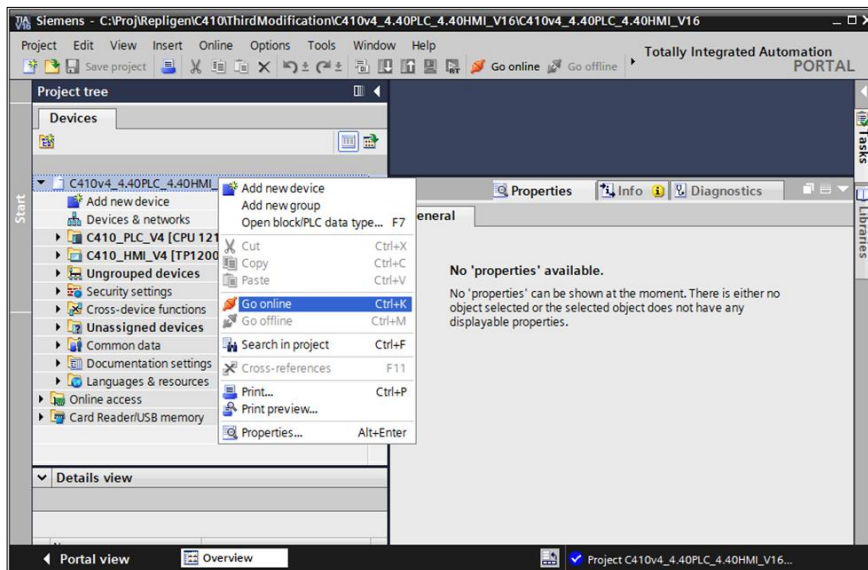

5. Select the device you want to connect to (the PLC or HMI):

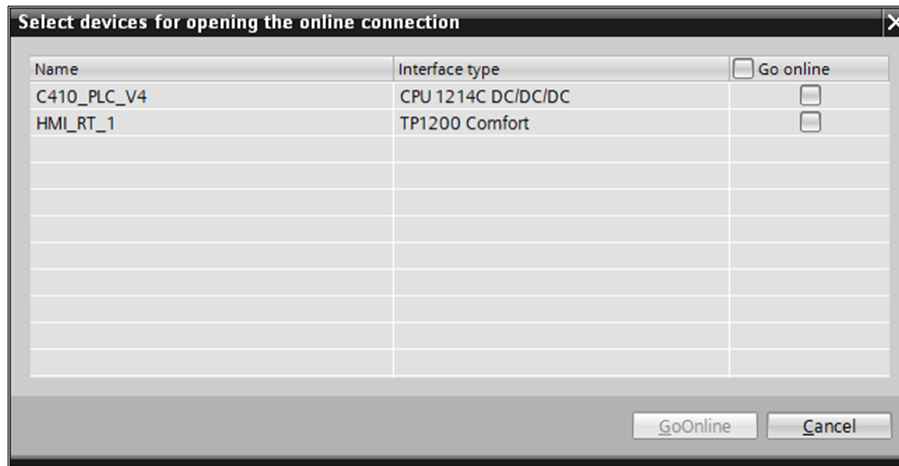

6. Select your computer's ethernet port in the drop down selections and click Start Search. Then click GoOnline.

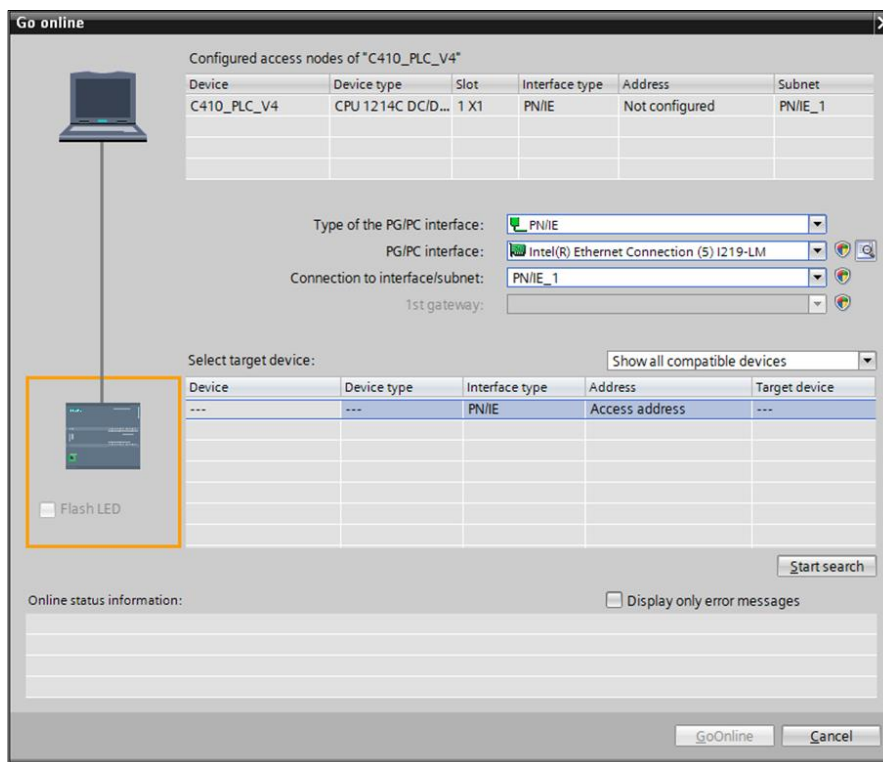

20.6 Users, User Groups and authorizations

Security is already built into WinCC, and works based on three categories:

1. Users: Each user must be assigned to exactly one group.
2. Groups: Each group can be assigned any number of authorizations.
3. Authorizations: Each graphical object can be assigned up to one authorization.

For example, a user Bob is a member of the group Operator. The group Operator has the authorization Monitor. The Monitor authorization is required for the basic navigation buttons on the HMI. A user Mary is a member of the group Engineer which has a few authorizations, including Monitor and Setup. The Setup authorization is required to change setup parameters. Therefore, Mary can navigate to screens and set up the system.

Users and Groups can be configured in TIA Portal or SIMATIC Logon. SIMATIC Logon allows for a common user database, allowing for Windows User administration. When using SIMATIC Logon,

20.7 SIMATIC Logon

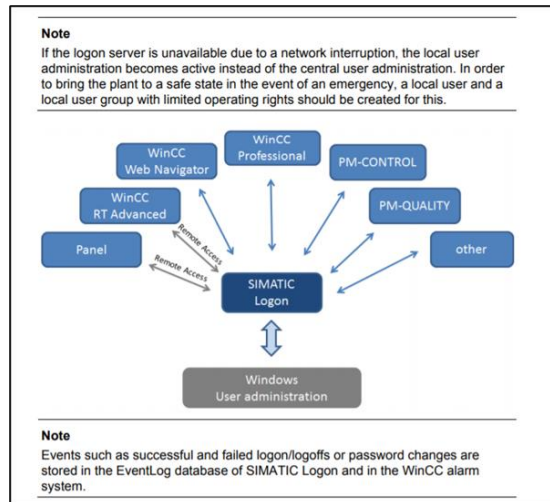

The SIMATIC Logon features of the WinCC Comfort panels and software must be enabled by a SIMATIC Logon license and a SIMATIC Logon Remote Access license. The SIMATIC Logon license allows the Windows user domain to be accessed by the Siemens software. This license is installed on a computer with the user domain active on it. All users who require access must be in the domain that the Logon license is connected to because this software cannot read subdomains even if the subdomain is within the main domain. The Remote Access license is installed on the panel and allows the panel to read the users from the Logon license. The comfort panels cannot access the user directory directly. The handshake between these two licenses can be seen in the graphic above.

With these licenses there is the opportunity to use electronic signatures to confirm changes. Section 5.7 of the SIMATIC Logon Configuration guide has more details about the electronic signature feature. The number of logon attempts can also be limited to prevent users without access to the system gaining access by guessing the correct combination of username and password.

Before the user domain can be used to access the system there is some initial configuration within SIMATIC Logon for the logon routine that must be completed.

1. Create a new Windows user group Logon_Administrator.
2. Add the users who will be configuring SIMATIC Logon to the group.
3. Configure SIMATIC Logon as detailed in [Section 20.7](#). More details about the settings can be found in the SIMATIC Logon manual. A summary is provided below:

The "Configure SIMATIC Logon" dialog box has the following tabs:

Tab	Settings
General (Page 25)	<ul style="list-style-type: none"> • Selection of the display language • Activation of the time display according to ISO 8601 • Disabling/enabling the "Default user" function • Setting the reminder of the password expiration (information x days before password expires)
Working environment (Page 27)	Setting the computer from which user data will be obtained: <ul style="list-style-type: none"> • From the computer being used or from a "Windows domain" • From another computer (enter the name of the computer)
Logon device (Page 29)	Setting the device on which the logon for a component will be checked: <ul style="list-style-type: none"> • Keyboard • Smart card reader • Other devices
Automatic logoff (Page 30)	Setting the delay time before logging off from SIMATIC Logon.

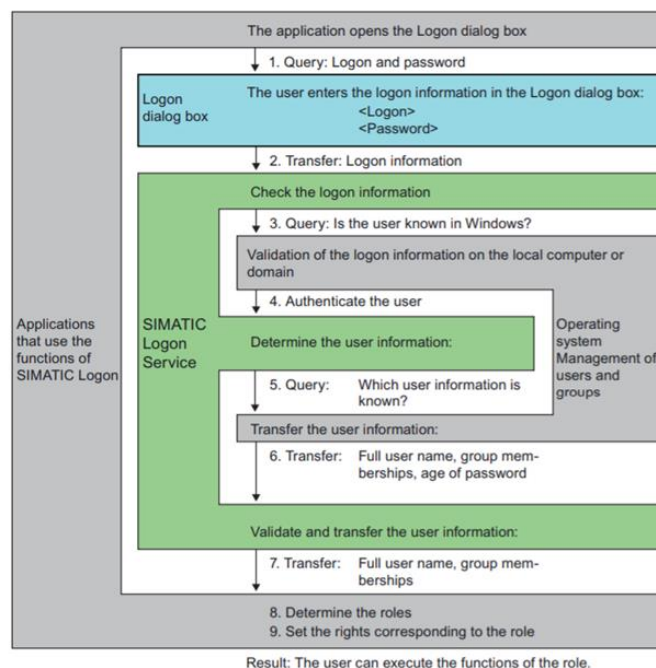
Figure 26. How SIMATIC Logon interacts with the HMI

20.8 Audit trail

The audit trail functionality is already built into WinCC. However, to access it without warnings an audit trail license is required. The configuration of audit trail tracked tags only requires two check boxes. More details on how to configure the software to include an audit trail can be found in [Section 20.11](#) of this document.

When the audit trail is running it will save the data to a location that is determined during the initial configuration. This location can be a USB, an SD card, or a network location. There is no specific hardware required for this functionality to be available.

The audit trail can also be used to generate a batch report. This functionality must be scripted and can be called on a button press on the HMI, on an event, or after a set period of time. The batch report layout is editable by an application in the TIA portal, which allows the end user to create a report that fits their specifications.

20.9 Implementation

The following sections provide a step by step guide to customize users, security, connect to Windows user administration, generate an audit trail and synchronize with a Network Time Protocol (NTP) server.

20.10 TIA Portal: Creating additional users and user groups

1. Repligen has pre-created three users and three user groups.
 - a. Oper1 a member of the Operator group.
 - b. Eng1 a member of the Engineer group.
 - c. Admin a member of the Administrator group.

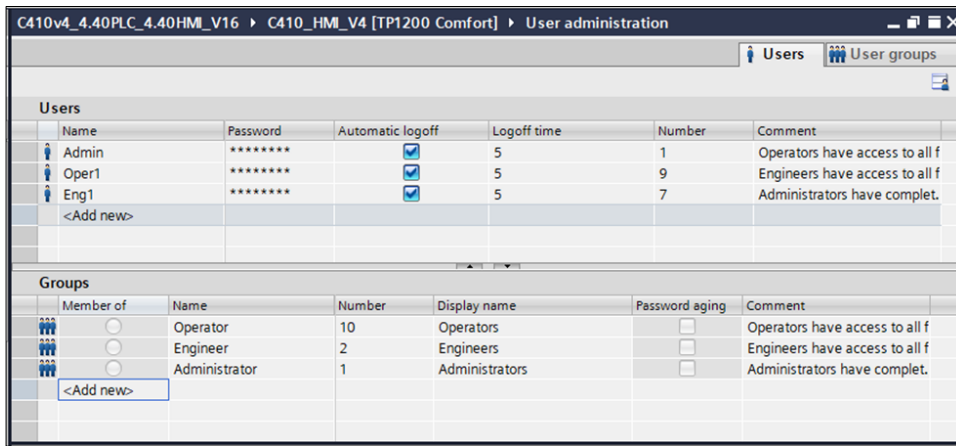

2. To create a new user group within TIA portal, under Groups select <Add new>, and enter a group name and display name.
3. To create a new user within TIA portal, under Users select <Add new>, enter a username, password and logoff time, and specify what group the user is a member of.

Note: Each user must be a member of exactly one user group.

20.11 TIA Portal: Authorizations and object level security

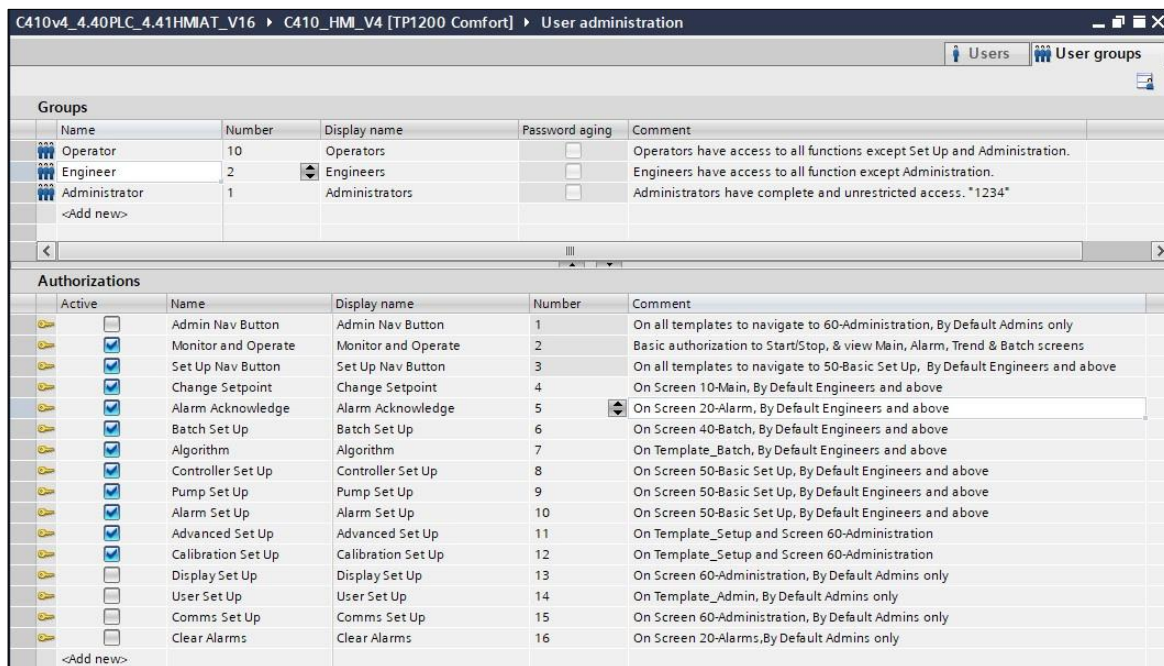

1. Repligen has pre-created 15 Authorizations. Each user group can be assigned any number of authorizations.
2. Secured objects are assigned an authorization. The following figures demonstrate how the existing authorizations are set up by screen.

1. Alarm Screen:
 - A. Alarm acknowledge authorization

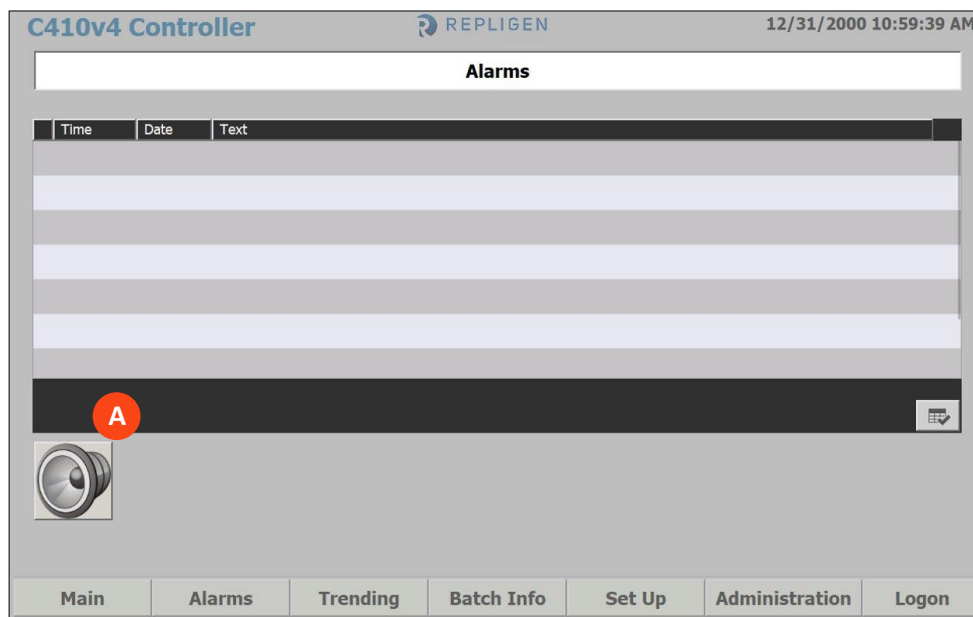

2. Batch Screen:
 - B. Batch Set Up authorization
 - C. Algorithm authorization

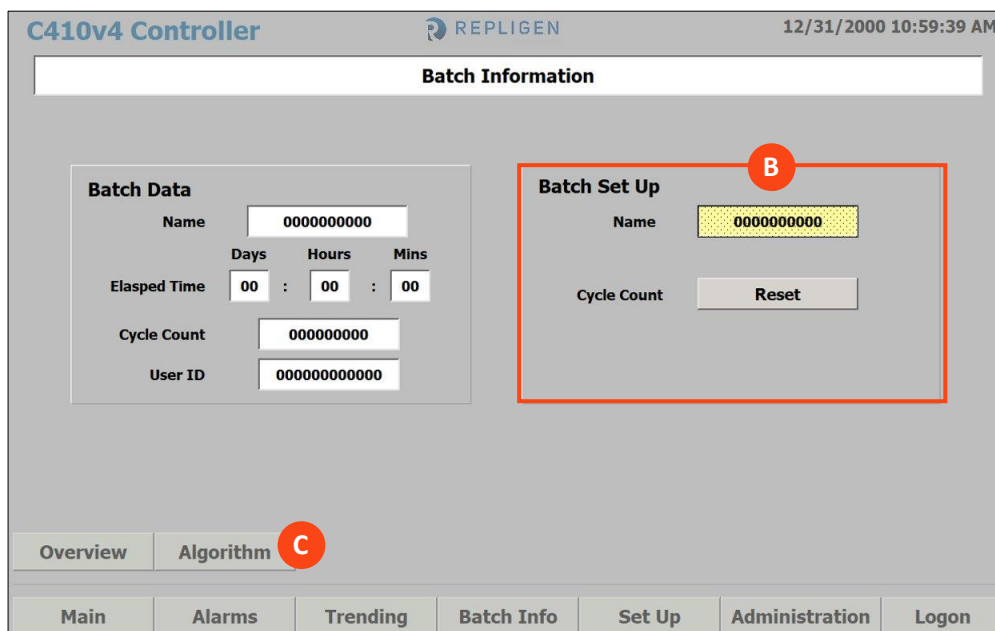

3. Basic Set Up Screen:
 - D. Controller Set Up authorization
 - E. Pump Set Up authorization
 - F. Alarm Set Up authorization
 - G. Advanced Set Up authorization
 - H. Calibration authorization

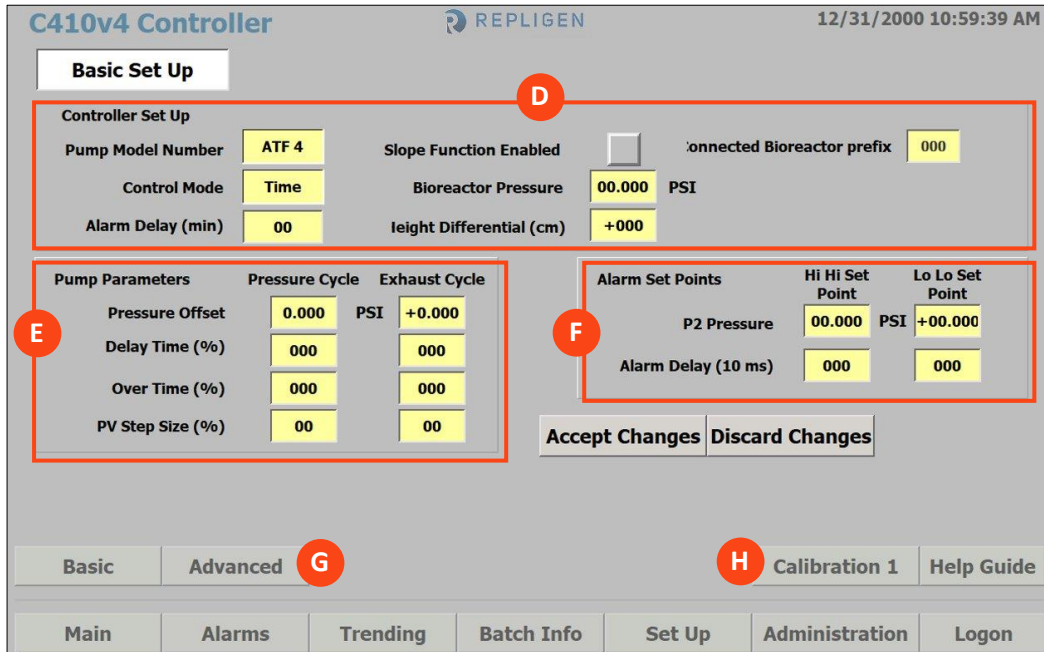

4. Administration Screen:
 - I. Display Set Up authorization
 - J. Advanced Set Up authorization
 - K. Comms Set Up authorization
 - L. Change Mode
 - M. Display Set Up authorization
 - N. User Set Up authorization
 - O. Calibration
 - P. Close application

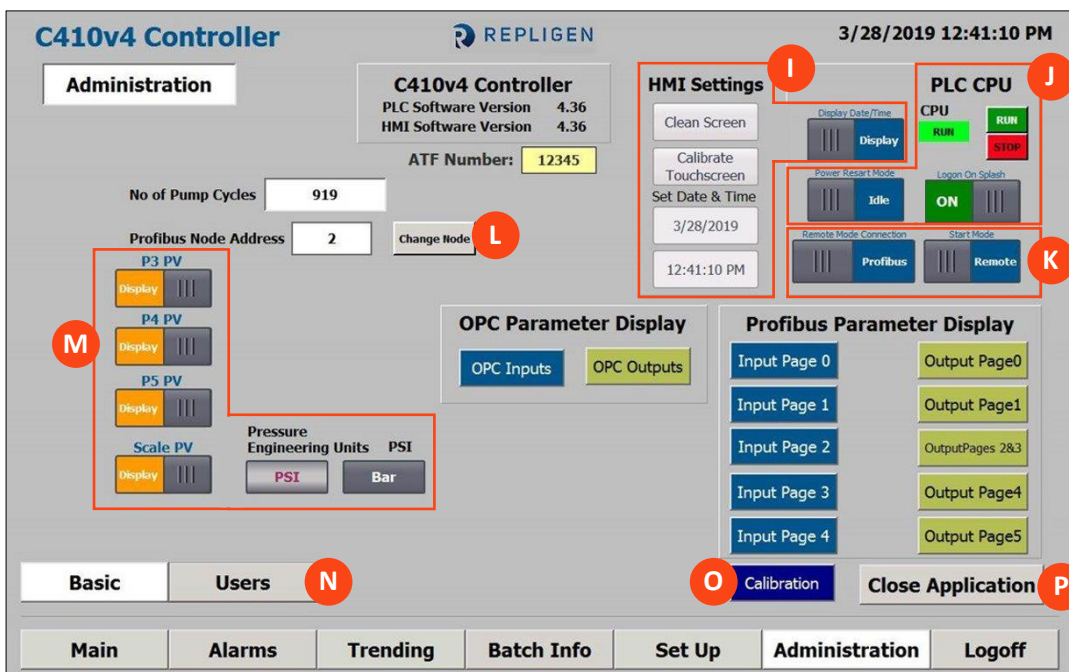

- To change an object’s authorization, select the object and access the Security menu. Under Runtime Security, select an Authorization from the drop-down menu.

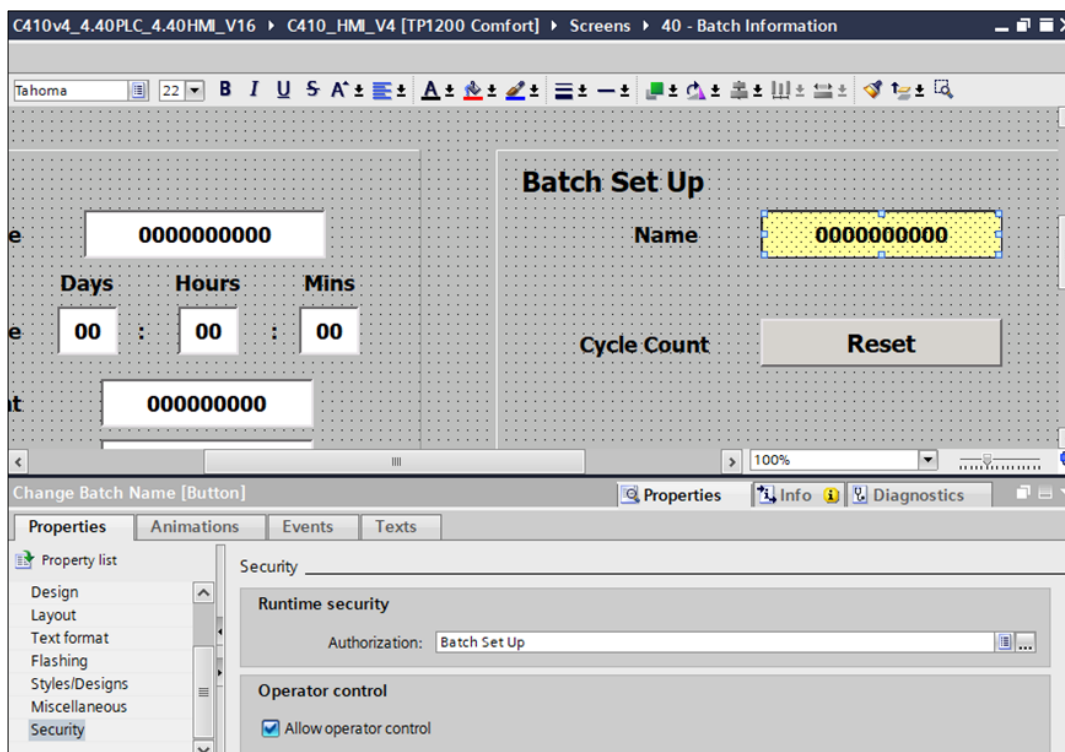

20.12 SIMATIC Logon

Note: At this time Windows 10 blocks required components of SIMATIC Logon and is not supported. Use Windows 7 or a Windows server operating system.

- On the host computer/server, open Computer Management > Local Users and Groups.

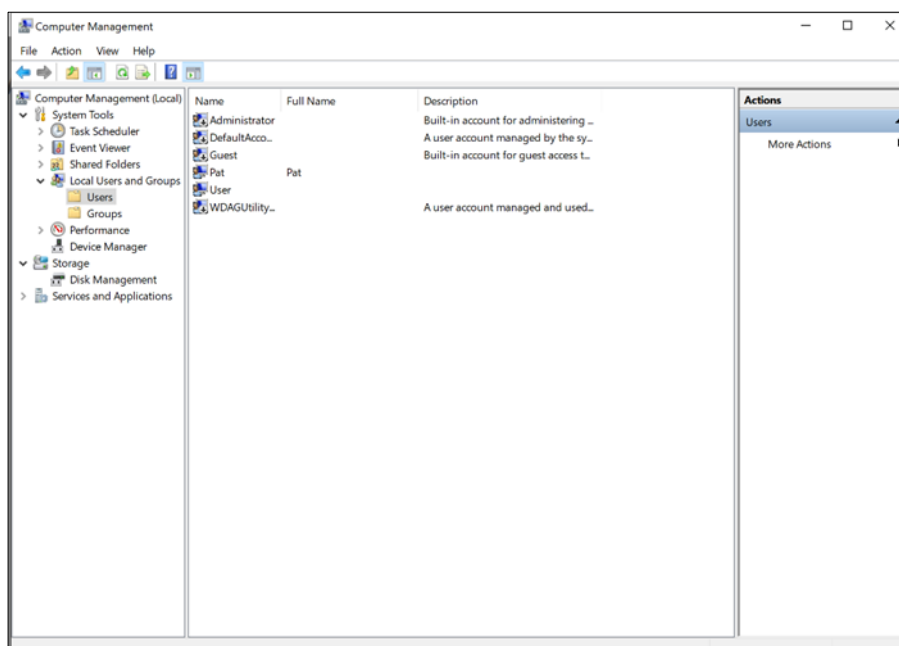

2. Create user groups that match the HMI User Groups (Operator, Engineer, Administrator). In addition, for SIMATIC Logon to be configured, create the user group Logon_Administrator.

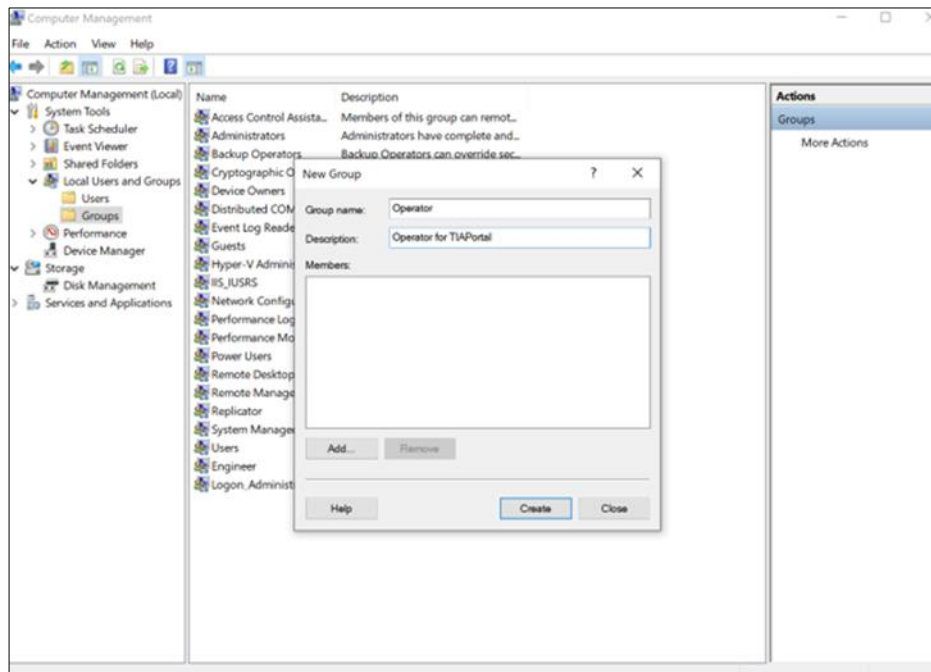

3. Create users

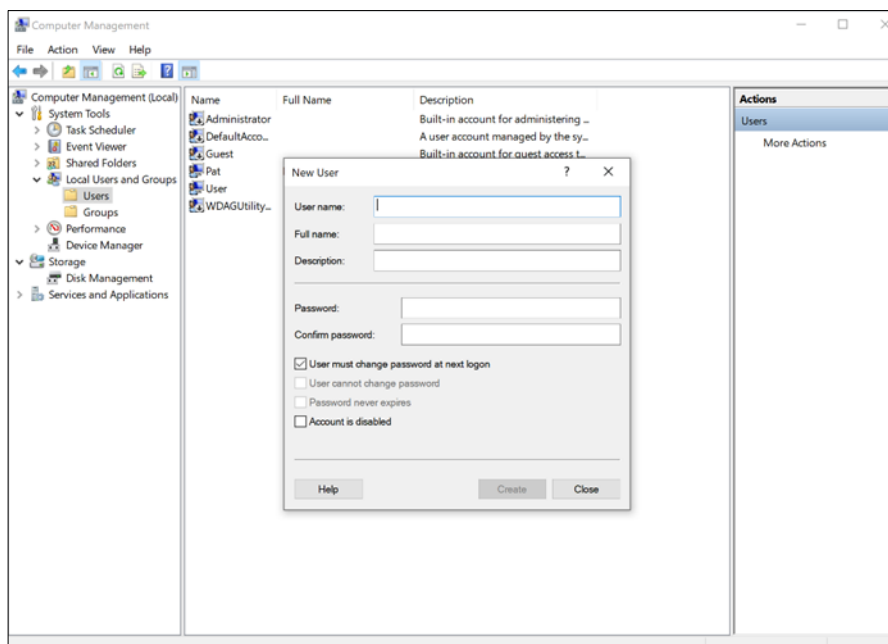

4. Assign users to exactly one group.
 - A user may only be a member of one user group in WinCC. When a user is a member of several user groups on the server, only one of these user groups can be made known in WinCC.
 - Users is a predefined group in Windows. Any new user created in Windows is automatically a member of the Users group. Therefore, when you assign the user a new group, it will now be a member of two groups.
 - **Remove this user from the Users group of the operating system to enable logon of this user using SIMATIC Logon.**

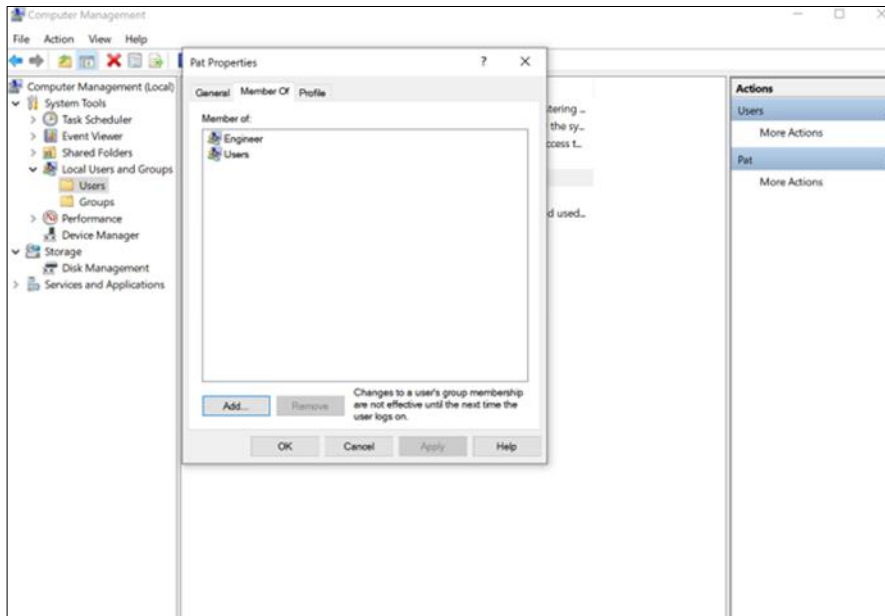

5. For SIMATIC Logon configuration, a user needs to be created that is a member of the Windows Administrators or Power Users group as well as the new user group Logon_Administrator. This user will be used to set up SIMATIC Logon.
6. Install SIMATIC Logon following the installation prompts.
7. Attach the SIMATIC Logon USB license key to the computer.



8. Open the SIMATIC Logon folder by clicking the SIMATIC Logon icon.
9. Click the Configure SIMATIC Logon icon and log in with the user assigned to the Logon_Administrator group.

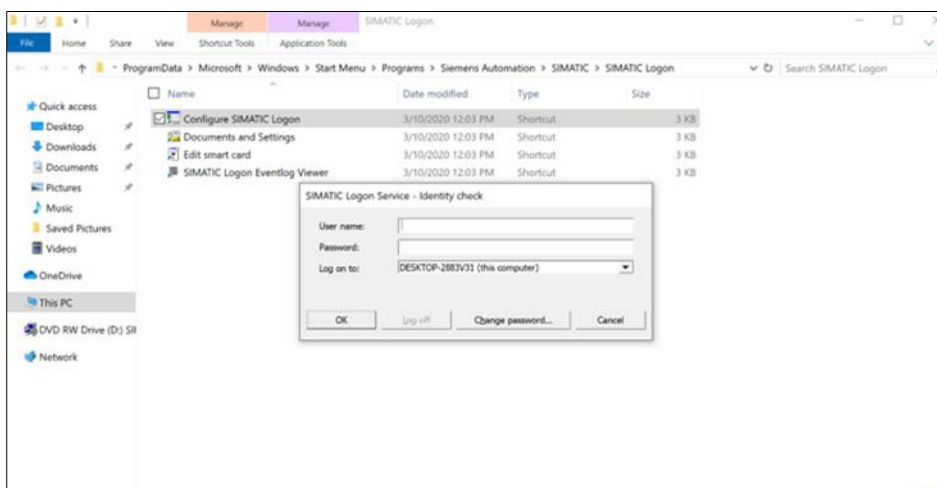

- The General tab allows the language, data/time, default user logon, and password expiration settings to be specified. These options can be left at their defaults.

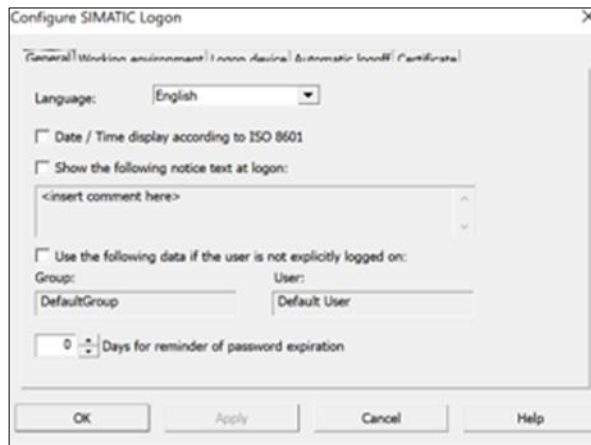

- In The Working environment tab, check the from this computer or from a Windows domain checkbox so that SIMATIC Logon will provide the user data from this computer.

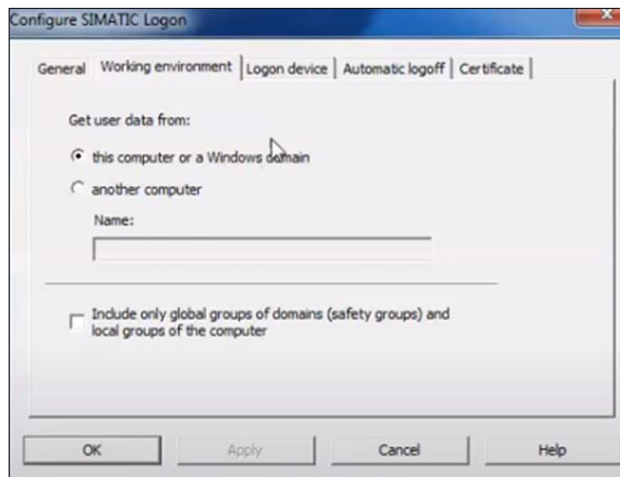

- The Logon device tab allows log on via an external device, such as a keyboard or smart card reader. These options can be left at their defaults.

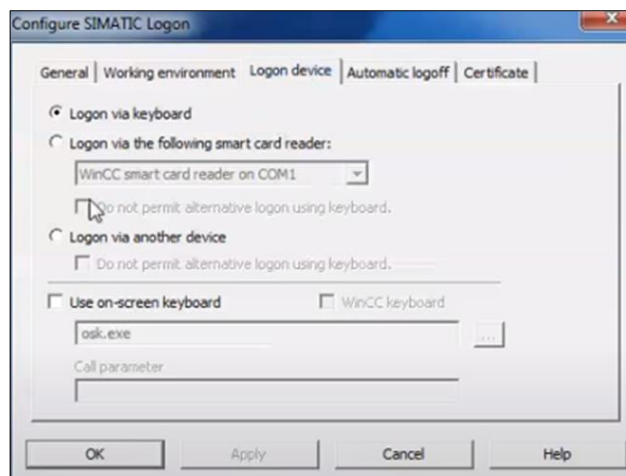

- The Automatic logoff tab allows SIMATIC to automatically log off a user after the specified inactivity time.

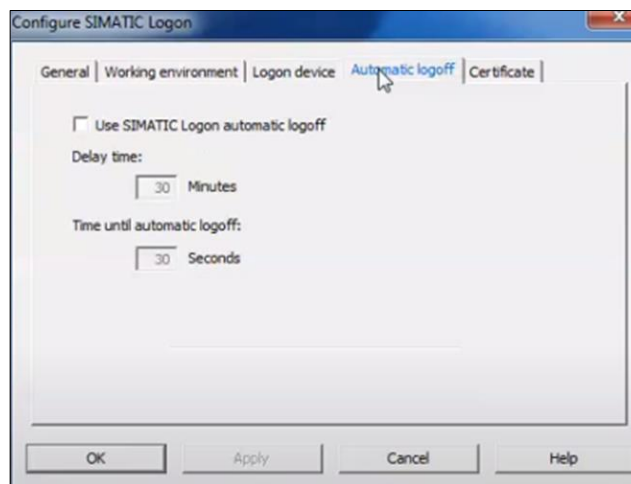

14. Using TIA Portal, Enable SIMATIC Logon for the HMI

- Go to HMI Folder > Runtime Settings > User Administration >
- Check the box Enable SIMATIC Logon
- Make sure to identify use of either Windows domain or Windows computer, based on if SIMATIC was installed on a Windows server or Windows 7, respectively.
- Enter the server information (either the IP Address or server name). Note: Only use an IP Address if the address is static.
- Unselect encrypted transfer.
- Download the TIA Portal changes to the HMI.

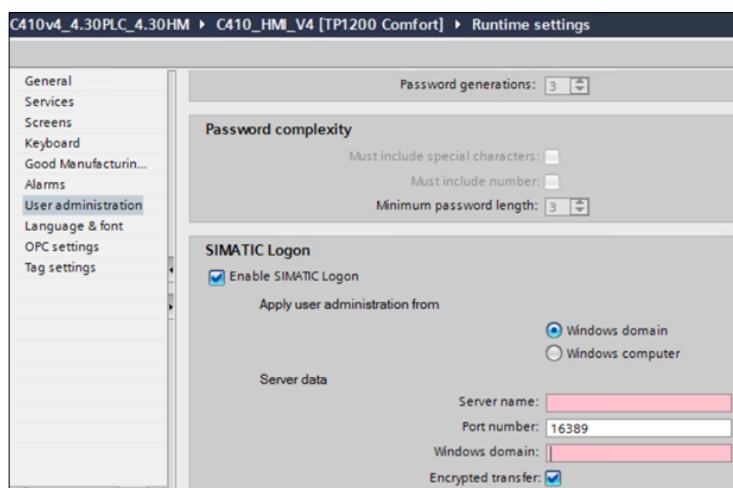

Note: SIMATIC Logon (V1.5 SP3 and later) supports secure encrypted communication to HMI device version V13 SP1 and higher. If encryption is desired, refer to the manual and Siemens Support ID=109480490 (<https://support.industry.siemens.com/cs/document/109480490/>).

For encrypted communication, a SIMATIC logon certificate is compared with a local certificate. The certificate location is configured in the SIMATIC Logon configuration, certificate tab.

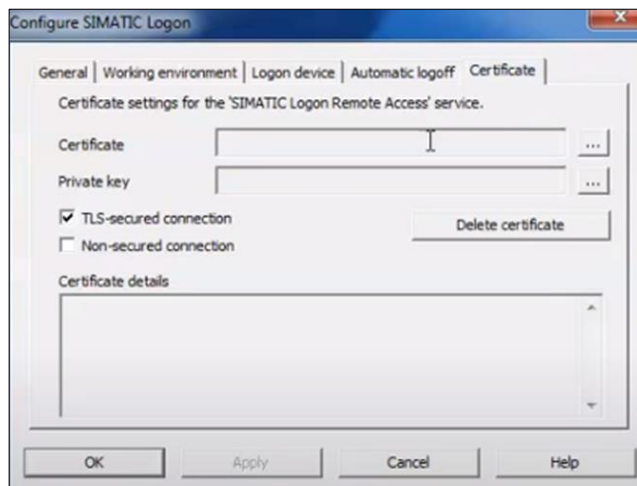

20.13 If TIA Portal: Audit trail

1. Install Audit trail license.
2. HMI Folder > Runtime Settings > Good Manufacturing Practice > Click Check Box

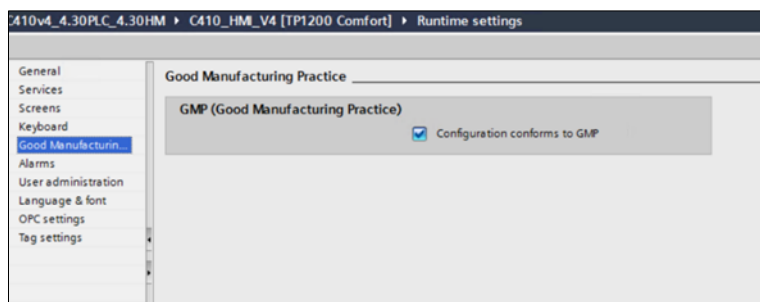

3. (Optional) Repligen has pre-selected GMP Relevant parameters. However, if additional parameters are desired, do the following:
 - a. Selected the desired tag in the HMI Tag Database
 - b. In the Good Manufacturing Practice property area, check the GMP relevant checkbox. When the value changes, it will now be captured in the audit log.
 - c. If desired, select the Comment required checkbox
 - d. If desired, specify a Confirmation type. For example, Electronic Signature.

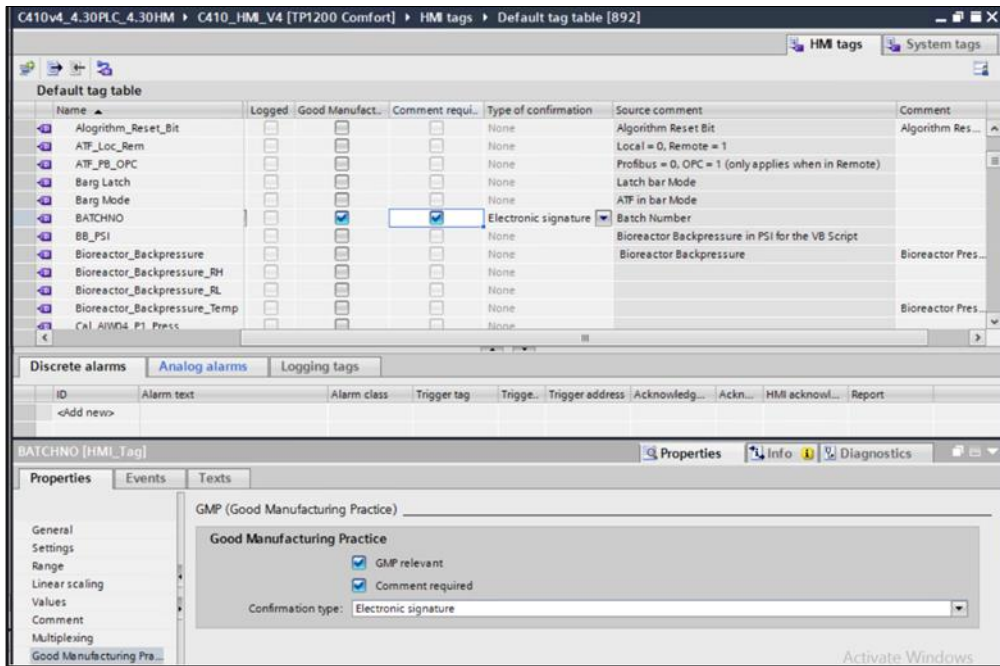

4. (Optional) Repligen has pre-created VB scripts to log sets of parameters that are not updated until an Accept Change pushbutton is pressed. (For example, Screen 50 – Basic Setup). These changes are recorded using the event NotifyUserAction.
 - a. See VB Script S50_Accept and S50_Open for Screen 50.
 - b. See VB Script S51_Accept and S51_Open for Screen 51.
 - c. See VB Script S52_Accept and S52_Open for Screen 52.
 - d. See VB Script S53_Accept and S53_Open for Screen 53.

Note: If a button press is being directly logged, the Click Event can run the NotifyUserAction.



5. In the Historical Data area, the third tab Audit Trail becomes visible once the runtime settings GMP checkbox is selected. This tab is used to specify the storage location.

Note: The storage location should be a local location, NOT a network location here. If a network drive is specified here, there is no guarantee for reliable operation. Instead, a system function will be used to move the log to the network from the local drive.

20.14 TIA Portal: Storing the Audit trail to a network location

Note: Remote Audit Trail uses the Windows Shared Folder functionality. By default, Windows 10 blocks the SMB protocol required the share folders with the Windows CE environment running on the HMI. Therefore, Windows 10 is not recommended for a remote location.

1. Repligen has pre-created a Scheduled task NetworkAuditLog with a disabled trigger. The trigger can be changed to the desired duration (Daily, Weekly, etc.) as shown below:

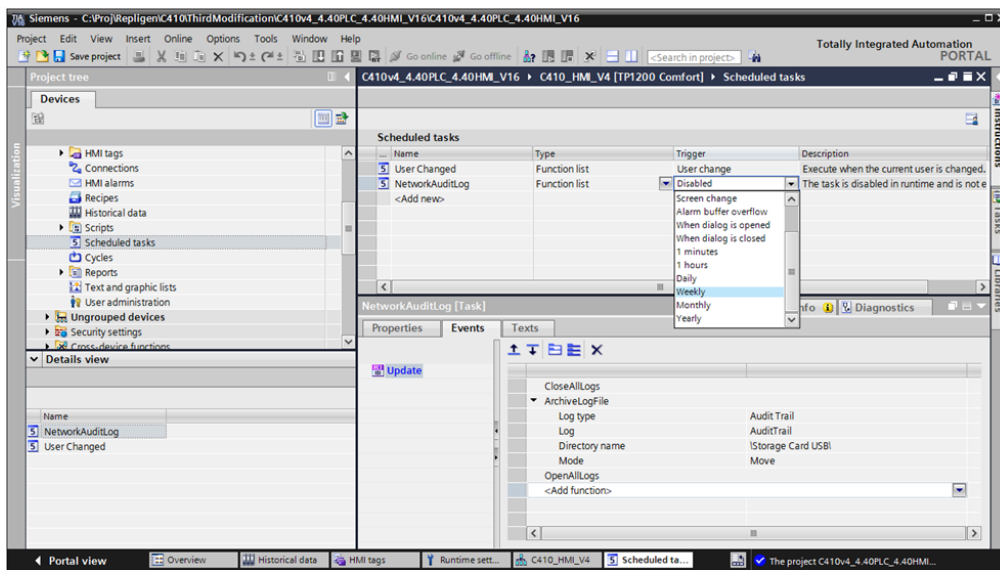

2. The scheduled task uses the following events to transfer data to the network.
 - a. The Historical data event, CloseAllLogs to prepare for transfer
 - b. The Historical data event, ArchiveLogFile, which moves or copies a log to another storage location for long-term logging.
 - c. The Historical data event, OpenAllLogs to resume audit trail writes.

Note: When opened logs are closed, the logging continues. Values to be logged are cached. Once the log is opened, the buffered process values are added to the log.

3. In ArchiveLogFile event, change the Directory name field to the desired network location by specifying \\NetworkComputerName\YourNetworkFolderName.

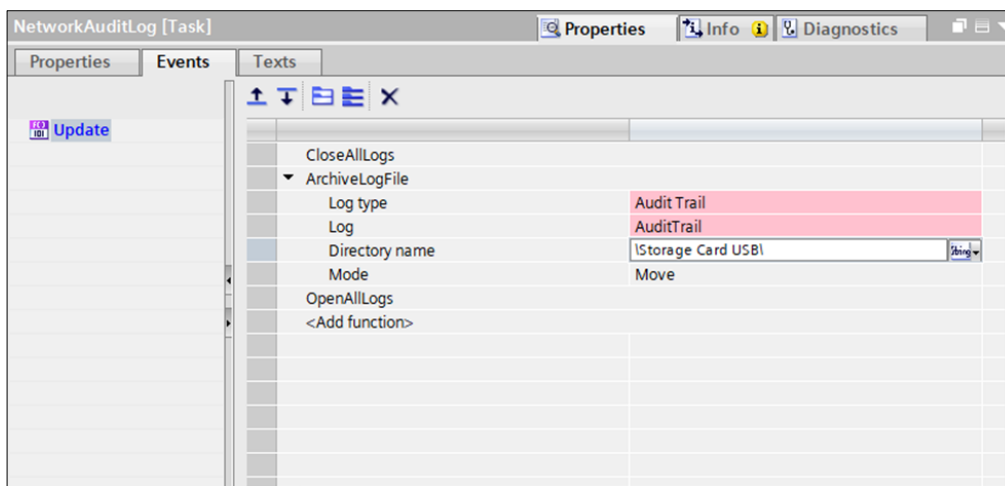

Note: For audit trails, the Mode should always be Moved to be in compliance with FDA guidelines.

4. Download the TIA Portal changes to the PLC.
5. **For the following steps, consult your IT group for your specific IT policies. Some steps may have to be modified to meet those policies:**
6. On the remote computer \\NetworkComputerName create a folder YourNetworkFolderName in the root (C:\) directory.
7. Right click to access the properties, navigate to the Sharing tab and select Share.

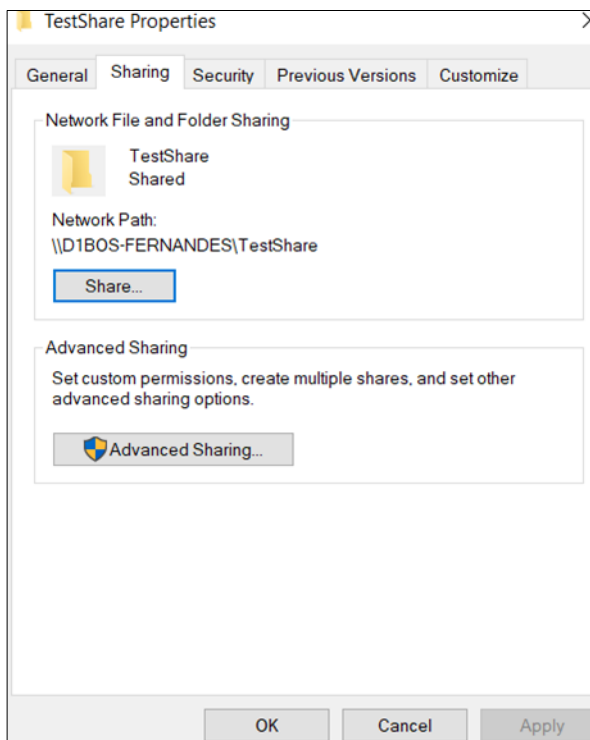

8. In Advanced Sharing... select Permissions and select Everyone.

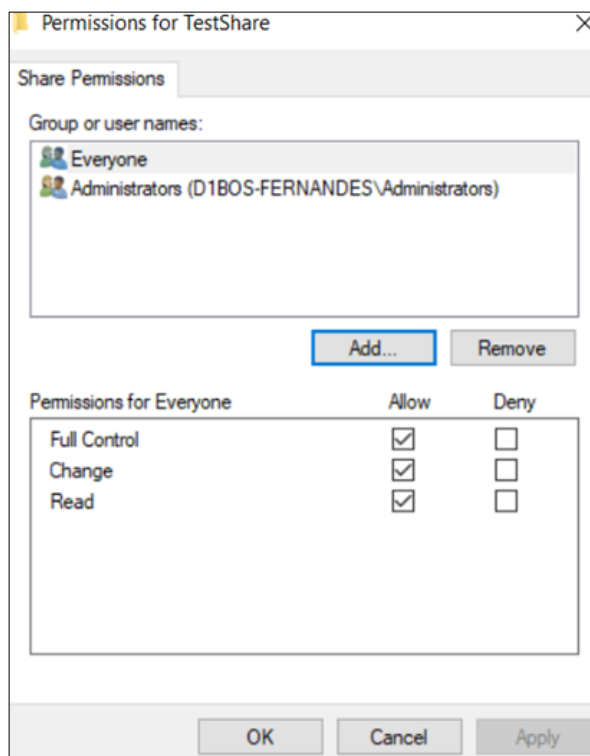

9. Go to Windows Control Panel > Network and Sharing Center > Advanced Sharing Settings:
 10. As appropriate for Private, Public and/or Domain networks, Turn on file and printer sharing
 11. For All Networks > Password Protected Sharing, Turn off password protected sharing.
- If your IT policy prohibits this, then on the HMI, Administration screen, select Close Application to access the Windows CE environment.
 - In file explorer enter the desired \\NetworkComputerName\NetworkFolder
 - A Windows prompt will ask for the username and password credentials to access the network computer. Store the username and password, so that the HMI will be able to access the location.

12. As needed, unblock firewall settings that restrict file sharing.

20.15 TIA Portal: Network Time Protocol (NTP) Server Configuration

Note: The following steps are provided to configure the PLC and HMI to follow an existing NTP server. The pre-requisite is that an NTP server is configured and accessible. If difficulties arise, consult with your IT group to confirm that the inbound and outbound rules for the NTP server allow traffic for UDT port 123.

1. In the PLC area, Device Configuration, click on the PROFINET port of the CPU Module 1.
2. A PROFINET Interface_1 [Module] properties area will be displayed on the bottom of TIA Portal. Select the Time Synchronization Menu.
3. Select the Enable time synchronization via NTP server box and provide the IP Address.

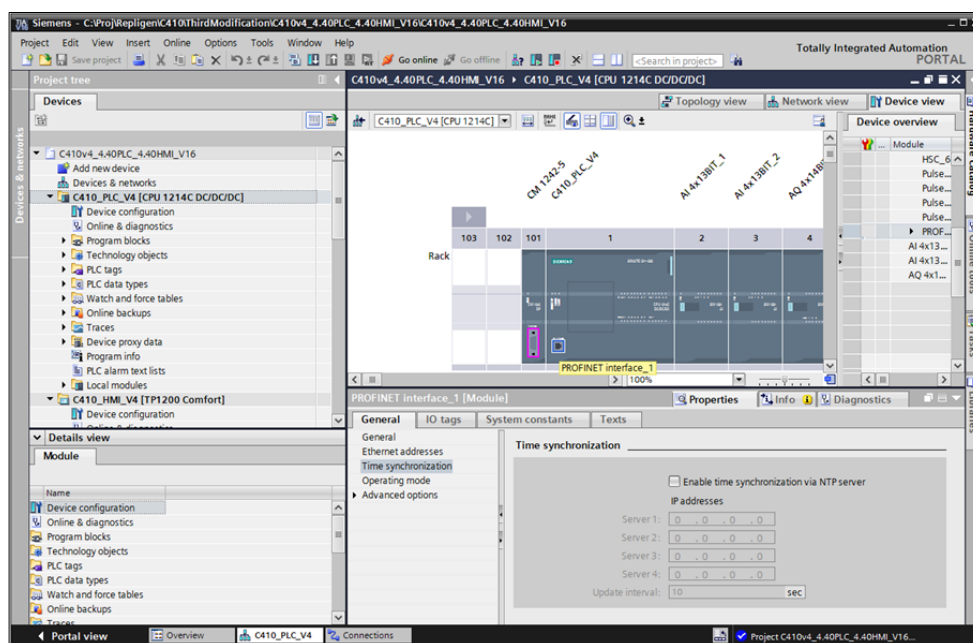

4. Select Time of day, and specify the Time zone and Daylight savings.

- In the HMI Area, Connections, change the HMI time synchronization mode from Master to None.

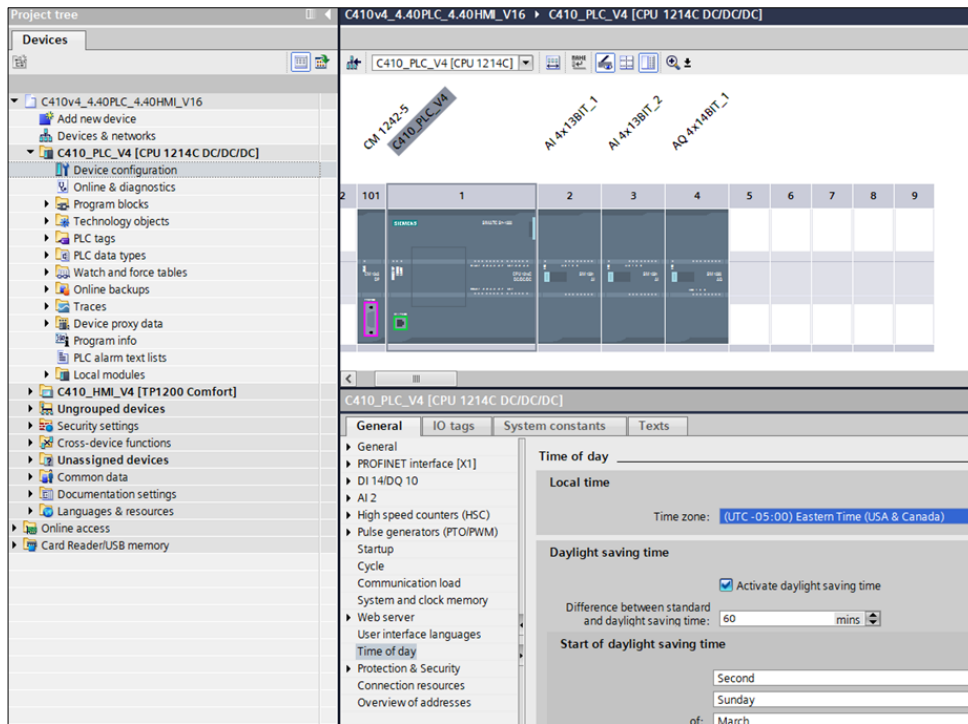

- For Screen 60 – Administration, disable the Set Date and Time buttons (both the Date button and Time button) by unselecting the Allow operator control checkbox in the Security menu.

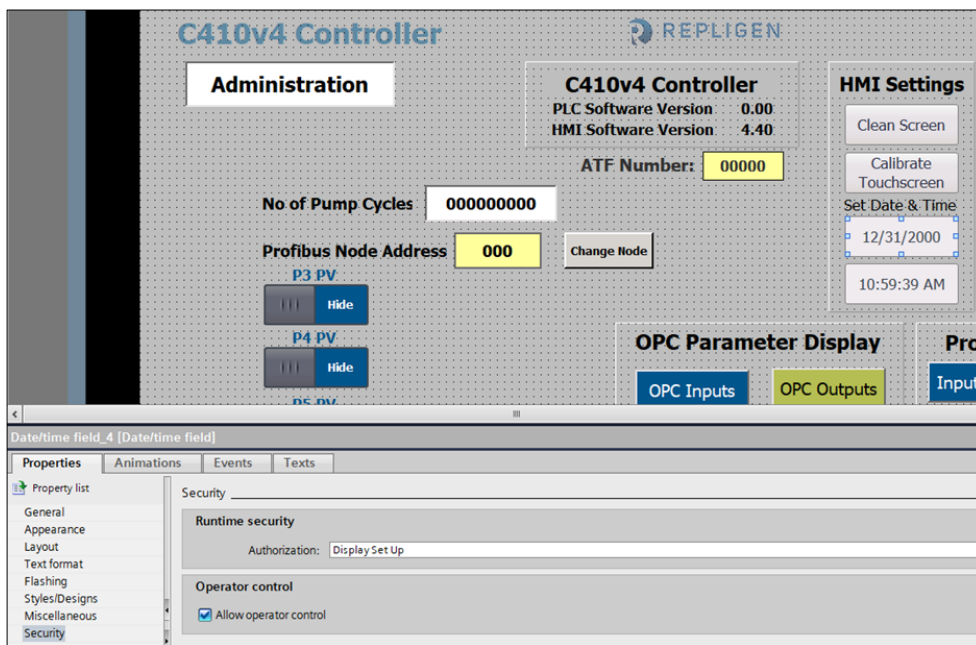

- Optionally, change the appearance of the buttons so visibly they look disabled.
- Download the TIA Portal updates to the PLC and HMI.
- On the HMI, logon as a member of the Administrator user group (Default: Admin), navigate to the Administration screen, and select Close Application to access the Windows CE environment.

10. Open the HMI Control Panel and select Profinet.



11. Select the NTP tab.

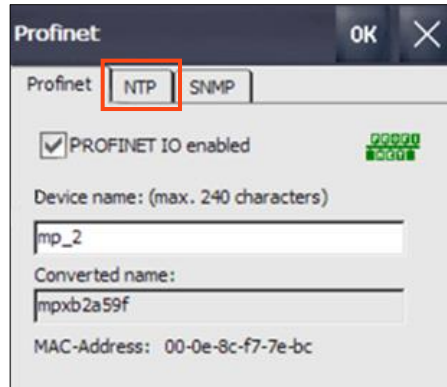

12. Select Automatically synchronize with a time server, enter the desired Update rate, and press Configure to specify the NTP address.

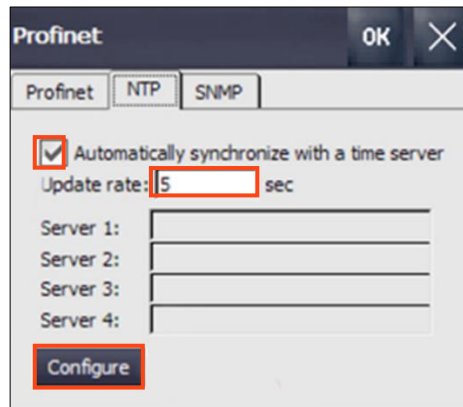

13. Specify the NTP IP address and desired name and press Test to confirm functionality and then OK.

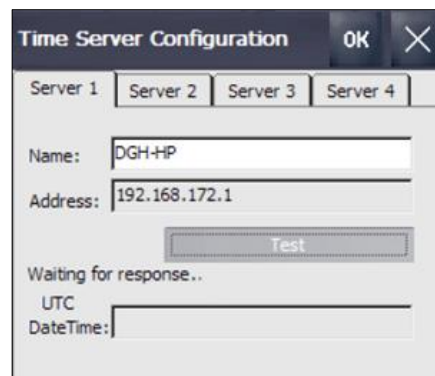

21. Troubleshooting

Integrating the Siemens WinCC HMI into an existing network for user administration, remote audit trail storage, and NTP time server synchronization often requires a collaborative effort with the IT group. Often corporate IT policies need to be considered, as well as firewall restrictions. Similarly, if difficulties occur using TIA portal to communicate with the PLC and/or HMI, it is often a firewall that is restricting the required communication port. Alternatively, the SIMATIC Automation Tool can be downloaded from the Siemens website and has a network tool that may help scan the network when communications cannot be established.

22. Index

Alternating tangential flow	7	Parts list	105
Appendix 20, 35, 50, 58, 61, 62, 85, 90, 101, 103, 105		Spares	106
Components..... 8, 9, 14, 15, 16, 103		Sterilization..... 46, 47, 48	
Declaration of Conformity	103	Troubleshooting	129
Implementation instructions	108	Utility	37
Maintenance	49, 57	Warning ..24, 26, 33, 58, 59, 60, 67, 75, 78, 95, 98	
Note9, 10, 16, 17, 19, 41, 42, 46, 49, 59, 60, 64, 65, 93, 94, 101			